

Needle roller bearings



® SKF is a registered trademark of the SKF Group.

© SKF 2009

The contents of this catalogue are the copyright of the publisher and may not be reproduced (even extracts) unless prior written permission is granted. Every care has been taken to ensure the accuracy of the information contained in this catalogue but no liability can be accepted for any loss or damage whether direct, indirect or consequential arising out of the use of the information contained herein.

PUB BU/P1 06003 EN · November 2009

This publication supersedes publication 4703/I E.

Printed in Germany on environmentally friendly paper.

Principles of bearing selection and application	13
Needle roller and cage assemblies	57
Drawn cup needle roller bearings	75
Needle roller bearings with machined rings.....	97
Alignment needle roller bearings	141
Needle roller thrust bearings and bearing washers	151
Combined needle roller bearings.....	169
Needle roller bearing components	195
Track runner bearings	215

1

2

3

4

5

6

7

8

9

Contents

Foreword	5
Unit conversions	7
SKF – the knowledge engineering company	8
1 Principles of bearing selection and application	13
Bearing terminology.....	14
Bearing types.....	17
Bearing life and loads.....	32
Friction.....	34
Speeds.....	35
Bearing data – general.....	36
Application of bearings.....	48
Lubrication.....	52
2 Needle roller and cage assemblies	57
Product tables	
2.1 Needle roller and cage assemblies	64
3 Drawn cup needle roller bearings	75
Product tables	
3.1 Drawn cup needle roller bearings	82
4 Needle roller bearings with machined rings	97
Product tables	
4.1 Needle roller bearings with machined rings with flanges, without an inner ring	106
4.2 Needle roller bearings with machined rings with flanges, with an inner ring	122
4.3 Needle roller bearings with machined rings without flanges, without an inner ring ..	134
4.4 Needle roller bearings with machined rings without flanges, with an inner ring	138
5 Alignment needle roller bearings	141
Product tables	
5.1 Alignment needle roller bearings without an inner ring	146
5.2 Alignment needle roller bearings with an inner ring.....	148
6 Needle roller thrust bearings and bearing washers	151
Product tables	
6.1 Needle roller and cage thrust assemblies and appropriate washers.....	162
6.2 Needle roller thrust bearings with a centring spigot and appropriate washers.....	166

7 Combined needle roller bearings	169
Product tables	
7.1 Needle roller / angular contact ball bearings	174
7.2 Needle roller / thrust ball bearings, full complement thrust bearing	184
7.3 Needle roller / thrust ball bearings, thrust bearing with a cage	186
7.4 Needle roller / cylindrical roller thrust bearings	192
8 Needle roller bearing components	195
Product tables	
8.1 Needle roller bearing inner rings	200
8.2 Needle rollers	206
8.3 Radial shaft seals with low cross sectional height	212
9 Track runner bearings	215
Product tables	
9.1 Support rollers without flange rings, without an inner ring	226
9.2 Support rollers without flange rings, with an inner ring	228
9.3 Support rollers with flange rings, with an inner ring	230
9.4 Cam followers	252
Product index	258



The SKF brand now stands for more than ever before, and means more to you as a valued customer.

While SKF maintains its leadership as the hallmark of quality bearings throughout the world, new dimensions in technical advances, product support and services have evolved SKF into a truly solutions-oriented supplier, creating greater value for customers.

These solutions encompass ways to bring greater productivity to customers, not only with breakthrough application-specific products, but also through leading-edge design simulation tools and consultancy services, plant asset efficiency maintenance programmes, and the industry's most advanced supply management techniques.

The SKF brand still stands for the very best in rolling bearings, but it now stands for much more.

SKF – the knowledge engineering company

Foreword

Many bearing arrangements have limited radial space, but require bearings having a high load carrying capacity and a high degree of stiffness. SKF needle roller bearings with their low cross section fulfil these requirements. They also provide an economical solution to these challenges if the shaft or housing bore can serve as raceways.

SKF track runner bearings are an excellent choice for all types of cam drives, tracks, conveyor systems etc. where guidance is required.

For motorsport applications, SKF Racing has been using customized, high-performance needle roller bearings for many years. These special needle roller bearings are used in the most demanding Formula One applications, such as gearboxes. Using different advanced materials, coatings and designs, SKF's advanced engineering knowledge can improve the performance and reliability of virtually any application.

SKF supplies needle roller bearings as well as track runner bearings in many designs, series and sizes, which make them appropriate for various operating conditions.

This catalogue presents the current standard assortment of SKF needle roller bearings, track runner bearings and radial shaft seals with low cross sectional height.

Structure of the catalogue

The catalogue starts with general product information followed by nine main chapters, which are marked with numbered blue tabs in the right margin:

- Chapter 1 provides bearing terminology and types as well as selection, design and application recommendations.

- Chapters 2 to 8 describe the various needle roller bearing types and their associated components. Each chapter contains descriptions of the products as well as product tables, which list data for selecting a bearing and designing the bearing arrangement.
- Similarly, chapter 9 presents the various designs and series of track runner bearings, incorporating needle or cylindrical rollers.

The index at the end lists all products presented in this catalogue in alphanumeric order.

About the data in this catalogue

The data in this catalogue relates to SKF's state-of-the-art technology as of mid-2009. The data may differ from that shown in earlier catalogues because of revised methods of calculation, redesign or technological developments.

SKF reserves the right to make continuing improvements to SKF products with respect to materials, design and manufacturing methods, as well as changes necessitated by technological developments.

The units used in this catalogue are in accordance with ISO (International Organization for Standardization) standard 1000:1992, and SI (Système International d'Unités). A table for unit conversions can be found on **page 7**.

Other SKF catalogues

The total SKF product portfolio is much broader than only needle roller bearings and track runner bearings. Product information is also available via the SKF website at www.skf.com. The *SKF Interactive Engineering Catalogue* provides not only product information, but also online

calculation tools, CAD drawings in various formats, and search and selection functions.

The main printed SKF catalogues are:

- General Catalogue
- High-precision bearings
- Y-bearings and Y-bearing units
- Spherical plain bearings and rod ends
- Bearing housings
- Slewing bearings
- Linear motion standard range
- SKF Maintenance and Lubrication Products
- Centralized lubrication systems
- Industrial shaft seals
- SKF Power transmission products

For more information about SKF products and services, contact your local SKF representative or SKF Authorized Distributor.

More advantages

SKF aims to deliver industry-leading, high value products, services and knowledge-engineered solutions. Many capabilities contribute to the overall value customers receive in making SKF their supplier of choice, such as:

- simplified bearing selection
- short delivery times
- worldwide availability
- commitment to product innovation
- state-of-the-art application solutions
- extensive engineering and technology knowledge in virtually every industry

Unit conversions

Quantity	Unit	Conversion			
Length	inch	1 mm	0,03937 in	1 in	25,40 mm
	foot	1 m	3,281 ft	1 ft	0,3048 m
	yard	1 m	1,094 yd	1 yd	0,9144 m
	mile	1 km	0,6214 mile	1 mile	1,609 km
Area	square inch	1 mm ²	0,00155 sq.in	1 sq.in	645,16 mm ²
	square foot	1 m ²	10,76 sq.ft	1 sq.ft	0,0929 m ²
Volume	cubic inch	1 cm ³	0,061 cub.in	1 cub.in	16,387 cm ³
	cubic foot	1 m ³	35 cub.ft	1 cub.ft	0,02832 m ³
	imperial gallon	1 l	0,22 gallon	1 gallon	4,5461 l
	U.S. gallon	1 l	0,2642 U.S. gallon	1 U.S. gallon	3,7854 l
Velocity, speed	foot per second	1 m/s	3,28 ft/s	1 ft/s	0,30480 m/s
	mile per hour	1 km/h	0,6214 mile/h (mph)	1 mile/h (mph)	1,609 km/h
Mass	ounce	1 g	0,03527 oz	1 oz	28,350 g
	pound	1 kg	2,205 lb	1 lb	0,45359 kg
	short ton	1 tonne	1,1023 short ton	1 short ton	0,90719 tonne
	long ton	1 tonne	0,9842 long ton	1 long ton	1,0161 tonne
Density	pound per cubic inch	1 g/cm ³	0,0361 lb/cub.in	1 lb/cub.in	27,680 g/cm ³
Force	pound-force	1 N	0,225 lbf	1 lbf	4,4482 N
Pressure, stress	pounds per square inch	1 MPa	145 psi	1 psi	6,8948 × 10 ³ Pa
Moment	inch pound-force	1 Nm	8,85 in.lbf	1 in.lbf	0,113 Nm
Power	foot-pound per second	1 W	0,7376 ft lbf/s	1 ft lbf/s	1,3558 W
	horsepower	1 kW	1,36 HP	1 HP	0,736 kW
Temperature	degree	Celsius	$t_C = 0,555 (t_F - 32)$	Fahrenheit	$t_F = 1,8 t_C + 32$

SKF – the knowledge engineering company

From the company that invented the self-aligning ball bearing more than 100 years ago, SKF has evolved into a knowledge engineering company that is able to draw on five technology platforms to create unique solutions for its customers. These platforms include bearings, bearing units and seals, of course, but extend to other areas including: lubricants and lubrication systems, critical for long bearing life in many applications; mechatronics that combine mechanical and electronics knowledge into systems for more effective linear motion and sensorized solutions; and a full range of services, from design and logistics support to conditioning monitoring and reliability systems.

Though the scope has broadened, SKF continues to maintain the world's leadership in the design, manufacture and marketing of rolling bearings, as well as complementary products such as radial seals. SKF also holds an increasingly important position in the market for linear motion products, high-precision aerospace bearings, machine tool spindles and plant maintenance services.

The SKF Group is globally certified to ISO 14001, the international standard for environmental management, as well as OHSAS 18001, the health and safety management standard. Individual divisions have been approved for quality certification in accordance with either ISO 9001 or other customer specific requirements.

With over 100 manufacturing sites worldwide and sales companies in 70 countries, SKF is a truly international corporation. In addition, our distributors and dealers in some 15 000 locations around the world, an e-business marketplace and a global distribution system put SKF close to customers for the supply of both products and services. In essence, SKF solutions are available wherever and whenever customers need them. Overall, the SKF brand and the corporation are stronger than ever. As the knowledge engineering company, we stand ready to serve you with world-class product competencies, intellectual resources, and the vision to help you succeed.

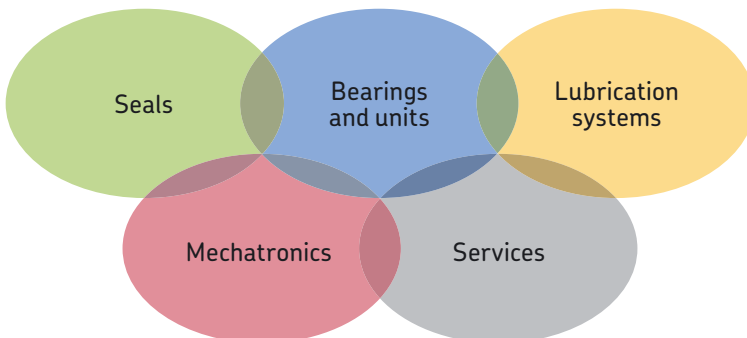



© Airbus – photo: e'm company, H. Goussé

Evolving by-wire technology

SKF has a unique expertise in fast-growing by-wire technology, from fly-by-wire, to drive-by-wire, to work-by-wire. SKF pioneered practical fly-by-wire technology and is a close working partner with all aerospace industry leaders. As an example, virtually all aircraft of the Airbus design use SKF by-wire systems for cockpit flight control.



SKF is also a leader in automotive by-wire technology, and has partnered with automotive engineers to develop two concept cars, which employ SKF mechatronics for steering and braking. Further by-wire development has led SKF to produce an all-electric forklift truck, which uses mechatronics rather than hydraulics for all controls.



Harnessing wind power

The growing industry of wind-generated electric power provides a source of clean, green electricity. SKF is working closely with global industry leaders to develop efficient and trouble-free turbines, providing a wide range of large, highly specialized bearings and condition monitoring systems to extend equipment life of wind farms located in even the most remote and inhospitable environments.



Working in extreme environments

In frigid winters, especially in northern countries, extreme sub-zero temperatures can cause bearings in railway axleboxes to seize due to lubrication starvation. SKF created a new family of synthetic lubricants formulated to retain their lubrication viscosity even at these extreme temperatures. SKF knowledge enables manufacturers and end user customers to overcome the performance issues resulting from extreme temperatures, whether hot or cold. For example, SKF products are at work in diverse environments such as baking ovens and instant freezing in food processing plants



Developing a cleaner cleaner

The electric motor and its bearings are the heart of many household appliances. SKF works closely with appliance manufacturers to improve their products' performance, cut costs, reduce weight, and reduce energy consumption. A recent example of this cooperation is a new generation of vacuum cleaners with substantially more suction. SKF knowledge in the area of small bearing technology is also applied to manufacturers of power tools and office equipment.



Maintaining a 350 km/h R&D lab

In addition to SKF's renowned research and development facilities in Europe and the United States, Formula One car racing provides a unique environment for SKF to push the limits of bearing technology. For over 50 years, SKF products, engineering and knowledge have helped make Scuderia Ferrari a formidable force in F1 racing. (The average racing Ferrari utilizes more than 150 SKF components.) Lessons learned here are applied to the products we provide to automakers and the aftermarket worldwide.



Delivering Asset Efficiency Optimization

Through SKF Reliability Systems, SKF provides a comprehensive range of asset efficiency products and services, from condition monitoring hardware and software to maintenance strategies, engineering assistance and machine reliability programmes. To optimize efficiency and boost productivity, some industrial facilities opt for an Integrated Maintenance Solution, in which SKF delivers all services under one fixed-fee, performance-based contract.



Planning for sustainable growth

By their very nature, bearings make a positive contribution to the natural environment, enabling machinery to operate more efficiently, consume less power, and require less lubrication. By raising the performance bar for our own products, SKF is enabling a new generation of high-efficiency products and equipment. With an eye to the future and the world we will leave to our children, the SKF Group policy on environment, health and safety, as well as the manufacturing techniques, are planned and implemented to help protect and preserve the earth's limited natural resources. We remain committed to sustainable, environmentally responsible growth.

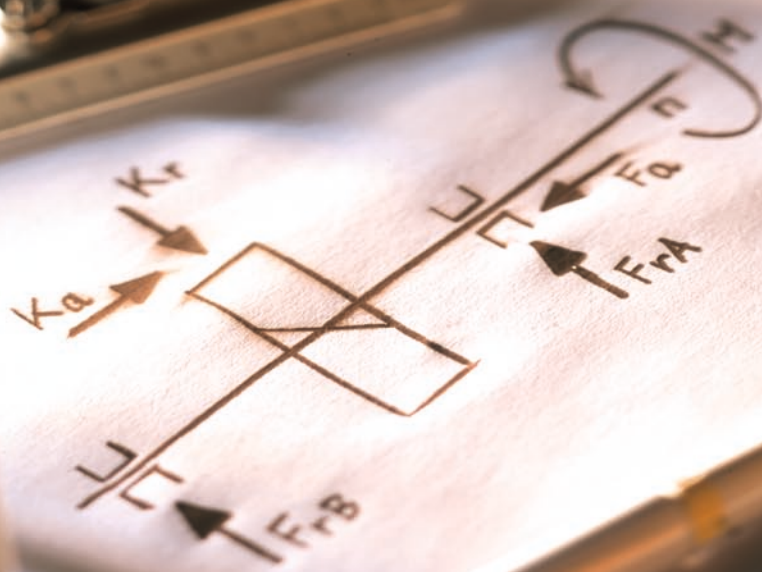

Principles of bearing selection and application

Bearing terminology	14
Bearing types	17
Needle roller bearings.....	17
Track runner bearings.....	27
Bearing life and loads	32
Bearing life.....	32
Equivalent bearing loads.....	32
Static bearing loads.....	32
Requisite minimum load	32
Friction	34
Estimating the frictional moment.....	34
Speeds	35
Bearing data – general	36
Tolerances.....	36
Internal clearance.....	42
Cages.....	43
Seals.....	43
Materials.....	43
Supplementary designations.....	46
Application of bearings	48
Design of associated components	48
Surface roughness of bearing seats.....	50
Raceways on shafts and in housings.....	50
Lubrication	52
The SKF traffic light concept.....	52
Lubricating greases.....	53

Bearing terminology

To better understand frequently used needle roller and track runner bearing terms, definitions are provided in **fig. 1** to **6**.

Drawn cup needle roller bearings (→ fig. 1)

- 1 Drawn cup
- 2 Lubrication hole
- 3 Closed end
- 4 Raceway
- 5 Needle roller and cage assembly
- 6 Open end

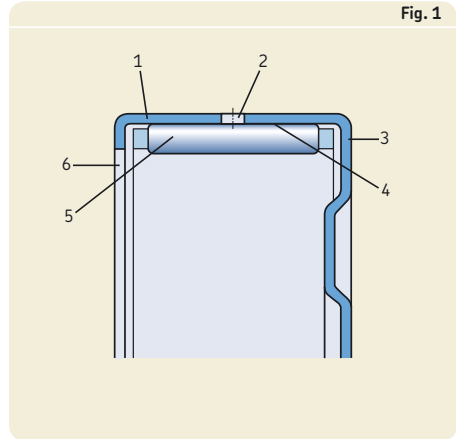

Needle roller bearings with machined rings (→ fig. 2)

- 1 Outer ring
- 2 Lubrication hole
- 3 Annular groove
- 4 Raceway
- 5 Integral flange
- 6 Seal
- 7 Inner ring
- 8 Needle roller and cage assembly

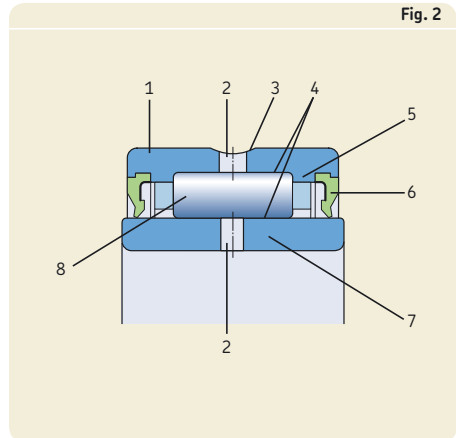

Needle roller thrust bearings with a centring spigot (→ fig. 3)

- 1 Centring spigot
- 2 Needle roller and cage thrust assembly
- 3 Raceway

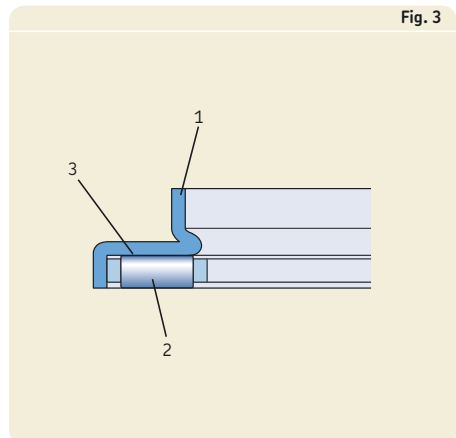
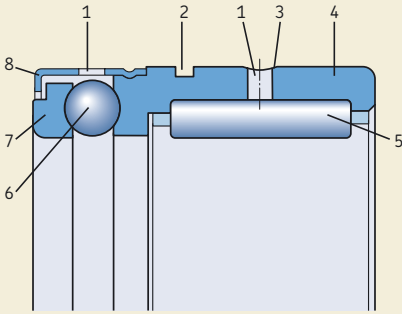

Fig. 4



Needle roller / thrust ball bearings (→ fig. 4)

- 1 Lubrication hole
- 2 Snap ring groove
- 3 Annular groove
- 4 Outer ring
- 5 Needle roller and cage assembly
- 6 Thrust rolling element: ball (full complement)
- 7 Shaft washer
- 8 Steel cover

Fig. 5

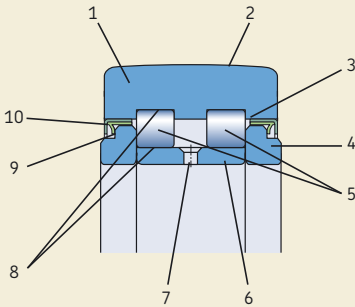

Support rollers (→ fig. 5)

- 1 Outer ring
- 2 Outer ring running surface
- 3 Integral flange
- 4 Loose flange ring
- 5 Rolling element: cylindrical roller (two rows full complement)
- 6 Inner ring
- 7 Lubrication hole
- 8 Raceway
- 9 Contact seal
- 10 Sheet metal angle ring

Fig. 6

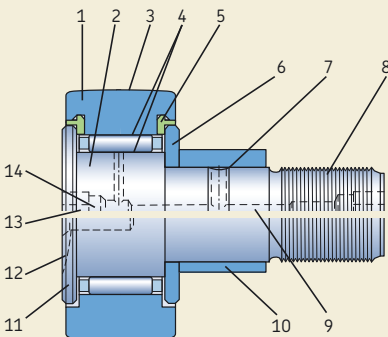

Cam followers (→ fig. 6)

- 1 Outer ring
- 2 Stud (pin)
- 3 Outer ring running surface
- 4 Raceway
- 5 Axial sliding ring
- 6 Pressed-on flange ring
- 7 Annular groove
- 8 Thread
- 9 Lubrication duct
- 10 Eccentric collar
- 11 Head/ integral flange
- 12 Slot
- 13 Recessed hexagon
- 14 Hole for grease fitting



Bearing types

Needle roller bearings

Needle roller bearings are bearings with cylindrical rollers that are small in diameter. In spite of their low cross section, needle roller bearings have a high load carrying capacity and are therefore extremely suitable for bearing arrangements where radial space is limited.

SKF supplies needle roller bearings in different designs and in a wide range of sizes, which are appropriate for different applications. In addition to customized designs, they comprise the following types and components:

- needle roller and cage assemblies
- drawn cup needle roller bearings
- universal joint bearings
- needle roller bearings with machined rings
- alignment needle roller bearings
- needle roller thrust bearings
- bearing washers
- combined needle roller bearings
- needle roller bearing inner rings
- needle rollers
- radial shaft seals with low cross sectional height

Basic information about the different needle roller bearing types, washers, and seals is provided in the following overview.

Bearing types

Needle roller and cage assemblies

See chapter 2 starting on **page 57**

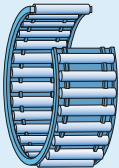
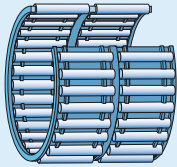
Bearing design Needle roller and cage assemblies	Designation series Inside diameter range	Characteristics
Single row 	K .. TN $F_w = 3 - 45 \text{ mm}$ K $F_w = 14 - 265 \text{ mm}$	Polyamide 66 cage Steel cage
Double row 	K .. ZWTN $F_w = 32 \text{ mm}$ K .. ZW $F_w = 24 - 95 \text{ mm}$	Polyamide 66 cage Steel cage

Drawn cup needle roller bearings

See chapter 3 starting on **page 75**

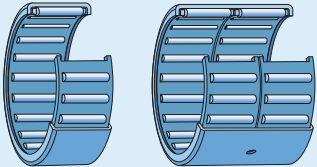
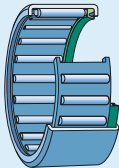
Bearing design Drawn cup needle roller bearings	Designation series Inside diameter range	Characteristics
With open ends, HK series, not sealed 	HK .. TN $F_w = 3 \text{ mm}$ HK $F_w = 4 - 60 \text{ mm}$	Polyamide 66 cage Steel cage, size-dependent single or double row (→ product tables)
With open ends, HK series, sealed on one side 	HK .. RS $F_w = 8 - 50 \text{ mm}$	Steel cage, factory greased

Bearing design

Drawn cup needle roller bearings

Designation series

Inside diameter range

Characteristics

With open ends, HK series, sealed on both sides

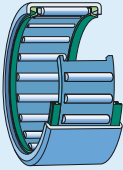

HK ...2RS
 $F_w = 8 - 50$ mm

Steel cage, factory greased

With a closed end, BK series, not sealed

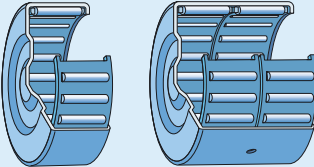

BK .. TN
 $F_w = 3$ mm

Polyamide 66 cage

BK
 $F_w = 4 - 45$ mm

Steel cage, size-dependent single or double row (→ product tables)

With a closed end, BK series, sealed

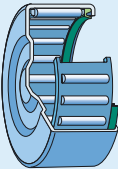

BK .. RS
 $F_w = 10 - 25$ mm

Steel cage, factory greased

With open ends, HN series, full complement, not sealed

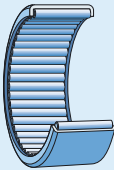

HN
 $F_w = 10 - 50$ mm

Factory greased to secure the rollers

Bearing types

Universal joint bearings

Not covered in this catalogue.

For additional information, refer to the *SKF Interactive Engineering Catalogue*.

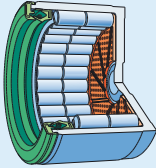
Bearing design Universal joint bearings	Designation series	Characteristics
	BNKB	Specific cold forged cup needle roller bearings for universal joints of commercial vehicle propeller shafts

Needle roller bearings with machined rings

See chapter 4 starting on **page 97**

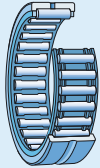
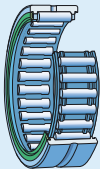
Bearing design Needle roller bearings with machined rings	Designation series Inside diameter range	Characteristics
With flanges, without an inner ring, not sealed		
	NK .. TN $F_w = 5 - 60$ mm NK $F_w = 12 - 110$ mm NKS $F_w = 20 - 75$ mm RNA 49 $F_w = 14 - 160$ mm RNA 69 $F_w = 16 - 110$ mm RNA 48 $F_w = 120 - 415$ mm	Integral flanges, annular groove and one or more lubrication holes (size dependent) If $F_w \leq 10$ mm: with integral closure rings, without lubrication hole or annular groove RNA 69 series bearings with an outside diameter $D \geq 52$ mm are designed as double row bearings
With flanges, without an inner ring, sealed on one side		
	RNA 49.. RS $F_w = 14 - 58$ mm	Integral flanges, annular groove and one or more lubrication holes (size dependent), factory greased

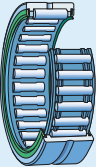
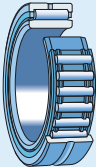
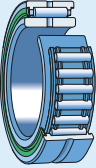
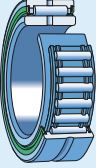
Bearing design Needle roller bearings with machined rings	Designation series Inside/bore diameter range	Characteristics
With flanges, without an inner ring, sealed on both sides	RNA 49...2RS $F_w = 14 - 58$ mm	Integral flanges, annular groove and one or more lubrication holes (size dependent), factory greased
		
With flanges, with an inner ring, not sealed	NKI .. TN $d = 5 - 55$ mm NKI $d = 9 - 100$ mm NKIS $d = 15 - 65$ mm NA 49 $d = 10 - 140$ mm NA 69 $d = 12 - 95$ mm NA 48 $d = 110 - 380$ mm	Integral flanges, annular groove and one or more lubrication holes (size dependent) If $d \leq 7$ mm: with integral closure rings, without lubrication hole or annular groove NA 69 series bearings with an outside diameter $D \geq 52$ mm are designed as double row bearings
		
With flanges, with an inner ring, sealed on one side	NA 49.. RS $d = 10 - 50$ mm	Integral flanges, annular groove and one or more lubrication holes (size dependent), factory greased
		
With flanges, with an inner ring, sealed on both sides	NA 49...2RS $d = 10 - 50$ mm	Integral flanges, annular groove and one or more lubrication holes (size dependent), factory greased
		

Bearing types

Bearing design

Needle roller bearings with machined rings

Designation series

Inside/bore diameter range

Characteristics

Without flanges, without an inner ring, not sealed

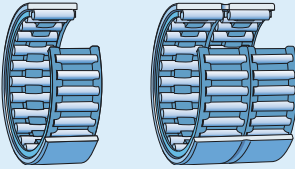

RNAO .. TN

$F_w = 5 - 12 \text{ mm}$

RNAO

$F_w = 15 - 100 \text{ mm}$

Available as single or double row bearings (→ product tables)
Double row bearings have an annular groove and a lubrication hole

Without flanges, with an inner ring, not sealed

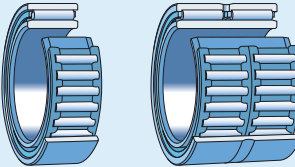

NAO .. TN

$d = 6 - 9 \text{ mm}$

NAO

$d = 12 - 90 \text{ mm}$

Available as single or double row bearings (→ product table)
Double row bearings have an annular groove and a lubrication hole
Some bearings have one lubrication hole in the inner ring (→ product table)

Alignment needle roller bearings

See chapter 5 starting on **page 141**

Bearing design

Alignment needle roller bearings

Designation series

Inside/bore diameter range

Characteristics

Without an inner ring



RPNA

$F_w = 15 - 45 \text{ mm}$

Can compensate static misalignment up to 3° between the shaft and housing
Steel cage, not sealed, no lubrication holes

With an inner ring



PNA

$d = 12 - 40 \text{ mm}$

Can compensate static misalignment up to 3° between the shaft and housing
Steel cage, not sealed, no lubrication holes

Needle roller thrust bearings

See chapter 6 starting on **page 151**

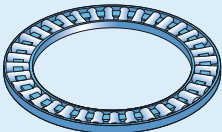
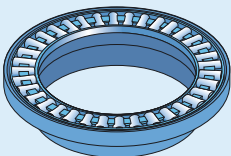
Bearing design Needle roller thrust bearings	Designation series Bore diameter range	Characteristics
<p>Needle roller and cage thrust assemblies</p> 	<p>AXK .. TN d = 4 – 8 mm</p> <p>AXK d = 10 – 160 mm</p>	<p>Appropriate washers: LS, AS, GS 811 and WS 811 series</p>
<p>Needle roller thrust bearings with a centring spigot</p> 	<p>AXW d = 10 – 50 mm</p>	<p>Can be combined with radial needle roller bearings to accommodate combined radial and axial loads</p>

Bearing washers

See chapter 6 on **page 154**

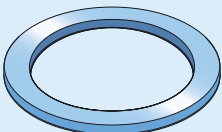
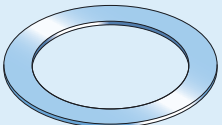
Bearing design Bearing washers	Designation series Bore diameter range	Characteristics
<p>Raceway washers, LS series</p> 	<p>LS d = 6 – 160 mm</p>	<p>Ground raceway, turned bore and outside diameter, can be combined with AXK and AXW series</p>
<p>Thrust washers, AS series</p> 	<p>AS d = 4 – 160 mm</p>	<p>Made of spring steel, 1 mm thick, hardened and polished, can be combined with AXK and AXW series, both sides can be used as raceways</p>

Bearing types

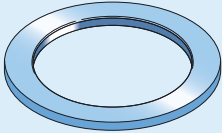
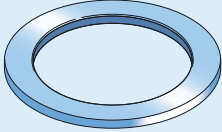
Bearing design Bearing washers	Designation series Bore/outside diameter range	Characteristics
Shaft washers, WS 811 series 	WS 811 d = 15 – 630 mm	Precision machined raceway, ground bore, can be combined with AXK and AXW series, for bore diameters up to 160 mm
Housing washers, GS 811 series 	GS 811 D = 28 – 750 mm	Precision machined raceway, ground outside diameter, can be combined with AXK series, for outside diameters up to 200 mm

Combined needle roller bearings

See chapter 7 starting on **page 169**

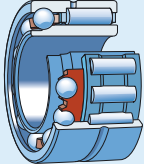
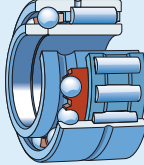
Bearing design Combined needle roller bearings	Designation series Bore diameter range	Characteristics
Needle roller / angular contact ball bearings, NKIA series 	NKIA d = 12 – 70 mm	Can accommodate axial loads in one direction
Needle roller / angular contact ball bearings, NKIB series 	NKIB d = 12 – 70 mm	Can accommodate axial loads in both directions

Bearing design
Combined needle roller bearings

Designation series
Inside diameter range

Characteristics

Needle roller / thrust ball bearings, NX series

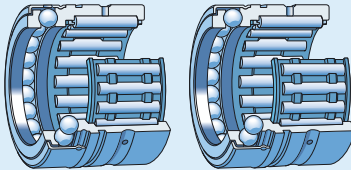

NX series

NX..Z series

NX .. (Z)TN
 $F_w = 7 \text{ mm}$

NX .. (Z)
 $F_w = 10 - 35 \text{ mm}$

Full complement thrust ball bearing, steel cover with or without lubrication holes
NX .. Z series: factory greased thrust bearing, steel cover without lubrication hole

Needle roller / thrust ball bearings, NKX series

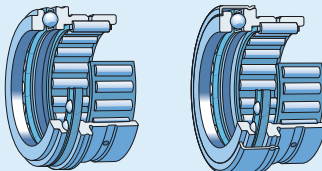

NKX series

NKX..Z series

NKX .. (Z)TN
 $F_w = 10 \text{ mm}$

NKX .. (Z)
 $F_w = 12 - 70 \text{ mm}$

Thrust ball bearing with a cage, with or without steel cover
NKX .. Z series: factory greased thrust bearing, steel cover without lubrication hole

Needle roller / cylindrical roller thrust bearings, NKXR series

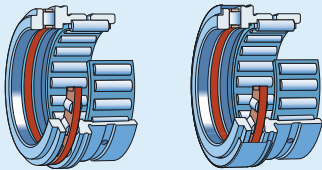

NKXR series

NKXR..Z series

NKXR
 $F_w = 15 - 50 \text{ mm}$

NKXR .. Z
 $F_w = 15 - 50 \text{ mm}$

Separable bearing design

Thrust bearing with a steel cover and initial grease fill, non-separable bearing design

Bearing types

Needle roller bearing inner rings

See chapter 8 starting on **page 195**

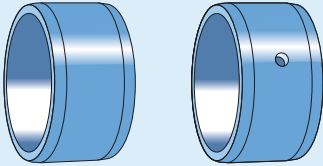
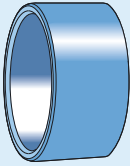
Bearing design Needle roller bearing inner rings	Designation series Bore diameter range	Characteristics
 <p data-bbox="157 480 221 499">IR series</p> <p data-bbox="344 480 445 499">IR.. IS1 series</p>	<p data-bbox="575 304 594 323">IR</p> <p data-bbox="575 323 687 343">d = 5 – 380 mm</p> <p data-bbox="575 357 636 376">IR .. IS1</p> <p data-bbox="575 376 678 395">d = 6 – 50 mm</p>	<p data-bbox="815 304 997 427">Made of carbon chromium bearing steel, hardened, precision machined raceway with a lead-in chamfer on both sides, with or without lubrication hole(s)</p>
 <p data-bbox="157 730 225 746">LR series</p>	<p data-bbox="575 555 598 574">LR</p> <p data-bbox="575 574 678 592">d = 7 – 50 mm</p>	<p data-bbox="815 555 997 624">Made of carbon chromium bearing steel, hardened, ground bore and raceway, turned side faces</p>

Radial shaft seals with a low cross sectional height

See chapter 8 on **page 208**

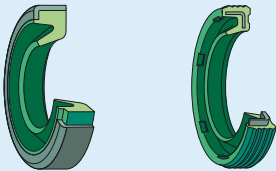
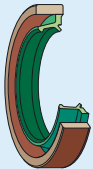
Bearing design Radial shaft seals with a low cross sectional height	Designation series Bore diameter range	Characteristics
 <p data-bbox="157 1209 241 1225">G .. S series</p> <p data-bbox="344 1209 400 1225">G series</p>	<p data-bbox="575 1098 617 1117">G .. S</p> <p data-bbox="575 1117 678 1136">d₁ = 4 – 7 mm</p> <p data-bbox="575 1150 586 1169">G</p> <p data-bbox="575 1169 687 1189">d₁ = 8 – 70 mm</p>	<p data-bbox="815 1029 997 1082">Single lip design, made of acrylonitrile-butadiene rubber</p> <p data-bbox="815 1098 975 1134">Rubber material metal cased</p> <p data-bbox="815 1150 969 1173">Sheet steel reinforced</p>
 <p data-bbox="157 1461 230 1477">SD design</p>	<p data-bbox="575 1281 598 1300">SD</p> <p data-bbox="575 1300 687 1318">d₁ = 8 – 50 mm</p>	<p data-bbox="815 1281 997 1350">Double lip design, lips are made of polyurethane elastomer, polyamide reinforcement ring</p>

Track runner bearings

SKF track runner bearings are rolling bearings with a very thick-walled outer ring that can accommodate heavy loads as well as shock loads. The designs of track runner bearings are based on ball bearings, needle roller bearings as well as cylindrical roller bearings.

SKF supplies track runner bearings in many different designs and for a wide variety of operating conditions and applications. They are ready-to-mount pre-greased units and are intended for all types of cam drives, tracks, conveyor systems, etc. The rails used for SKF linear guides can serve as tracks for the bearings.

Basics of the SKF track runner bearing assortment are listed below and comprises the following types:

- cam rollers
- support rollers
- cam followers

Cam rollers

Not covered in this catalogue.

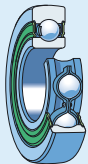
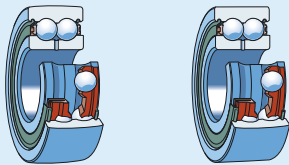

For additional information, refer to the *SKF Interactive Engineering Catalogue*.

Bearing design Cam rollers	Designation series Outside diameter range	Characteristics
<p>Single row</p> 	<p>3612.. R D = 32 – 80 mm</p>	<p>Sealed, crowned running surface</p>
<p>Double row</p> 	<p>3058.. C-2Z D = 32 – 80 mm</p> <p>3057.. C-2Z D = 35 – 80 mm</p>	<p>Sealed</p> <p>Crowned running surface</p> <p>Cylindrical running surface</p>
<p>3058.. C-2Z series</p>	<p>3057.. C-2Z series</p>	

Bearing types

Support rollers

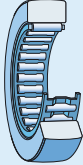
See chapter 9 starting on **page 215**

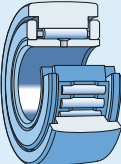
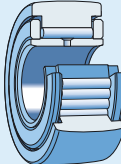
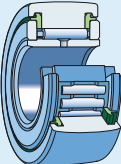
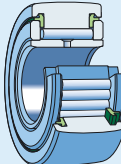
Bearing design Support rollers	Designation series Outside diameter range	Characteristics	
Without flange rings, (R)STO and (R)NA 22...2RS designs			
		STO .. TN D = 19 – 24 mm	Crowned running surface
STO design	RSTO design	STO D = 30 – 90 mm	
		RSTO .. TN D = 16 – 24 mm	
NA 22...2RS design	RNA 22...2RS design	RSTO D = 30 – 90 mm	
NA 22...2RS D = 19 – 90 mm			
RNA 22...2RS D = 19 – 80 mm			
With flange rings, NATR and NATV designs			
		NATR NATV D = 16 – 62 mm	Crowned running surface
NATR design	NATV design		
		NATR .. PPA NATV .. PPA D = 16 – 90 mm	Improved crowned running surface
NATR .. PPA series	NATV .. PPA series		

Bearing design
Support rollers

Designation series
Outside diameter range

Characteristics

With flange rings, NUTR .. A design

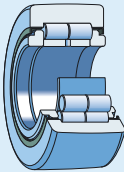

NUTR .. A
D = 35 – 110 mm

Can accommodate axial forces and heavy shock loads, improved crowned running surface

With flange rings, PWTR ...2RS design

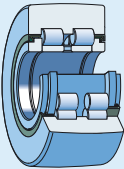

PWTR ...2RS
D = 35 – 110 mm

Improved crowned running surface

With flange rings, NNTR ...2ZL design

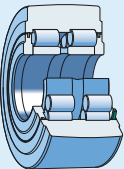

NNTR ...2ZL
D = 130 – 310 mm

Size-dependent crowned running surface

Bearing types

Cam followers

See chapter 9 on page 238

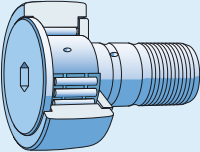
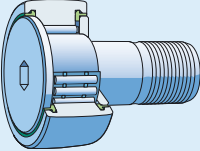
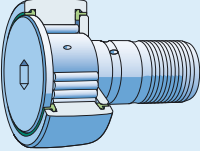
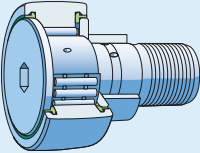
Bearing design Cam followers	Designation series Outside diameter range	Characteristics
KR design		
	KR .. B D = 22 – 40 mm	Crowned outer ring running surface as standard, designation suffixes PPSKA and PPA with an improved crowned profile, with or without axial sliding rings, cage-guided or full complement of needle rollers, concentric or eccentric seat, size-dependent characteristics regarding relubrication and holding during mounting
KR .. B series	KR .. (PPSKA) D = 16 – 19 mm	
	KR .. PPA KRV .. PPA KRE .. PPA D = 16 – 90 mm	
KR .. PPSKA series		
		
KRV .. PPA series		
		
KRE .. PPA series		

Bearing design
Cam followers

Designation series
Outside diameter range

Characteristics

NUKR design

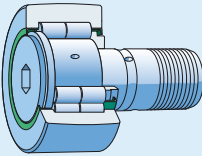

NUKR .. A design

NUKR .. A
NUKRE .. A
D = 35 – 90 mm

Improved crowned profile of the outer ring running surface, concentric seat or eccentric collar on the stud

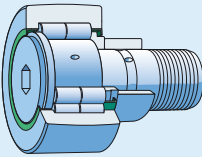

NUKRE .. A design

PWKR design

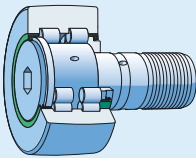

PWKR ...2RS design

PWKR ...2RS
PWKRE ...2RS
D = 35 – 90 mm

Improved crowned profile of the outer ring running surface, concentric seat or eccentric collar on the stud

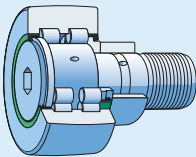

PWKRE ...2RS design

Bearing life and loads

Bearing life

The bearing size to be used can be selected on the basis of its load ratings in relation to the applied loads and the requirements regarding bearing life and reliability. A simple way to calculate bearing life is the classic ISO formula for basic rating life. However, SKF recommends using the SKF rating life, which makes predicting bearing life more reliable.

The values of the basic dynamic load rating C and the basic static load rating C_0 are listed in the product tables.

For additional information about the calculation methods and the equations, refer to the *SKF General Catalogue*. Calculations can also be performed easily online using the *SKF Interactive Engineering Catalogue*, available online at www.skf.com.

The general information about bearing life calculations and basic load ratings provided in the *SKF General Catalogue* and in the *SKF Interactive Engineering Catalogue* are also valid for needle roller bearings.

Equivalent bearing loads

Needle roller bearings can accommodate either radial loads (radial bearings) or axial loads (thrust bearings). Therefore, the equivalent bearing load P is equal to the calculated bearing load F and can be inserted directly into the life equations.

Combined needle roller bearings

The equation $P = F$ is also valid for the radial and thrust bearing of combined needle roller bearings. It is necessary to calculate the life of the

radial needle roller bearing and the thrust bearing separately.

For needle roller / angular contact ball bearings, the axial component of the load F_a must not exceed 25% of the radial component of the load F_r .

The values of the basic load ratings C for the radial and axial bearings are listed separately in the product tables.

Static bearing loads

The basic static load rating C_0 is used in calculations when the bearings are to:

- rotate at very slow speeds ($n < 10$ r/min)
- perform very slow oscillating movements
- be stationary under load for extended periods
- be under shock or heavy peak loads, whether it is rotating (dynamically stressed) or at rest

If one of these conditions exists, refer to the *SKF General Catalogue* (section *Selection of bearing size*).

Requisite minimum load

The correlation between load and service life is less important when bearings are subjected to very light loads, because the failure mode is typically something other than fatigue.

To achieve satisfactory operation, needle roller and track runner bearings must always be subjected to a requisite minimum load. Applying a requisite minimum load is especially important for bearings that operate at high speeds or are subjected to high accelerations or rapid changes in the direction of load. Under these conditions, not applying the correct minimum load can

result in damaging sliding movement between the rollers and raceways caused by the inertia forces of the needle rollers and cage and friction in the lubricant.

The requisite minimum radial and axial loads to be applied can be estimated for:

- radial needle roller bearings using

$$F_{rm} = 0,02 C$$

- needle roller thrust bearings using

$$F_{am} = 0,0005 C_0$$

- track runner bearings using

$$F_{rm} = 0,0167 C_0$$

The requisite minimum axial load for the thrust part of combined bearings can be obtained for:

- angular contact ball bearings using

$$F_{am} = 0,25 \frac{C_0}{1\,000} \left(\frac{n d_m}{100\,000} \right)^2$$

- cylindrical roller thrust bearings using

$$F_{am} = 0,0005 C_0 + A \left(\frac{n}{1\,000} \right)^2$$

- thrust ball bearings using

$$F_{am} = A \left(\frac{n}{1\,000} \right)^2$$

where

F_{rm} = minimum radial load [kN]

F_{am} = minimum axial load [kN]

C = basic dynamic load rating
(→ product tables) [kN]

C_0 = basic static load rating
(→ product tables) [kN]

d_m = mean bearing diameter
= $0,5 (d + D)$ [mm]

n = rotational speed [r/min]

A = minimum load factor (→ product tables)

When starting up at low temperatures or when the lubricant is highly viscous, an even greater minimum load may be required. However, the weight of the components supported by the bearing, together with the external forces, generally exceeds the requisite minimum load. If this is not the case, the bearing must be subjected to an additional radial and/or axial load.

Friction

Friction in a bearing can be described as the resistance to rotation. The friction dictates the amount of heat generated within a bearing and consequently determines the bearing operating temperature. The amount of friction within a bearing depends on the load and several other factors including bearing type, size, operating speed, and the properties and quantity of the lubricant.

Friction in a bearing is produced in the contact areas. These are the areas where the rolling elements make contact with the raceways, cage(s), guiding surfaces and lubricant. If the bearing is sealed, the contact area also includes the area where the sealing lip makes contact with its counterface.

Estimating the frictional moment

The frictional moment can be calculated with sufficient accuracy under the following conditions:

- bearing load $P \approx 0,1 C$
- good lubrication
- normal operating conditions

When using a coefficient of friction, the equations to be used are the following:

for radial needle roller bearings

$$M = 0,5 \mu P F_w$$

and for other bearing types

$$M = 0,5 \mu P d$$

Table 1

Coefficient of friction μ for bearings without seals, with a cage

Bearing type	Coefficient
Radial needle roller bearings	0,0022
Needle roller thrust bearings	0,0050
Thrust part of combined bearings	
Angular contact ball bearings	0,0020
Thrust ball bearings	0,0013
Cylindrical roller thrust bearings	0,0050

where

M = frictional moment [Nmm]

μ = coefficient of friction (\rightarrow table 1)

P = equivalent dynamic bearing load [N]

F_w = diameter under rollers [mm]

For needle roller bearings with an inner ring, the inner ring raceway diameter F is to be used.

d = bearing bore diameter [mm]

For additional information about calculating the frictional moment of needle roller bearings, refer to the SKF *General Catalogue*. Calculations can be easily performed online using the *SKF Interactive Engineering Catalogue*, available online at www.skf.com.

For information about calculating the frictional moment of track runner bearings, contact the SKF application engineering service.

Speeds

In the product tables, two speeds are typically listed: reference speed and limiting speed.

The reference speed represents the speed, under specific operating conditions, at which there is equilibrium between the heat that is generated by the bearing and the heat that is dissipated from the bearing via the shaft, housing and lubricant.

Limiting speed is determined by criteria that include the form stability or strength of the cage, lubrication of cage guiding surfaces, centrifugal and gyratory forces acting on the rolling elements, precision and other speed-limiting factors such as seals and lubricant for sealed bearings.

Which of these two speed values to consider depends on the needs of the application. In certain applications, such as very low speeds or oscillating movements, the speed limits are superseded in importance by other considerations.

For certain bearings, where the speed limit is not determined by heat from the rolling elements/raceway contacts, only limiting speeds are listed in the product tables. These include, for example, bearings with contact seals and all track runner bearings.

For additional information about speeds and calculations, refer to the SKF *General Catalogue* (section *Speeds and vibration*).

Bearing data – general

SKF needle roller bearings are manufactured to several specifications. These specifications, concerning tolerances and internal clearance, are described in the following sections. Information about each bearing type is provided in the introductory text of the individual product chapters.

Tolerances

Unless otherwise stated, the needle roller bearings listed in this catalogue are manufactured to dimensional, form and running accuracy of needle roller bearings in accordance with the following international standards:

- ISO 199:2005: Rolling bearings – Thrust bearings – Tolerances
- ISO 492:2002: Rolling bearings – Radial bearings – Tolerances

Information about the bearing types and the relevant tolerance classes are provided in the introductory text of the individual product chapters as well as tolerances for the inside diameter F_w of the roller set. Actual tolerance values are listed in **tables 2 to 5** on **pages 38 to 41**. The tolerance symbols used there are listed together with their definitions in **table 1**.

Table 1

1

Tolerance symbols

Symbol	Definition
Bore diameter	
d	Nominal bore diameter
d_{mp}	Mean bore diameter, arithmetical mean of the largest and smallest single bore diameters in one plane
Δ_{dmp}	Deviation of the mean bore diameter from the nominal ($\Delta_{dmp} = d_{mp} - d$)
V_{dp}	Bore diameter variation; difference between the largest and smallest single bore diameters in one plane
V_{dmp}	Mean bore diameter variation; difference between the largest and smallest mean bore diameter
Outside diameter	
D	Nominal outside diameter
D_{mp}	Mean outside diameter; arithmetical mean of the largest and smallest single outside diameters in one plane
Δ_{Dmp}	Deviation of the mean outside diameter from the nominal ($\Delta_{Dmp} = D_{mp} - D$)
V_{Dp}	Outside diameter variation; difference between the largest and smallest single outside diameters in one plane
V_{Dmp}	Mean outside diameter variation; difference between the largest and smallest mean outside diameters of one ring or washer
Width or height	
B_s, C_s	Single width of the inner ring and outer ring, respectively
$\Delta_{B_s}, \Delta_{C_s}$	Deviation of the single inner ring width or single outer ring width from the nominal ($\Delta_{B_s} = B_s - B$; $\Delta_{C_s} = C_s - C$)
V_{B_s}, V_{C_s}	Ring width variation; difference between the largest and smallest single widths of the inner ring and of the outer ring, respectively
T_s	Single height (H) of a single direction thrust bearing
Δ_{T_s}	Deviation of the single height of a thrust bearing from the nominal ($\Delta_{T_s} = T_s - T$)
Running accuracy	
K_{ia}, K_{ea}	Radial runout of the inner ring and outer ring, respectively, of an assembled bearing
S_d	Side face runout with reference to the bore (of an inner ring)
S_D	Outside inclination variation; variation in inclination of an outside cylindrical surface to an outer ring side face
S_i, S_e	Thickness variation, measured from the middle of the raceway to the back (seat) face of the shaft washer and of the housing washer, respectively (axial runout)

Table 2

Normal tolerances for radial needle roller bearings and track runner bearings

Inner ring

d ¹⁾ over	incl.	Δ_{dmp}		V_{dp} max	V_{dmp} max	Δ_{Bs}		V_{Bs} max	K_{ia} max
		high	low			high	low		
mm		μm		μm	μm	μm		μm	μm
2,5	10	0	-8	10	6	0	-120	15	10
10	18	0	-8	10	6	0	-120	20	10
18	30	0	-10	13	8	0	-120	20	13
30	50	0	-12	15	9	0	-120	20	15
50	80	0	-15	19	11	0	-150	25	20
80	120	0	-20	25	15	0	-200	25	25
120	180	0	-25	31	19	0	-250	30	30
180	250	0	-30	38	23	0	-300	30	40
250	315	0	-35	44	26	0	-350	35	50
315	400	0	-40	50	30	0	-400	40	60

¹⁾ For cam followers the stud shank diameter d can be used as the bore diameter reference.

Outer ring

D over	incl.	Δ_{Dmp}		V_{Dp} max	V_{Dmp} max	Δ_{Cs}, V_{Cs}	K_{ea} max
		high	low				
mm		μm		μm	μm		μm
6	18	0	-8	10	6	Values are identical to those for inner ring of same bearing (Δ_{Bs}, V_{Bs})	15
18	30	0	-9	12	7		15
30	50	0	-11	14	8		20
50	80	0	-13	16	10		25
80	120	0	-15	19	11		35
120	150	0	-18	23	14		40
150	180	0	-25	31	19		45
180	250	0	-30	38	23		50
250	315	0	-35	44	26		60
315	400	0	-40	50	30		70
400	500	0	-45	56	34		80

Table 3

1

Class P6 tolerances for radial bearings

Inner ring

d over	incl.	Δ_{dmp} high low		V_{dp} max	V_{dmp} max	Δ_{Bs} high low		V_{Bs} max	K_{ia} max
mm		μm		μm	μm	μm		μm	μm
2,5	10	0	-7	9	5	0	-120	15	6
10	18	0	-7	9	5	0	-120	20	7
18	30	0	-8	10	6	0	-120	20	8
30	50	0	-10	13	8	0	-120	20	10
50	80	0	-12	15	9	0	-150	25	10
80	120	0	-15	19	11	0	-200	25	13
120	180	0	-18	23	14	0	-250	30	18
180	250	0	-22	28	17	0	-300	30	20
250	315	0	-25	31	19	0	-350	35	25
315	400	0	-30	38	23	0	-400	40	30

Outer ring

D over	incl.	Δ_{Dmp} high low		V_{Dp} max	V_{Dmp} max	Δ_{Cs}, V_{Cs}	K_{ea} max
mm		μm		μm	μm		μm
6	18	0	-7	9	5	Values are identical to those for inner ring of same bearing (Δ_{Bs}, V_{Bs})	8
18	30	0	-8	10	6		9
30	50	0	-9	11	7		10
50	80	0	-11	14	8		13
80	120	0	-13	16	10		18
120	150	0	-15	19	11		20
150	180	0	-18	23	14		23
180	250	0	-20	25	15		25
250	315	0	-25	31	19		30
315	400	0	-28	35	21		35
400	500	0	-33	41	25		40

Table 4

Class P5 tolerances for radial bearings

Inner ring

d over	incl.	Δ_{dmp}		V_{dp}	V_{dmp}	Δ_{Bs}		V_{Bs}	K_{ia}	S_d
		high	low	max	max	high	low	max	max	max
mm		μm		μm	μm	μm		μm	μm	μm
2,5	10	0	-5	5	3	0	-40	5	4	7
10	18	0	-5	5	3	0	-80	5	4	7
18	30	0	-6	6	3	0	-120	5	4	8
30	50	0	-8	8	4	0	-120	5	5	8
50	80	0	-9	9	5	0	-150	6	5	8
80	120	0	-10	10	5	0	-200	7	6	9
120	180	0	-13	13	7	0	-250	8	8	10
180	250	0	-15	15	8	0	-300	10	10	11
250	315	0	-18	18	9	0	-350	13	13	13
315	400	0	-23	23	12	0	-400	15	15	15

Outer ring

D over	incl.	Δ_{Dmp}		V_{Dp}	V_{Dmp}	Δ_{Cs}	V_{Cs}	K_{ea}	S_D
		high	low	max	max		max	max	max
mm		μm		μm	μm		μm	μm	μm
6	18	0	-5	5	3	Values are identical to those for inner ring of same bearing (Δ_{Bs}, V_{Bs})	5	5	8
18	30	0	-6	6	3		5	6	8
30	50	0	-7	7	4		5	7	8
50	80	0	-9	9	5		6	8	8
80	120	0	-10	10	5		8	10	9
120	150	0	-11	11	6		8	11	10
150	180	0	-13	13	7		8	13	10
180	250	0	-15	15	8		10	15	11
250	315	0	-18	18	9		11	18	13
315	400	0	-20	20	10		13	20	13
400	500	0	-23	23	12		15	23	15

Table 6

Chamfer dimension limits

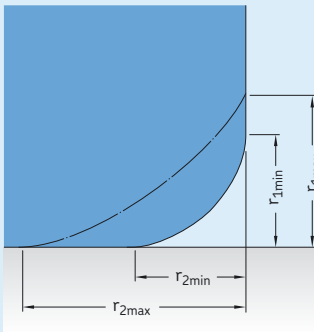

Minimum value $r_{s \text{ min}}$	Nominal bearing bore diameter		Maximum values		
	over	incl.	Radial bearings $r_{1 \text{ max}}$	Thrust bearings $r_{2 \text{ max}}$	$r_{1,2 \text{ max}}$
mm	mm	mm	mm	mm	mm
0,1	–	–	0,2	0,4	0,2
0,15	–	–	0,3	0,6	0,3
0,2	–	–	0,5	0,8	0,5
0,3	–	40	0,6	1	0,8
	40	–	0,8	1	0,8
0,6	–	40	1	2	1,5
	40	–	1,3	2	1,5
1	–	50	1,5	3	2,2
	50	–	1,9	3	2,2
1,1	–	120	2	3,5	2,7
	120	–	2,5	4	2,7
1,5	–	120	2,3	4	3,5
	120	–	3	5	3,5
2	–	80	3	4,5	4
	80	220	3,5	5	4
	220	–	3,8	6	4
2,1	–	280	4	6,5	4,5
	280	–	4,5	7	4,5

Limits for chamfer dimensions

Minimum values for the chamfer dimensions are listed in the product tables. To prevent the improper dimensioning of fillets on associated components for needle roller bearings and to facilitate the calculation of snap ring location arrangements, the maximum chamfer limits for the relevant minimum value of chamfer dimensions are listed in **table 6**. These limits are in accordance with ISO 582:1995. The symbols used are explained below:

- d nominal bearing bore diameter
- r_1 maximum value in the radial direction
- r_2 maximum value in the axial direction
- $r_{s \text{ min}}$ general symbol for the minimum value of chamfer dimensions

Table 5

Normal tolerance class for washers and thrust bearings

Shaft washer, WS

d	Δ_{dmp}		V_{dp}	$S_i^{1)}$	$\Delta_{Ts}^{1)}$		
	over	incl.			high	low	high
mm	μm		μm	μm	μm	μm	
–	18	0	–8	6	10	+20	–250
18	30	0	–10	8	10	+20	–250
30	50	0	–12	9	10	+20	–250
50	80	0	–15	11	10	+20	–250
80	120	0	–20	15	15	+25	–300
120	180	0	–25	19	15	+25	–300

Housing washer, GS

d	Δ_{dmp}		V_{Dp}	S_e	
	over	incl.			high
mm	μm		μm	μm	
18	30	0	–13	10	10
30	50	0	–16	12	10
50	80	0	–19	14	10
80	120	0	–19	14	10
120	180	0	–25	19	15
180	250	0	–30	23	20

¹⁾ Also valid where raceway washers in the LS series are used

Internal clearance

Bearing internal clearance is defined as the total distance through which one bearing ring can be moved relative to the other in the radial direction (radial internal clearance) or in the axial direction (axial internal clearance).

It is necessary to distinguish between the internal clearance in a bearing before mounting and the internal clearance in a mounted bearing that has reached its operating temperature (operational clearance). The initial internal clearance (before mounting) is greater than the operational clearance because the degree of the interference fits and the effects of thermal expansion of the bearing rings and associated components will expand or compress the rings.

Bearing internal clearance referred to as Normal has been selected so that a suitable operational clearance will be obtained when the bearing is mounted with the recommended fits and operating under normal conditions. In applications where conditions are not normal,

e.g. where interference fits are used for both bearing rings, unusual temperatures prevail, or bearings with greater or smaller internal clearance than Normal are required, SKF recommends checking residual clearance in the bearing after it has been mounted.

Unless otherwise stated, SKF needle roller bearings with an inner ring have Normal radial internal clearance. Bearings having an internal clearance other than Normal are identified by the designation suffix C2, C3 or C4. The clearance values (→ **table 7**) are in accordance with ISO 5753:1991 and are valid for unmounted bearings under zero measuring load.

Table 7

Radial internal clearance for needle roller bearings and track runner bearings

Bore diameter d ¹⁾		Radial internal clearance C2		Normal		C3		C4	
over	incl.	min	max	min	max	min	max	min	max
mm		µm							
–	30	0	25	20	45	35	60	50	75
30	40	5	30	25	50	45	70	60	85
40	50	5	35	30	60	50	80	70	100
50	65	10	40	40	70	60	90	80	110
65	80	10	45	40	75	65	100	90	125
80	100	15	50	50	85	75	110	105	140
100	120	15	55	50	90	85	125	125	165
120	140	15	60	60	105	100	145	145	190
140	160	20	70	70	120	115	165	165	215
160	180	25	75	75	125	120	170	170	220
180	200	35	90	90	145	140	195	195	250
200	225	45	105	105	165	160	220	220	280
225	250	45	110	110	175	170	235	235	300
250	280	55	125	125	195	190	260	260	330
280	315	55	130	130	205	200	275	275	350
315	355	65	145	145	225	225	305	305	385
355	400	100	190	190	280	280	370	370	460

¹⁾ For cam followers, the stud shank diameter d can be used as the bore diameter reference.

Cages

Bearing cages can influence the suitability of a rolling bearing for a particular application. Their main purposes are:

- to separate the rolling elements and keep them spaced evenly for uniform load distribution
- to reduce noise levels
- to guide the rolling elements in the unloaded zone to improve rolling conditions and prevent damaging sliding movements
- to retain the rolling elements when mounting separable bearings

Cages are stressed by friction, inertia forces and heat. Depending on the material, cages can also be affected by certain lubricants, lubricant additives, organic solvents, coolants, or by-products of these substances as they age. Therefore, cage design and material are of paramount importance for the performance and the operational reliability of the bearing.

For larger bearings, the standard cage may be different than the one used in smaller bearings even though they are in the same design or series. In the introductory text of each product chapter, information is provided about standard cages.

Seals

The seals integrated in a needle roller bearing can have a considerable impact on the performance and reliability of the bearing. Their primary purpose is to exclude solid contaminants and moisture and retain the lubricant in the bearing. The seal materials must withstand oxidation and offer excellent thermal or chemical resistance. Integral seals are generally contact seals or sliding rings.

Depending on the internal geometry and design of the bearing, the arrangement of the bearing and associated components can form non-contact seals and act as efficient labyrinth or gap-type seals.

Additional information about seals is available in the introductory text of each product chapter, if seals are available.

In addition to integral bearing seals, SKF also supplies an assortment of radial shaft seals that can be used as external seals. Appropriate seals are listed in the product tables, if available. For

additional information, refer to the section *Radial shaft seals with a low cross sectional height*, starting on **page 208**.

Materials

The material used to make a bearing component determines, to a large extent, the performance and reliability of that bearing. For the bearing rings and rolling elements, typical considerations include hardness for load carrying capacity, fatigue resistance under rolling contact conditions, under clean or contaminated lubrication conditions, and the dimensional stability of the bearing components.

For additional information about seal materials, refer to the *SKF General Catalogue*. The general information about materials also applies to needle roller bearings.

Materials for bearing rings and rolling elements

The standard steel used to produce machined rings and rolling elements of SKF needle roller bearings is a carbon chromium steel for through-hardening, containing approximately 1% carbon and 1,5% chromium, in accordance with ISO 683:17:1999.

Unless otherwise stated in the product chapters, bearing washers are also made of this carbon chromium bearing steel.

The thin-walled deep drawn outer rings of drawn cup needle roller bearings and the drawn sheet steel sleeve of alignment needle roller bearings are exceptions. They are made of mild steel in accordance with EN 10139:1997.

The majority of outer rings of track runner bearings are made of bearing steels for case-hardening because of their ability to withstand heavy shock loads. Materials that can be used are chromium-nickel and manganese-chromium alloyed steel in accordance with ISO 683-17:1999.

Standard needle roller bearings and track runner bearings made of carbon chromium steel or steel for case hardening are heat stabilized up to 120 °C unless otherwise stated in the introductory text of the product chapter. Bearings used in applications where temperatures exceed 120 °C must be subjected to a special heat stabilization process to provide adequate dimensional stability.

Cage materials

Polyamide 66

Polyamide 66, with glass fibre reinforcement, is used for cages in many needle roller bearings and thrust bearings. Polyamide 66 is characterized by a favourable combination of strength and elasticity.

Due to its excellent sliding properties on lubricated steel surfaces and the superior finish of the contact surfaces, polyamide 66 cages promote low friction, low heat generation and low wear.

Polyamide 66 can be used for operating temperatures ranging from -40 to $+120$ °C, provided it does not come in contact with aggressive lubricants. Aggressive lubricants (e.g. oils with EP additives or some synthetic oils) promote ageing effects that can be compensated for by reducing the normal operating temperature. At temperatures below -40 °C, polyamide loses its elasticity, which can result in cage failures. For additional information about the cage material, particularly the relationship between the operating temperatures and the cage ageing life, refer to the SKF *General Catalogue*.

Steel cages

Steel cages can be used at operating temperatures up to 300 °C. They are not affected either by mineral or synthetic oil-based lubricants or by the organic solvents used to clean a bearing. They are designed as window-type cage.

Sheet steel cages are pressed from continuously hot-rolled low carbon steel. These lightweight cages have relatively high strength and can be surface treated to further reduce friction and wear.

Machined steel cages are made of non-alloyed structural steel. To improve sliding and wear-resistance, some machined steel cages are surface treated.

Seal materials

Acrylonitrile-butadiene rubber (NBR)

Acrylonitrile-butadiene rubber (NBR) is the "universal" seal material. This copolymer, produced from acrylonitrile and butadiene, shows good resistance to the following media:

- most mineral oils and greases with a mineral oil base
- normal fuels: petrol, diesel and light heating oils
- animal and vegetable oils and fats
- hot water

NBR also tolerates short-term dry running of the sealing lip. The permissible operating temperature range is -40 to $+100$ °C. For brief periods, temperatures of up to 120 °C can be tolerated. At higher temperatures, the material hardens.

Polyurethane

Polyurethane (AU) is a wear-resistant organic material with good elastic properties. It is resistant to mineral oil based greases and lubricating oils, even those containing small quantities of EP (Extreme Pressure) additives. The permissible operating temperature range is -30 to $+100$ °C.

Fluoro rubber

Fluoro rubbers (FKM) are characterized by their high thermal and chemical resistance. Their resistance to ageing and ozone is very good and their gas permeability is very slight. They have exceptionally good wear characteristics even under harsh environmental conditions and can withstand operating temperatures up to 200 °C. Seals made from this material can tolerate dry running of the lip for short periods.

Fluoro rubbers are also resistant to oils and hydraulic fluids, fuels and lubricants, mineral acids and aliphatic, as well as aromatic hydrocarbons, which would cause seals made from other materials to fail. In the presence of esters, ethers, ketones, certain amines and hot anhydrous hydrofluorides, fluoro rubbers should not be used.

Note

At temperatures above 300 °C, fluoro rubber gives off dangerous fumes. As handling seals made of fluoro rubber constitutes a potential safety risk, the safety precautions mentioned hereafter must always be followed.

WARNING!**Safety precautions for fluoro rubber**

Fluoro rubber is very stable under normal operating conditions up to 200 °C. At temperatures above 200 °C, the material hardens and loses its effectiveness.

At temperatures above 300 °C, which is usually the result of a fire or the flame of a cutting torch, fluoro rubber seals will give off hazardous fumes which can be harmful to the eyes and, if inhaled, to the respiratory system.

Once fluoro rubber has been heated to 300 °C or above, it is dangerous to handle, **even after it has cooled.** Therefore, the following safety precautions should be observed when handling such material:

- Always wear protective goggles, gloves and appropriate breathing apparatus.
- Place the remains of the seals in an airtight plastic container marked with a symbol for “material will etch”.
- Follow the safety precautions in the appropriate material safety data sheet (MSDS).

Anyone who contacts these seals or their remains should wash their hands with soap and plenty of water and flush eyes with plenty of water and consult a doctor immediately. If the fumes have been inhaled, they should consult a doctor immediately.

The user is responsible for the correct use of the product during its service life and its proper disposal.

Supplementary designations

The complete designation for needle roller and track runner bearings consists of a basic designation, which identifies bearing type and size, as well as supplementary designations. These designation suffixes identify design features that differ from the standard design. Where several supplementary designations are used to identify a particular bearing, they are always written in a specific order. The supplementary designations listed below are not exhaustive, but include those most commonly used.

Suffix Description

A	NUTR design support rollers and NUKR design cam followers with an improved crowned profile of the outer ring running surface
AS..	Lubrication hole(s) in the outer ring, a figure following indicates the number of holes
ASR..	Annular groove and lubrication hole(s) in the outer ring, a figure following indicates the number of holes
B	KR design cam followers with a crowned profile of the outer ring running surface and a recessed hexagon on both ends of the stud
BF	Needle roller with flat ends
C2	Bearing internal clearance smaller than Normal
C3	Bearing internal clearance greater than Normal
CN	Bearing internal clearance Normal, only used together with an additional letter (H, L, M, P) that identifies a reduced or displaced clearance range
C4	Bearing internal clearance greater than C3
D	Deviating or modified internal design with the same boundary dimensions. Generally dropped after a certain changeover period, but may have the significance to bound to the particular bearing design/series Example: K 40×45×17 D Needle roller and cage assembly with a double split cage
DS	Single split needle roller and cage assembly

EGS	Inner ring with a non-directionally ground raceway
G2	Needle roller in accordance with ISO 3096:1996 Grade 2
H..	Needle roller bearing without an inner ring, with reduced inside diameter (under rollers) tolerance, followed by tolerance limits in μm , e.g. H+27+20
IS..	Needle roller bearing with one or more lubricating holes in the inner ring, a figure following indicates the number of holes
ISR..	Needle roller bearing with an annular groove and one or more lubricating holes in the inner ring, a figure following indicates the number of holes
M../M..	Diameter tolerance of needle rollers, e.g. M2/M4 indicates diameter tolerance -2 to $-4 \mu\text{m}$
N/M..	Diameter tolerance of needle rollers, e.g. N/M2 indicates diameter tolerance 0 to $-2 \mu\text{m}$
P5	Dimensional and running accuracies to ISO tolerance class 5
P6	Dimensional and running accuracies to ISO tolerance class 6
P6CNR	P6 + CNR
P62	P6 + C2
P63	P6 + C3
PPA	<ol style="list-style-type: none"> NATR or NATV design support rollers with a polyamide 66 axial sliding and sealing ring on both sides. Improved crowned profile of the outer ring running surface. KR design cam followers have the same features as listed above. Sizes 16 and 19 have one slot in the head of the stud as standard. Size 22 and larger have a recessed hexagon on both ends.
PPSKA	KR design cam followers, sizes 16 and 19, with a polyamide 66 axial sliding and sealing ring on both sides, improved crowned profile of the outer ring running surface and a hexagon recessed into the head of the stud. These cannot be relubricated.
PPXA	Cam followers with PPA features except for the outer ring running surface, which has a cylindrical profile
RS	Contact seal of acrylonitrile-butadiene rubber (NRB) with or without sheet steel reinforcement on one side of the bearing

- .2RS** RS contact seal on both sides of the bearing
- ..S** Matched bearings for an equal distribution of the radial load. The figure preceding indicates the number of bearings, e.g. NK 50/25 TN/2S
- S** Radial shaft seals with low cross sectional height, rubber material is metal cased, e.g. G 6×12×2 S
- 2S** Two matched bearings for an equal distribution of radial load (refer to S, the figure preceding the S indicates the number of bearings)
- S0** Bearing rings or washers dimensionally stabilized for use at operating temperatures up to 150 °C
- S1** Bearing rings or washers dimensionally stabilized for use at operating temperatures up to 200 °C
- S2** Bearing rings or washers dimensionally stabilized for use at operating temperatures up to 250 °C
- S3** Bearing rings or washers dimensionally stabilized for use at operating temperatures up to 300 °C
- SM..** Special grease, two figures following identify the grease
- /SORT..** Tolerance grade of needle rollers of a needle roller and cage assembly, the figures following give the actual limits in µm, e.g. /SORT-2-4
- TN** Injection moulded cage of polyamide 66 with glass fibre reinforcement
- VGS** Inner ring with a pre-ground raceway and a machining allowance
- VG052** Single split cage of polyethersulfone (PES)
- X** Track runner bearings with a cylindrical (flat) profile of the outer ring running surface
- XA** NUKR .. A and NUKRE .. A design cam followers with a cylindrical (flat) profile of the outer ring running surface
- Z** Combined needle roller bearings, axial bearing with a cover over the outside diameter without lubrication holes. Filled at the factory with a high-quality lithium base NLGI 2 grease.
- ZW** Double row needle roller and cage assembly
- .2ZL** Support rollers with a lamellar seal on both sides

Application of bearings

The bearing arrangement of a rotating machine component such as a shaft generally requires locating and a non-locating bearing arrangement to support and locate the component radially and axially relative to the housing. As radial needle roller bearings can accommodate axial displacement within the bearing, they generally are used as non-locating bearings.

Needle roller thrust bearings can only accommodate axial loads acting in one direction. A double direction needle roller thrust bearing can be created by combining two needle roller and cage thrust assemblies and bearing washers with an intermediate washer. Radial loads must be accommodated by a combined needle roller bearing or a separate radial bearing.

Combined needle roller bearings can accommodate radial loads and axial loads in one direction only. Therefore, a second combined needle roller bearing is required to be able to take axial loads in the opposite direction (except NKIB series needle roller bearings that can accommodate axial loads in both directions).

For additional information about bearing arrangements, refer to the SKF *General Catalogue*. The application information for bearings provided in the SKF *General Catalogue* is also valid for needle roller bearings.

If necessary, the introductory text of each product chapter provides information about

- axial guidance
- axial and radial location
- recommended fits for shafts and housings

Design of associated components

Form and running accuracy

Good running accuracy, required speeds and low operating temperatures can only be achieved if the associated components and other mating parts are manufactured with equal precision as the needle roller bearings. Deviations from geometric form of associated seats and abutments must be kept to a minimum. The parts should be machined according to the following recommendations.

Table 1

Limits for ISO tolerance grades

Nominal dimension over incl.		Tolerance grades					
		IT2 max	IT3	IT4	IT5	IT6	IT7
mm		µm					
1	3	1,2	2	3	4	6	10
3	6	1,5	2,5	4	5	8	12
6	10	1,5	2,5	4	6	9	15
10	18	2	3	5	8	11	18
18	30	2,5	4	6	9	13	21
30	50	2,5	4	7	11	16	25
50	80	3	5	8	13	19	30
80	120	4	6	10	15	22	35
120	180	5	8	12	18	25	40
180	250	7	10	14	20	29	46
250	315	8	12	16	23	32	52
315	400	9	13	18	25	36	57
400	500	10	15	20	27	40	63

Dimensional tolerances

For bearings manufactured to Normal tolerances, the dimensional accuracy of cylindrical seats on the shaft should be at least grade 6 and in the housing at least grade 7. For bearings with higher accuracy, correspondingly better grades should be used. The numerical values of standard IT tolerance grades, in accordance with ISO 286-1:1988, are listed in **table 1**.

Table 2

Accuracy of form and position for bearing seats on shafts and in housings

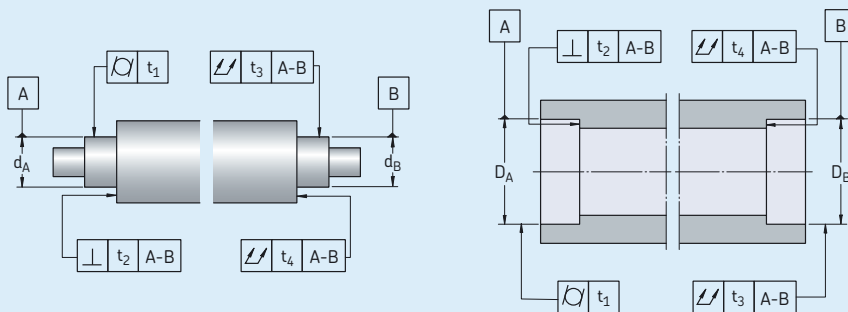

Surface Characteristic	Symbol for characteristic	tolerance zone	Permissible deviation Bearings of tolerance class ¹⁾		
			Normal	P6	P5
Cylindrical seat					
Cylindricity	\bigcirc	t_1	$\frac{IT5}{2}$	$\frac{IT4}{2}$	$\frac{IT3}{2}$
Total radial runout	\diagup	t_3	$\frac{IT5}{2}$	$\frac{IT4}{2}$	$\frac{IT3}{2}$
Flat abutment					
Perpendicularity	\perp	t_2	IT5	IT4	IT3
Total axial runout	\diagdown	t_4	IT5	IT4	IT3

¹⁾ The basic tolerance classes stated are valid for normal demands on the bearing arrangement. For special demands in respect of running accuracy or even support, the bearing seat should be machined to the basic tolerance classes recommended for the next higher bearing tolerance class.

Tolerances for cylindrical form

The cylindricity tolerances as defined in ISO 1101-2004 should be one to two IT grades better than the prescribed dimensional tolerance, depending on requirements. For example, if a bearing shaft seat has been manufactured to m6 tolerance class, then the accuracy of form should be to IT5 or IT4 tolerance grade. The tolerance value for cylindricity, t_1 , is obtained for an assumed shaft diameter of 150 mm from $t_1 = IT5/2 = 18/2 = 9 \mu\text{m}$. However, the tolerance t_1 is for a radius, hence $2 t_1$ applies for the shaft diameter. Guideline values for the cylindrical form tolerance and the total runout tolerance for the different bearing tolerance classes are listed in **table 2 on page 49**.

Tolerances for perpendicularity

Abutments for bearing rings should have a rectangularity tolerance as defined in ISO 1101-2004, which is better by at least one IT grade than the diameter tolerance of the associated cylindrical seat. For thrust bearing washer seats, the tolerance for perpendicularity should not exceed IT5 tolerance grade. Guideline values for the tolerance for rectangularity and for the total axial runout are listed in **table 2 on page 49**.

Surface roughness of bearing seats

The surface roughness of a bearing seat does not have the same degree of influence on bearing performance as the dimensional, form and running accuracies. However, the accuracy of an interference fit is directly proportional to the smoothness of the mating surface.

For bearing arrangements where accuracy is a key operational parameter, guideline values for the mean surface roughness R_a are listed in **table 3**. These recommendations apply to ground seats, which are normally assumed for shaft seats.

Raceways on shafts and in housings

Raceway hardness and its influence

If the load carrying capacity of the bearing or assembly is to be fully exploited, the raceways machined in associated components must be hardened to between 58 and 64 HRC.

Raceway surface finish and accuracy

The surface roughness should be $R_a \leq 0,2 \mu\text{m}$ or $R_z \leq 1 \mu\text{m}$. For less demanding applications, rougher surfaces may be used.

The out-of-round and deviation from cylindrical form must not exceed 25 and 50%, respectively, of the actual diameter tolerance of the raceway.

The permissible axial runouts of raceways for thrust assemblies are the same as for the shaft and housing washers of thrust bearings, listed in **table 5 on page 41**.

Raceway materials

Suitable materials for the raceways include steel for through-hardening, e.g. 100Cr6 in accordance with ISO 683-17:1999, steels for case-hardening, e.g. 20Cr3 or 17MnCr5 in accordance with ISO 683-17:1999) as well as steels for induction-hardening that can be surface hardened.

Table 3

Guideline values for surface roughness of bearing seats

Diameter of seat $d(D)$ over		Recommended R_a value for ground seats		
		Diameter tolerance to		
	incl.	IT7	IT6	IT5
mm		μm		
–	80	1,6 (N7)	0,8 (N6)	0,4 (N5)
80	500	1,6 (N7)	1,6 (N7)	0,8 (N6)

The recommended hardening depth for raceways machined in associated components depends on various factors including the dynamic and static load ratios (P/C and P_0/C_0 respectively) as well as the core hardness of the component. Therefore, it is difficult to make generalizations regarding hardening depth. For example, under conditions of purely static load up to the magnitude of the basic static load rating and with a core hardness of 350 HV, the recommended hardening depth is in the order of 0,1 times the rolling element diameter. For dynamic loads, however, smaller hardening depths are permitted. For additional information, contact the SKF application engineering service.

Lubrication

If rolling bearings are to operate reliably they must be adequately lubricated to prevent direct metal-to-metal contact between the rolling elements, raceways and cages. The lubricant also inhibits wear and protects the bearing surfaces against corrosion. The choice of a suitable lubricant and method of lubrication for each individual bearing application is therefore important, as is adequate maintenance.

Differences in the lubricating properties of seemingly identical lubricants – particularly grease – produced at different locations can exist. As a result, SKF will not accept responsibility for the performance of any of its lubricants. The user is therefore advised to specify lubricant properties in detail so as to obtain the most suitable lubricant for the application.

The SKF traffic light concept

Most grease suppliers indicate the specific values for the low and high temperature limits in their product information. The SKF traffic light concept is distinctly different from that. SKF recognizes that the really important temperatures for reliable operation lie within a smaller range. This range depends largely on the type of base oil and thickener used, as well as the additives. The relevant temperatures are given by the SKF traffic light concept. They are schematically illustrated in **diagram 1** in the form of a double traffic light.

It is clear that grease in the red zones should not be applied at all, as damage may occur. Within the green zone, the grease will function reliably and the grease life can be determined accurately.

At temperatures in the amber zone above the high temperature performance limit (HTPL), grease will age and oxidize with increasing rapidity and the by-products of the oxidation will have a detrimental effect on lubrication. An amber zone also exists for low temperatures. Short periods in this zone such as during a cold start are not harmful since the heat caused by friction will bring the bearing temperature into the green zone.

For additional information about the SKF traffic light concept, refer to the SKF *General Catalogue* (section *Lubrication*).

Lubricating greases

The following explains basics concerning initial grease fills, if available, and gives recommendations for SKF greases that can be used for relubrication. Certain features, which facilitate efficient lubrication and relubrication of the bearings are provided in the introductory text of the individual product chapters.

For additional information about lubrication and calculation of relubrication intervals, refer to the SKF *General Catalogue* (section *Lubrication*). The SKF grease selection program *Lube Select* available online at www.aptitudeexchange.com provides a more detailed selection of appropriate greases.

Initial grease fill

Sealed needle roller bearings and track runner bearings

The following bearings are filled at the factory with the same high-quality grease with good corrosion inhibiting properties:

- sealed needle roller bearings
- thrust part of combined bearings with the designation suffix Z
- cam followers
- support rollers

SKF recommends SKF LGWA 2 grease, if relubrication is required.

The most important technical specifications for grease for initial fill and for relubrication are listed in **table 1** on **page 54**.

Diagram 1

The SKF traffic light concept – general

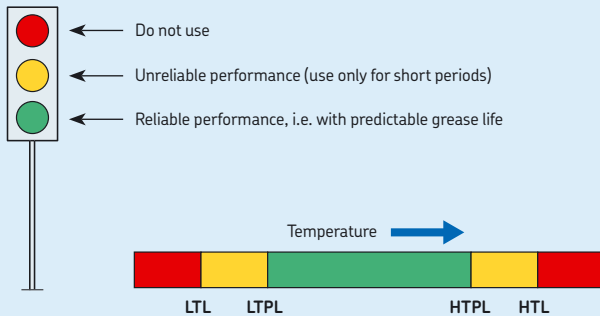

LTL – Low temperature limit

The lowest temperature at which the grease will enable the bearing to be started up without difficulty

LTPL – Low temperature performance limit

Below this limit, the supply of grease to the contact surfaces of rolling elements and raceways may become insufficient

HTPL – High temperature performance limit

Above this limit the grease will age and oxidize in an uncontrolled way, so that grease life cannot be determined accurately

HTL – High temperature limit

When exceeding this limit, the grease loses its structure permanently

Lubrication

Full complement drawn cup needle roller bearings

Special grease is used for full complement drawn cup needle roller bearings to secure the rollers during transportation. However, this grease does not provide sufficient long term lubrication. Therefore, relubrication after mounting may be necessary. Depending on the required consistency class, SKF recommends SKF LGEP 2 or SKF LGMW 1 greases for relubrication. Characteristics for the greases are listed in **table 2**.

Table 1

Lubricating greases for sealed needle roller bearings and track runner bearings

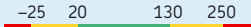
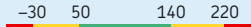
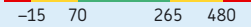
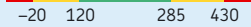
	Initial grease fill	LGWA 2
Thickener	Lithium complex soap	Lithium complex soap
Base oil type	Mineral	Mineral
NLGI consistency class	2	2
Temperature range¹⁾ [°C]		
[°F]		
Base oil viscosity [mm²/s] at 40 °C	160	185
at 100 °C	15,5	15

¹⁾ Refer to the SKF traffic light concept.

Table 2

Greases for full complement drawn cup needle roller bearings

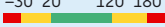
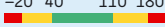
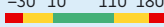
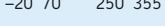
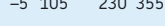
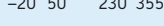
	Initial grease fill	LGEP 2	LGMW 1
Thickener	Lithium soap	Lithium soap	Lithium soap
Base oil type	Mineral	Mineral	Mineral
NLGI consistency class	1 – 2	2	1
Temperature range¹⁾ [°C]			
[°F]			
Base oil viscosity [mm²/s] at 40 °C	200	200	200
at 100 °C	18,7	16	16

¹⁾ Refer to the SKF traffic light concept.



Needle roller and cage assemblies

Dimensions.....	58
Tolerances	60
Operational clearance.....	60
Misalignment.....	61
Cages	62
Abutment dimensions.....	63
Supplementary designations.....	63
Product tables	64
2.1 Needle roller and cage assemblies.....	64

Needle roller and cage assemblies

Needle roller and cage assemblies are ready-to-mount, self-contained bearing components. They are an excellent choice for applications that require a very rigid bearing arrangement as well as a high load carrying capacity. If the shaft and housing bore can serve as raceways, needle roller and cage assemblies require minimal radial space.

Standard needle roller and cage assemblies

SKF supplies needle roller and cage assemblies in single row (→ **fig. 1**) and double row (→ **fig. 2**) designs. They are characterized by:

- a simple and rugged design
- accurate guidance of the rollers in the cage pockets
- good running performance

Other needle roller and cage assemblies

Only part of SKF's comprehensive assortment of needle roller and cage assemblies is listed in the product tables. SKF also supplies other sizes and assemblies with cages that differ from the standard design, such as needle roller and cage assemblies with a split cage (→ **fig. 3**) that can be used where raceways are recessed in the shaft.

For connecting rods of internal combustion engines and compressors, SKF supplies special needle roller and cage assemblies for the gudgeon (wrist) pin (→ **fig. 4**) and crank pin (crankshaft

journal) (→ **fig. 5**). The assemblies for these applications can provide excellent service in spite of high accelerations, high temperatures, unfavourable load conditions or poor lubrication conditions.

SKF also supplies special sizes of needle roller and cage assemblies to special order. Details of these other needle roller and cage assemblies are available on request.

Dimensions

The dimensions of needle roller and cage assemblies with an inside diameter up to and including 100 mm, where standardized, are in accordance with ISO 3030:1996.

Fig. 1

Needle roller and cage assembly, single row

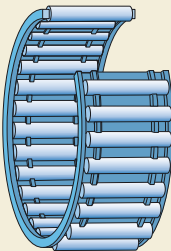

K series

Fig. 2

Needle roller and cage assembly, double row

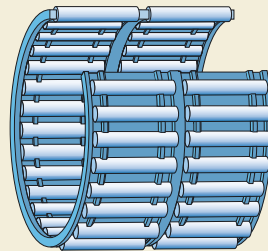

K .. ZW series

Bearing arrangement incorporating split needle roller and cage assemblies

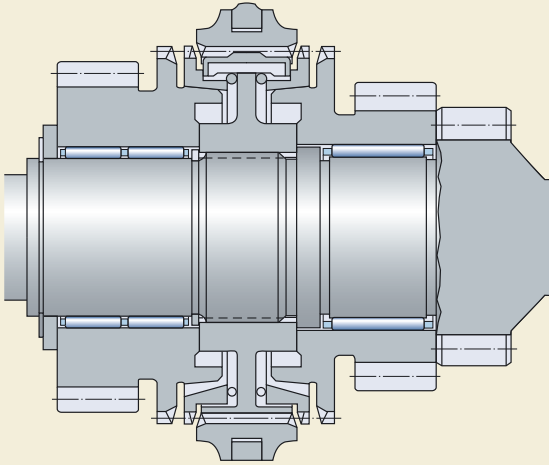

Fig. 4

Needle roller and cage assembly for gudgeon pin bearing arrangements

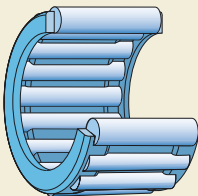
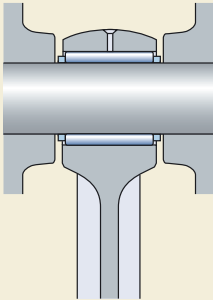
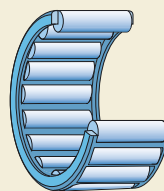
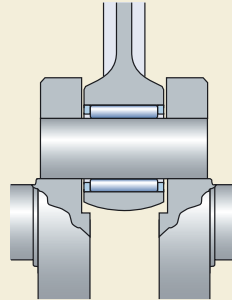

Fig. 5

Needle roller and cage assembly for crank pin bearing arrangements



Tolerances

SKF needle roller and cage assemblies contain rollers of one gauge of grade G2 (ISO 3096: 1996 Grade 2). The tolerance of each gauge is 2 µm. The deviation from the nominal dimensions of the needle rollers is printed on the package.

SKF needle roller and cage assemblies may comprise, as standard, assemblies of any standard gauge (→ **table 1**). If a specific gauge is required, it must be stated when ordering. Assemblies with rollers of a special gauge (→ **table 1**) are only available by special order on request.

The tolerances for the width U are -0,20/-0,80 mm for all needle roller and cage assemblies.

Paired mounting

Needle roller and cage assemblies that are mounted immediately adjacent to each other must incorporate rollers of the same gauge. This will enable both assemblies to share the load equally.

Operational clearance

The radial operational clearance of bearing arrangements incorporating needle roller and cage assemblies is determined by:

- the gauge of the needle rollers
- the shaft and housing raceway tolerances
- the operating temperature

Suitable raceway tolerance classes are listed in **table 2**. If these tolerances are applied when using assemblies with standard gauge rollers (→ **table 1**), under normal conditions the operational clearance will reach a value in the range of C2 to Normal radial internal clearance (→ **table 7, page 42**).

If a specific radial internal clearance is required, the various components of the arrangement should be matched following a mounting scheme similar to the one shown in **table 3**. The mean value of the needle roller gauge should be used to calculate the internal clearance, e.g. -6 µm for the gauge -5 to -7 µm.

Table 1

Needle roller gauges	
Gauge type	Gauge in µm
Standard gauges	0/-2
	-1/-3
	-2/-4
	-3/-5
	-4/-6
	-5/-7
Special gauges (to order)	-6/-8
	-7/-9
	-8/-10
	-9/-11

Table 2

Raceway tolerance classes for needle roller and cage assemblies				
Shaft Nominal diameter	Housing/shaft tolerance classes for operational clearance	Housing/shaft tolerance classes		
		lower side	medium side	higher side
over	incl.			
mm		-		
-	80	G6/j5 H6/h5	G6/h5 H6/g5	G6/g6 H6/f6
80	120	G6/h5	G6/g5	G6/f6
120	-	G6/h5 -	G6/g5 H6/f5	G6/f6 H6/e6

Misalignment

The ends of the needle rollers are relieved slightly to modify the line contact between the raceways and the rollers. This provides favourable load distribution in the needle roller and cage assembly and minimizes damaging edge stresses. It also enables single row needle roller and cage assemblies to accommodate a small amount of misalignment, approximately 1 min of arc between the shaft and housing.

The detrimental effects of misalignment increase with increasing bearing width and load. For additional information, contact the SKF application engineering service.

Table 3

Mounting scheme – example

Needle roller and cage assembly: K16×22×12
 Housing bore diameter: 22H6 (mm), deviation 0/+13 μm
 Shaft diameter: 16h5 (mm), deviation 0/−8 μm

Shaft diameter Deviation group	Housing bore diameter							
	Deviation groups 0 to +3		+3 to +6		+6 to +9		+9 to +13	
	Needle roller gauge limits	Radial internal clearance	Needle roller gauge limits	Radial internal clearance	Needle roller gauge limits	Radial internal clearance	Needle roller gauge limits	Radial internal clearance
μm	μm							
0 to −3					−5/−7	18–24	−3/−5	17–24
−3 to −6			−5/−7	18–24	−3/−5 −4/−6	17–25	−2/−4	18–25
−6 to −8	−5/−7 −6/−8	18–25	−3/−5 −4/−6	17–24	−2/−4 −3/−5	18–25	0/−2 −1/−3	17–25

Cages

SKF needle roller and cage assemblies are fitted, as standard, with a machined steel cage (→ **fig. 6**) or a sheet steel cage (→ **fig. 7**), with the exception of assemblies identified by the designation suffix TN. These have an injection moulded glass fibre reinforced polyamide 66 cage (→ **fig. 8**).

Note

Needle roller and cage assemblies with a polyamide 66 cage can be operated at temperatures up to 120 °C. The lubricants generally used for rolling bearings do not have a detrimental effect on cage properties. Exceptions are a few synthetic oils and greases with a synthetic oil base and lubricants containing a high proportion of EP additives when used at high temperatures.

For bearing arrangements that operate at continuously high temperatures or under arduous conditions, SKF recommends using assemblies with a steel cage.

For additional information about the temperature resistance and the applicability of cages, refer to the section *Cage materials*, starting on **page 44**.

Fig. 6

Machined steel cage

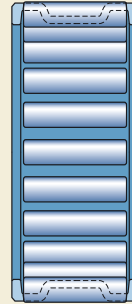

Fig. 7

Sheet steel cage



Fig. 8

Polyamide 66 cage

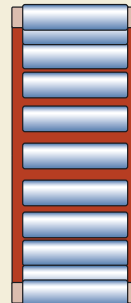

Abutment dimensions

Needle roller and cage assemblies should be axially guided. The lateral abutment surfaces should be fine turned and polished. For high speed operation they should be hardened and ground. Interruptions in the surface should be avoided. Snap rings can be used in less demanding applications, otherwise an intermediate ring, e.g. a spring steel washer, should be placed between the snap ring and the assembly. Appropriate values for the abutment diameters on the shaft and in the housing are listed in **table 4**.

Supplementary designations

The designation suffixes used to identify certain features of SKF needle roller and cage assemblies are explained in the following.

- DS** Split needle roller and cage assembly
/SORT.. Tolerance grade of needle rollers of a needle roller and cage assembly, the figures following give the actual limits in μm , e.g. /SORT-2-4
- TN** Injection moulded cage of glass fibre reinforced polyamide 66
- VG052** Single split cage of polyethersulfone (PES)
- ZW** Double row needle roller and cage assembly (double row cage)

Table 4

Abutment dimensions for needle roller and cage assemblies

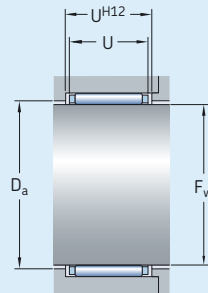
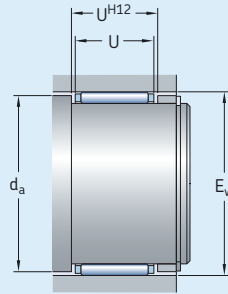

Needle roller and cage assembly Inside diameter		Shaft abutment	Housing abutment
F_w over	incl.	d_a	D_a
mm		mm	mm
–	25	$E_w-0,3$	$F_w+0,4$
25	65	$E_w-0,5$	$F_w+0,5$
65	–	E_w-1	F_w+1

Needle roller and cage assemblies

F_w 3 – 19 mm

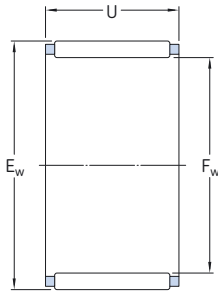

K

Dimensions			Basic load ratings		Fatigue load limit	Speed ratings		Mass	Designation	Appropriate seal ¹⁾ Designation
F_w	E_w	U	dynamic	static		Reference speed	Limiting speed			
			C	C_0	P_u					
mm			kN		kN	r/min		g	–	–
3	5	7	1,51	1,34	0,134	40 000	45 000	0,3	K 3×5×7 TN	–
	5	9	1,72	1,63	0,17	38 000	43 000	0,4	K 3×5×9 TN	–
	6	7	1,42	1,02	0,104	38 000	43 000	0,4	K 3×6×7 TN	–
4	7	7	1,72	1,32	0,137	36 000	43 000	0,5	K 4×7×7 TN	–
	7	10	2,29	1,9	0,204	36 000	43 000	0,7	K 4×7×10 TN	–
5	8	8	2,29	2	0,212	36 000	40 000	0,7	K 5×8×8 TN	–
	8	10	2,92	2,7	0,29	36 000	40 000	0,9	K 5×8×10 TN	–
6	9	8	2,55	2,36	0,25	34 000	38 000	0,8	K 6×9×8 TN	–
	9	10	3,3	3,2	0,345	34 000	38 000	1,1	K 6×9×10 TN	–
	10	13	3,69	3,15	0,36	34 000	38 000	1,9	K 6×10×13 TN	G 6×10×2 S
7	9	7	1,68	1,83	0,19	34 000	38 000	0,6	K 7×9×7 TN	–
	10	8	2,81	2,75	0,29	32 000	36 000	0,9	K 7×10×8 TN	–
	10	10	3,58	3,75	0,415	32 000	36 000	1,0	K 7×10×10 TN	–
8	11	8	3,03	3,1	0,335	32 000	36 000	1,0	K 8×11×8 TN	–
	11	10	3,8	4,25	0,465	32 000	36 000	1,2	K 8×11×10 TN	–
	11	13	5,01	5,85	0,67	32 000	36 000	1,7	K 8×11×13 TN	–
	12	10	4,84	4,75	0,54	30 000	34 000	2,0	K 8×12×10 TN	G 8×12×3
9	12	10	4,4	5,2	0,57	30 000	34 000	1,5	K 9×12×10 TN	–
	12	13	5,72	7,2	0,815	30 000	34 000	2,1	K 9×12×13 TN	–
10	13	10	4,57	5,7	0,63	28 000	32 000	1,6	K 10×13×10 TN	–
	13	13	5,94	8	0,9	28 000	32 000	2,3	K 10×13×13 TN	–
	13	16	6,82	9,5	1,08	28 000	32 000	2,9	K 10×13×16 TN	–
	14	10	5,61	6,1	0,695	28 000	32 000	2,5	K 10×14×10 TN	G 10×14×3
	14	13	5,83	6,3	0,72	28 000	32 000	4,6	K 10×14×13 TN	G 10×14×3
	16	12	7,65	7,2	0,85	28 000	32 000	5,5	K 10×16×12 TN	–
12	15	10	4,73	6,2	0,695	26 000	30 000	1,9	K 12×15×10 TN	–
	15	13	6,16	8,65	0,98	26 000	30 000	2,3	K 12×15×13 TN	–
	16	13	7,65	9,5	1,1	26 000	30 000	3,6	K 12×16×13 TN	G 12×16×3
	17	13	9,13	10,4	1,22	26 000	30 000	4,9	K 12×17×13 TN	–
	18	12	9,52	10	1,18	26 000	30 000	6,0	K 12×18×12 TN	G/SD 12×18×3

¹⁾ For additional information, refer to the section *Radial shaft seals with a low cross sectional height*, starting on page 208.

Dimensions			Basic load ratings		Fatigue load limit	Speed ratings		Mass	Designation	Appropriate seal ¹⁾
F _w	E _w	U	C	C ₀	P _u	Reference speed	Limiting speed			Designation
mm			kN		kN	r/min		g	–	–
14	18	10	6,93	8,65	1	24 000	28 000	4,0	K 14×18×10	–
	18	13	7,92	10,2	1,18	24 000	28 000	6,5	K 14×18×13	–
	18	15	9,13	12,5	1,46	24 000	28 000	5,0	K 14×18×15 TN	–
	18	17	10,5	14,6	1,7	24 000	28 000	8,0	K 14×18×17	–
	20	12	9,9	10,6	1,25	24 000	28 000	8,5	K 14×20×12	G/SD 14×20×3
15	18	17	7,65	12,2	1,4	24 000	28 000	4,6	K 15×18×17 TN	–
	19	10	7,21	9,3	1,06	24 000	28 000	5,0	K 15×19×10	–
	19	13	8,25	11,2	1,29	24 000	28 000	7,0	K 15×19×13	–
	19	17	10,8	15,6	1,86	24 000	28 000	9,5	K 15×19×17	–
	20	13	9,52	11,6	1,34	24 000	26 000	7,0	K 15×20×13	–
	21	15	13,8	16,3	2	24 000	26 000	11	K 15×21×15	G/SD 15×21×3
	21	21	18,7	24,5	3	24 000	26 000	17	K 15×21×21	G/SD 15×21×3
16	20	10	7,48	10	1,16	24 000	26 000	5,5	K 16×20×10	–
	20	13	8,58	12	1,37	24 000	26 000	7,5	K 16×20×13	–
	20	17	11,2	17	2	24 000	26 000	10	K 16×20×17	–
	22	12	11	12,5	1,5	22 000	26 000	10	K 16×22×12	G/SD 16×22×3
	22	16	14,2	17,6	2,12	22 000	26 000	12	K 16×22×16	G/SD 16×22×3
	22	20	17,6	22,8	2,8	22 000	26 000	17	K 16×22×20	G/SD 16×22×3
	24	20	20,5	23,6	2,9	22 000	24 000	22	K 16×24×20	G/SD 16×24×3
	24	20	20,5	23,6	2,9	22 000	24 000	22	K 16×24×20	G/SD 16×24×3
17	21	10	7,81	10,8	1,22	22 000	26 000	5,5	K 17×21×10	–
	21	13	10,1	14,6	1,73	22 000	26 000	6,5	K 17×21×13	–
	21	17	11,7	18,3	2,12	22 000	26 000	9,5	K 17×21×17	–
18	22	10	8,09	11,4	1,32	22 000	24 000	6,0	K 18×22×10	–
	22	13	8,8	12,9	1,5	22 000	24 000	8,0	K 18×22×13	–
	22	17	11,7	18,3	2,16	22 000	24 000	11	K 18×22×17	–
	24	12	12,1	15	1,8	20 000	24 000	12	K 18×24×12	G/SD 18×24×3
	24	13	12,5	15,3	1,86	20 000	24 000	13	K 18×24×13	G/SD 18×24×3
	24	20	19,4	27	3,25	20 000	24 000	18	K 18×24×20	G/SD 18×24×3
	25	22	22	29	3,55	20 000	24 000	23	K 18×25×22	–
19	23	13	9,13	13,7	1,6	20 000	24 000	8,0	K 19×23×13	–
	23	17	12,1	19,3	2,28	20 000	24 000	11	K 19×23×17	–

¹⁾ For additional information, refer to the section *Radial shaft seals with a low cross sectional height*, starting on **page 208**.

Needle roller and cage assemblies

F_w 20 – 30 mm

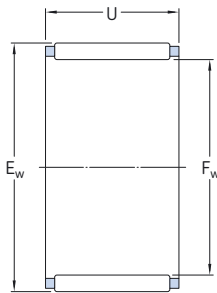

K

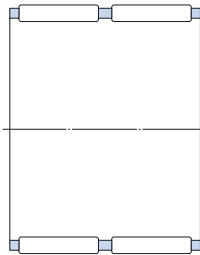

K..ZW

Dimensions			Basic load ratings		Fatigue load limit	Speed ratings		Mass	Designation	Appropriate seal ¹⁾
F_w	E_w	U	C	C_0	P_u	Reference speed	Limiting speed			Designation
mm			kN		kN	r/min		g	–	–
20	24	10	8,58	12,9	1,46	20 000	22 000	6,5	K 20×24×10	–
	24	13	9,52	14,6	1,66	20 000	22 000	9,0	K 20×24×13	–
	24	17	12,5	20,8	2,4	20 000	22 000	12	K 20×24×17	–
	26	12	12,8	16,3	1,96	19 000	22 000	11	K 20×26×12	G/SD 20×26×4
	26	13	13,8	18	2,16	19 000	22 000	12	K 20×26×13	G/SD 20×26×4
	26	17	18,3	26	3,2	19 000	22 000	16	K 20×26×17	G/SD 20×26×4
	26	20	20,1	29	3,6	19 000	22 000	19	K 20×26×20	G/SD 20×26×4
	28	16	19	22,4	2,7	18 000	20 000	20	K 20×28×16	G/SD 20×28×4
	28	20	22,9	28,5	3,45	18 000	20 000	27	K 20×28×20	G/SD 20×28×4
	28	25	29,2	39	4,9	18 000	20 000	32	K 20×28×25	G/SD 20×28×4
30	30	34,1	41,5	5,2	17 000	20 000	49	K 20×30×30	–	
21	25	13	9,68	15,3	1,76	19 000	22 000	9,0	K 21×25×13	–
22	26	10	8,8	13,7	1,56	18 000	20 000	7,5	K 22×26×10	–
	26	13	10,1	16,3	1,86	18 000	20 000	9,5	K 22×26×13	–
	26	17	13,2	22,8	2,7	18 000	20 000	12	K 22×26×17	–
	28	17	18,3	27	3,25	17 000	20 000	18	K 22×28×17	G/SD 22×28×4
	29	16	19,4	25,5	3,05	17 000	19 000	16	K 22×29×16	–
	30	15	19	23,6	2,8	17 000	19 000	18	K 22×30×15 TN	G/SD 22×30×4
	32	24	31,9	40	4,9	16 000	18 000	43	K 22×32×24	–
23	35	16	24,2	23,2	2,9	15 000	17 000	29	K 23×35×16 TN	–
24	28	10	9,35	15	1,73	17 000	19 000	8,5	K 24×28×10	–
	28	13	10,6	18	2,08	17 000	19 000	10	K 24×28×13	–
	28	17	14	25,5	3	17 000	19 000	13	K 24×28×17	–
	30	17	18,7	27,5	3,4	16 000	18 000	19	K 24×30×17	–
	30	31	26,4	43	5,3	16 000	18 000	32	K 24×30×31 ZW	–

¹⁾ For additional information, refer to the section *Radial shaft seals with a low cross sectional height*, starting on page 208.

Dimensions			Basic load ratings		Fatigue load limit	Speed ratings		Mass	Designation	Appropriate seal ¹⁾
F _w	E _w	U	C	C ₀	P _u	Reference speed	Limiting speed			Designation
mm			kN		kN	r/min		g	–	–
25	29	10	9,52	15,6	1,8	16 000	18 000	8,5	K 25×29×10	–
	29	13	10,8	18,6	2,16	16 000	18 000	11	K 25×29×13	–
	29	17	14,2	26,5	3,1	16 000	18 000	14	K 25×29×17	–
	30	17	17,9	30,5	3,6	16 000	18 000	16	K 25×30×17	–
	30	20	20,9	36,5	4,4	16 000	18 000	18	K 25×30×20	–
	30	26	20,5	36	4,15	16 000	18 000	19	K 25×30×26 ZW	–
	31	17	18,7	28,5	3,45	16 000	18 000	19	K 25×31×17	–
	31	21	23,3	38	4,75	16 000	18 000	20	K 25×31×21	–
	32	16	19,8	27,5	3,35	15 000	17 000	21	K 25×32×16	G 25×32×4
	33	20	27,5	38	4,65	15 000	17 000	33	K 25×33×20	G/SD 25×33×4
	33	24	31,9	47,5	5,85	15 000	17 000	39	K 25×33×24	G/SD 25×33×4
	35	30	44,6	62	7,8	15 000	17 000	65	K 25×35×30	G/SD 25×35×4
	26	30	13	11,2	19,6	2,28	16 000	18 000	11	K 26×30×13
30		17	14,7	27,5	3,25	16 000	18 000	15	K 26×30×17	–
30		22	15,1	29	3,35	16 000	18 000	12	K 26×30×22 ZW	–
28	33	13	14,7	24,5	2,85	14 000	16 000	13	K 28×33×13	–
	33	17	19	33,5	4,05	14 000	16 000	17	K 28×33×17	–
	34	17	20,9	33,5	4,15	14 000	16 000	24	K 28×34×17	–
	35	16	20,5	30	3,55	14 000	16 000	24	K 28×35×16	G/SD 28×35×4
	35	18	22,9	34,5	4,15	14 000	16 000	27	K 28×35×18	G/SD 28×35×4
	40	25	42,9	55	6,95	13 000	15 000	70	K 28×40×25	–
30	34	13	11,9	22	2,55	14 000	15 000	14	K 30×34×13	–
	35	13	15,1	25,5	3	13 000	15 000	14	K 30×35×13	–
	35	17	18,7	34	4,05	13 000	15 000	19	K 30×35×17	–
	35	27	29,2	60	7,35	13 000	15 000	30	K 30×35×27	–
	37	16	22	33,5	4	13 000	15 000	27	K 30×37×16	G/SD 30×37×4
	37	18	25,1	39	4,65	13 000	15 000	30	K 30×37×18	G/SD 30×37×4
	40	18	30,3	40	4,9	12 000	14 000	48	K 30×40×18	G/SD 30×40×4
	40	30	46,8	69,5	8,65	12 000	14 000	73	K 30×40×30	G/SD 30×40×4

¹⁾ For additional information, refer to the section *Radial shaft seals with a low cross sectional height*, starting on page 208.

Needle roller and cage assemblies

F_w 32 – 55 mm

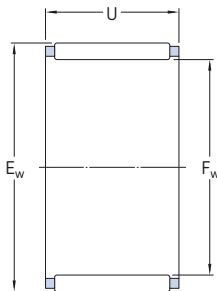

K

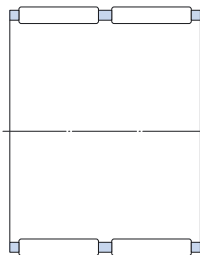

K..ZW

Dimensions			Basic load ratings		Fatigue load limit	Speed ratings		Mass	Designation	Appropriate seal ¹⁾ Designation
F _w	E _w	U	dynamic	static		Reference speed	Limiting speed			
mm			kN		kN	r/min		g	–	–
32	37	13	14,7	25,5	3	13 000	14 000	18	K 32×37×13	–
	37	17	19	35,5	4,25	13 000	14 000	19	K 32×37×17	–
	37	27	28,6	60	7,35	13 000	14 000	30	K 32×37×27	–
	38	20	25,1	45	5,6	12 000	14 000	30	K 32×38×20	–
	39	16	22,9	35,5	4,25	12 000	14 000	37	K 32×39×16	–
	39	18	25,5	41,5	5	12 000	14 000	31	K 32×39×18	–
	40	25	35,8	58,5	7,2	12 000	14 000	49	K 32×40×25	–
	40	42	48,4	83	10,2	14 000	12 000	77	K 32×40×42 ZWTN	–
	46	32	62,7	83	10,4	11 000	13 000	119	K 32×46×32	–
35	40	13	15,4	28	3,25	12 000	13 000	19	K 35×40×13	–
	40	17	19,8	39	4,65	12 000	13 000	21	K 35×40×17	–
	40	25	28,1	60	7,35	12 000	13 000	31	K 35×40×25	–
	40	27	23,8	49	6	12 000	13 000	39	K 35×40×27 TN	–
	42	16	23,3	37,5	4,5	11 000	13 000	34	K 35×42×16	G/SD 35×42×4
	42	18	26,4	44	5,3	11 000	13 000	34	K 35×42×18	G/SD 35×42×4
	42	20	29,2	50	6	11 000	13 000	37	K 35×42×20	G/SD 35×42×4
	42	30	37,4	68	8,5	11 000	13 000	67	K 35×42×30	G/SD 35×42×4
	45	20	35,2	50	6,2	11 000	12 000	56	K 35×45×20	G/SD 35×45×4
	45	30	50,1	80	10	11 000	12 000	80	K 35×45×30	G/SD 35×45×4
37	42	17	21,6	43	5,2	11 000	13 000	22	K 37×42×17	–
38	43	17	19,8	39	4,65	11 000	12 000	29	K 38×43×17	–
	43	27	30,3	68	8,3	11 000	12 000	43	K 38×43×27	–
	46	20	34,1	57	6,95	10 000	12 000	47	K 38×46×20	–
	46	32	52,3	100	12,5	10 000	12 000	76	K 38×46×32	–
39	44	26	26	57	6,7	10 000	12 000	45	K 39×44×26 ZW	–
40	45	13	16,8	32,5	3,8	10 000	12 000	22	K 40×45×13	–
	45	17	20,5	41,5	5	10 000	12 000	31	K 40×45×17	–
	45	27	31,4	73,5	9	10 000	12 000	46	K 40×45×27	–
	47	18	28,6	50	6,1	10 000	11 000	39	K 40×47×18	G/SD 40×47×4
	47	20	31,4	57	6,95	10 000	11 000	42	K 40×47×20	G/SD 40×47×4
	48	20	34,7	58,5	7,35	10 000	11 000	49	K 40×48×20	–

¹⁾ For additional information, refer to the section *Radial shaft seals with a low cross sectional height*, starting on page 208.

Dimensions			Basic load ratings		Fatigue load limit	Speed ratings		Mass	Designation	Appropriate seal ¹⁾
F _w	E _w	U	C	C ₀	P _u	Reference speed	Limiting speed			Designation
mm			kN		kN	r/min		g	–	–
42	47	13	17,2	33,5	4	10 000	11 000	18	K 42×47×13	–
	47	17	20,9	43	5,2	10 000	11 000	32	K 42×47×17	–
	47	30	31,9	76,5	9	10 000	11 000	54	K 42×47×30 ZW	–
	50	20	31,9	54	7,2	9 500	11 000	53	K 42×50×20	–
43	48	17	20,9	43	5,2	9 500	11 000	30	K 43×48×17	–
	48	27	31,9	76,5	9,3	9 500	11 000	50	K 43×48×27	–
45	50	17	21,6	46,5	5,6	9 000	10 000	34	K 45×50×17	–
	50	27	33	81,5	10	9 000	10 000	51	K 45×50×27	–
	52	18	30,3	57	6,95	9 000	10 000	42	K 45×52×18	G/SD 45×52×4
	53	20	37,4	68	8,3	9 000	10 000	55	K 45×53×20	–
	53	21	36,9	67	8,3	9 000	10 000	60	K 45×53×21	–
	53	28	49,5	98	12,2	9 000	10 000	81	K 45×53×28	–
	59	18	44	53	6,55	8 500	9 500	72	K 45×53×18 TN	–
	59	32	69,3	102	12,9	8 500	9 500	148	K 45×59×32	–
47	52	17	22,4	49	6	9 000	10 000	35	K 47×52×17	–
	52	27	33,6	83	10,2	9 000	10 000	51	K 47×52×27	–
50	55	13,5	17,6	36,5	4,3	8 500	9 500	30	K 50×55×13.5	–
	55	17	21,2	47,5	5,7	8 500	9 500	35	K 50×55×17	–
	55	20	25,5	60	7,2	8 500	9 500	43	K 50×55×20	–
	55	30	37,4	98	12	8 500	9 500	65	K 50×55×30	–
	57	18	31,9	64	7,8	8 000	9 000	47	K 50×57×18	–
	58	20	34,1	62	7,65	8 000	9 000	75	K 50×58×20	G/SD 50×58×4
	58	25	41,8	81,5	10,2	8 000	9 000	90	K 50×58×25	G/SD 50×58×4
	52	12	17,2	36,5	4,3	8 000	9 000	24	K 52×57×12	–
55	60	20	27	67	8,15	7 500	8 500	40	K 55×60×20	–
	60	27	35,8	96,5	12	7 500	8 500	60	K 55×60×27	–
	60	30	39,6	108	13,4	7 500	8 500	71	K 55×60×30	–
	62	18	34,1	71	8,5	7 500	8 500	52	K 55×62×18	–
	63	20	38	75	9,15	7 500	8 500	67	K 55×63×20	G 55×63×5
	63	25	48,4	102	12,7	7 500	8 500	80	K 55×63×25	G 55×63×5
	63	32	59,4	129	16,3	7 500	8 500	100	K 55×63×32	G 55×63×5

¹⁾ For additional information, refer to the section *Radial shaft seals with a low cross sectional height*, starting on **page 208**.

Needle roller and cage assemblies

F_w 58 – 155 mm

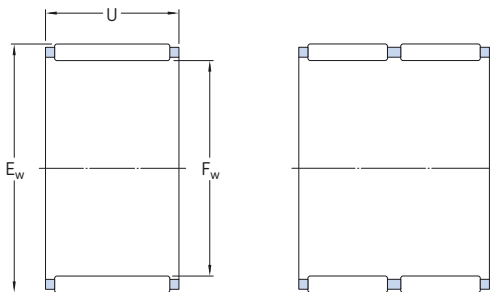

K

K..ZW

Dimensions			Basic load ratings		Fatigue load limit	Speed ratings		Mass	Designation	Appropriate seal ¹⁾ Designation
F_w	E_w	U	dynamic	static		Reference speed	Limiting speed			
mm			kN		kN	r/min		g	–	–
58	65	18	33,6	71	8,65	7 000	8 000	52	K 58×65×18	–
	65	36	47,3	108	12,9	7 000	8 000	130	K 58×65×36 ZW	–
60	65	20	28,1	72	8,8	7 000	8 000	52	K 60×65×20	–
	65	30	41,3	116	14,3	7 000	8 000	77	K 60×65×30	–
	66	33	44	112	13,7	7 000	8 000	100	K 60×66×33 ZW	–
	66	40	55	150	18,6	7 000	8 000	120	K 60×66×40 ZW	–
	68	20	41,8	86,5	10,6	6 700	7 500	71	K 60×68×20	–
	68	23	47,3	102	12,5	6 700	7 500	94	K 60×68×23	–
	68	25	51,2	112	14	6 700	7 500	89	K 60×68×25	–
	68	30	42,9	88	10,6	6 700	7 500	130	K 60×68×30 ZW	–
	75	42	112	196	25	6 300	7 500	240	K 60×75×42	–
62	70	40	62,7	146	18,6	6 700	7 500	170	K 62×70×40 ZW	–
64	70	16	26,4	60	7,35	6 300	7 500	53	K 64×70×16	–
65	70	20	29,2	76,5	9,3	6 300	7 500	56	K 65×70×20	–
	70	30	41,8	125	15,3	6 300	7 500	83	K 65×70×30	–
	73	23	41,8	90	11,8	6 300	7 000	110	K 65×73×23	–
	73	30	53,9	125	15,6	6 300	7 000	140	K 65×73×30	–
68	74	20	33,6	83	10,4	6 000	7 000	71	K 68×74×20	–
	74	30	44,6	118	15	6 000	7 000	100	K 68×74×30	–
	74	35	46,8	125	15,3	7 000	6 000	120	K 68×74×35 ZW	–
70	76	20	34,1	86,5	10,6	6 000	6 700	71	K 70×76×20	–
	76	30	50,1	140	17,6	6 000	6 700	110	K 70×76×30	–
	78	30	57,2	137	17	6 000	6 700	150	K 70×78×30	G 70×78×5
72	80	20	39,6	85	10,6	5 600	6 300	98	K 72×80×20	–
73	79	20	35,2	90	11,2	5 600	6 300	75	K 73×79×20	–
75	81	20	35,8	93	11,6	5 600	6 300	79	K 75×81×20	–
	81	30	50,1	143	18	5 600	6 300	110	K 75×81×30	–
	83	23	47,3	110	13,7	5 300	6 300	120	K 75×83×23	–
	83	30	59,4	143	18	5 300	6 300	150	K 75×83×30	–
	83	35	60,5	146	18	6 300	5 300	182	K 75×83×35 ZW	–
	83	40	69,3	176	22	6 300	5 300	211	K 75×83×40 ZW	–

¹⁾ For additional information, refer to the section *Radial shaft seals with a low cross sectional height*, starting on page 208.

Dimensions			Basic load ratings		Fatigue load limit P_u	Speed ratings		Mass g	Designation
F_w	E_w	U	dynamic C	static C_0		Reference speed	Limiting speed		
mm			kN		kN	r/min			-
80	86	20	36,9	98	12,2	5 300	6 000	60	K 80×86×20
	88	30	68,2	176	22	5 000	6 000	140	K 80×88×30
	88	40	72,1	193	23,6	6 000	5 000	227	K 80×88×40 ZW
	88	46	84,2	232	28,5	6 000	5 000	260	K 80×88×46 ZW
85	92	20	42,9	108	13,2	4 800	5 600	100	K 85×92×20
90	97	20	42,9	114	13,7	4 500	5 300	110	K 90×97×20
	98	27	58,3	150	18,6	4 500	5 300	150	K 90×98×27
	98	30	64,4	173	21,6	4 500	5 300	170	K 90×98×30
95	103	30	66	180	22,8	4 300	5 000	170	K 95×103×30
	103	40	79,2	228	28,5	5 000	4 300	266	K 95×103×40 ZW
100	107	21	45,7	127	15,3	4 000	4 800	120	K 100×107×21
	108	27	55	143	17,6	4 000	4 800	190	K 100×108×27
	108	30	67,1	190	23,6	4 000	4 800	180	K 100×108×30
105	112	21	45,7	129	15,3	4 000	4 500	130	K 105×112×21
110	117	24	53,9	160	18,6	3 800	4 300	170	K 110×117×24
	118	30	73,7	220	26,5	3 800	4 300	220	K 110×118×30
115	123	27	60,5	170	20	3 600	4 000	200	K 115×123×27
120	127	24	56,1	176	20,4	3 400	4 000	170	K 120×127×24
125	133	35	82,5	260	30,5	3 200	3 800	280	K 125×133×35
130	137	24	58,3	186	21,2	3 200	3 600	170	K 130×137×24
135	143	35	88	290	33,5	3 000	3 400	300	K 135×143×35
145	153	26	70,4	224	25	2 800	3 200	260	K 145×153×26
150	160	46	140	475	53	2 800	3 000	570	K 150×160×46
155	163	26	72,1	236	25,5	2 600	3 000	270	K 155×163×26

Needle roller and cage assemblies

F_w 160 – 265 mm

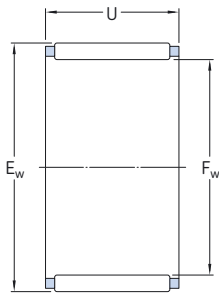

K

Dimensions			Basic load ratings		Fatigue load limit	Speed ratings		Mass	Designation
F_w	E_w	U	dynamic	static		Reference speed	Limiting speed		
			C	C_0	P_u				
mm			kN		kN	r/min		g	–
160	170	46	145	510	56	2 600	2 800	550	K 160×170×46
165	173	26	76,5	265	28,5	2 400	2 800	320	K 165×173×26
175	183	32	95,2	355	37,5	2 400	2 600	400	K 175×183×32
185	195	37	123	425	45	2 200	2 400	610	K 185×195×37
195	205	37	125	450	46,5	2 000	2 400	620	K 195×205×37
210	220	42	147	560	57	1 900	2 200	740	K 210×220×42
220	230	42	151	585	58,5	1 800	2 000	790	K 220×230×42
240	250	42	157	630	62	1 700	1 900	850	K 240×250×42
265	280	50	242	850	83	1 500	1 700	1 800	K 265×280×50



Drawn cup needle roller bearings

Sealed drawn cup needle roller bearings	78
Full complement drawn cup needle roller bearings	79
Dimensions.....	79
Tolerances	79
Misalignment.....	80
Cages	80
Shaft and housing tolerances	80
Operational clearance.....	80
Mounting instructions	81
Static safety factor	81
Supplementary designations.....	81
Product tables	82
3.1 Drawn cup needle roller bearings	82



Drawn cup needle roller bearings

Drawn cup needle roller bearings, as the name suggests, are needle roller bearings with a deep drawn, thin-walled outer ring with either open ends or a closed end. They are characterized by a very low sectional height and high load carrying capacity. Drawn cup needle roller bearings are typically used in applications where the housing bore cannot be used as a raceway for a needle roller and cage assembly, but where a very compact and economical bearing arrangement is required.

Generally, drawn cup needle roller bearings have a recommended maximum operating temperature of 140 °C, unless otherwise stated in the relevant sections in this chapter. The maximum operating temperature is limited by the seal and cage materials and the applied grease.

SKF supplies a wide assortment of drawn cup needle roller bearings. This includes:

- drawn cup needle roller bearings with open ends (→ **fig. 1**)
- drawn cup needle roller bearings with a closed end (→ **fig. 2**)
- full complement drawn cup needle roller bearings with open ends (→ **fig. 3**)

Drawn cup needle roller bearings with a closed end are suitable for bearing arrangements at the ends of shafts. The profiled design of the closed end accommodates small axial guidance forces. Drawn cup needle roller bearings generally run directly on the shaft. However, in cases where the shaft cannot be hardened and ground, they can be combined with an inner ring (→ **fig. 4**).

The drawn cup of hardened steel and the needle roller and cage assembly of these bearings form a non-separable unit. The space available for lubricant is large enough to enable long relubrication intervals.

Typically, drawn cup needle roller bearings have a single row of rollers. However, wide sizes incorporate two needle roller and cage assemblies immediately adjacent to each other with a lubrication hole in the outer ring (→ **fig. 5**).

On request, any single row drawn cup needle roller bearing for shaft diameters of 7 mm and above can be supplied with a lubrication hole in the outer ring (→ **fig. 6**).

Fig. 1

Drawn cup needle roller bearing with open ends

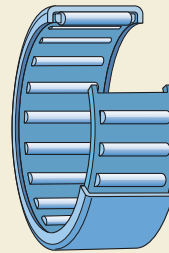

HK series

Fig. 2

Drawn cup needle roller bearing with a closed end

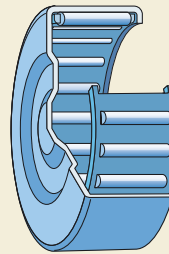

BK series

Fig. 3

Full complement drawn cup needle roller bearing with open ends

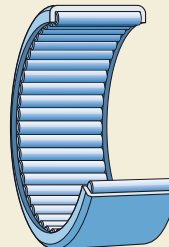

HN series

Fig. 4

Drawn cup needle roller bearing combined with an inner ring and an external seal

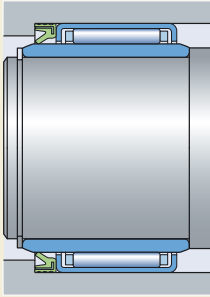

Fig. 7

Drawn cup needle roller bearing combined with a needle roller thrust bearing, AXW series

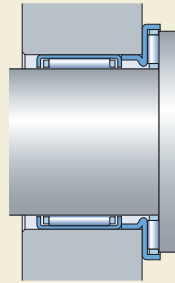

Fig. 5

Wide size drawn cup needle roller bearing, double row, with a lubrication hole

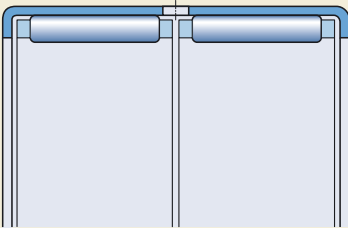
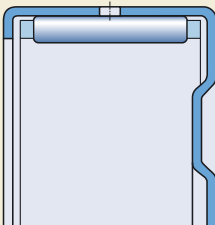

Fig. 6

Drawn cup needle roller bearing with a closed end and lubrication hole



Drawn cup needle roller bearings are mounted with an interference fit in the housing bore. Therefore, shoulders or snap rings are not required to locate the bearing axially so the design of the housing bore is simple and can be produced economically.

To accommodate combined radial and axial loads (→ **fig. 7**), drawn cup needle roller bearings of certain sizes can be combined with a needle roller thrust bearing with a centring spigot, AXW series.

Sealed drawn cup needle roller bearings

For applications where a sufficiently efficient seal is not available, or cannot be used for space reasons, drawn cup needle roller bearings can also be supplied with integral lip seals. These include:

- drawn cup needle roller bearings with open ends, sealed on one side, designation suffix RS (→ **fig. 8**), available for shaft diameters ranging from 8 mm to 50 mm
- drawn cup needle roller bearings with open ends, sealed on both sides, designation suffix .2RS (→ **fig. 9**), available for shaft diameters ranging from 8 mm to 50 mm
- sealed drawn cup needle roller bearings with a closed end, designation suffix RS (→ **fig. 10**), available for shaft diameters ranging from 10 mm to 25 mm

The integral seals are contact seals made of polyurethane (AU), fluoro rubber (FKM) or acrylonitrile-butadiene rubber (NBR). The use of a sealed drawn cup needle roller bearing is, under normal conditions, an extremely cost-effective solution to exclude solid contaminants and moisture and retain the lubricant in the bearing. The permissible operating temperature range for sealed bearings is -30 to $+100$ °C.

Initial grease fill and relubrication

Sealed drawn cup needle roller bearings are filled at the factory with a high-quality grease that has good corrosion inhibiting properties. The relatively large quantity of grease in the bearings means they can be operated for long periods before relubrication is required. SKF recommends using SKF LGWA 2 grease for relubrication.

For additional information about greases, refer to the section *Lubrication*, starting on **page 52** and **table 1** on **page 54**.

Fig. 8

Drawn cup needle roller bearing with open ends, sealed on one side

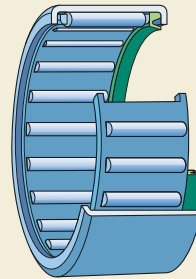

HK .. RS series

Fig. 9

Drawn cup needle roller bearing with open ends, sealed on both sides

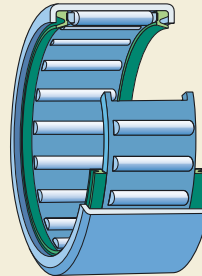

HK ...2RS series

Fig. 10

Sealed drawn cup needle roller bearing with a closed end

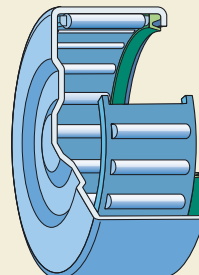

BK .. RS series

Full complement drawn cup needle roller bearings

Full complement drawn cup needle roller bearings with open ends (→ **fig. 3, page 76**) are suitable for very heavy radial loads at moderate speeds.

Initial grease fill and relubrication

A special grease is used to secure the rollers during transportation, however, this grease does not provide sufficient long term lubrication. Therefore, relubrication after mounting may be necessary. Depending on the required consistency class, SKF recommends SKF LGEP 2 or SKF LGMW 1 grease for relubrication. For additional information and characteristics (→ **table 2, page 54**) of the initial grease fill and the greases for relubrication, refer to the section *Lubrication*, starting on **page 52** or contact the SKF application engineering service.

Dimensions

The boundary dimensions of drawn cup needle roller bearings are in accordance with ISO 3245:2007, as far as they have been standardized.

Tolerances

The dimensional accuracy of drawn cup needle roller bearings cannot be checked until they have been mounted, because the thin-walled outer ring may be slightly out-of-round. Only after the bearing has been pressed into a housing bore that is machined to the recommended tolerance classes can the outer ring obtain its correct form, which is crucial for bearing performance. To check the inside diameter F_w of the roller set, the bearing must first be pressed into a thick-walled gauge ring with a bore diameter as listed in **table 1**. A measuring mandrel can then be used to check the inside diameter deviation. The permissible deviations are also listed in the table.

The tolerance values listed are in accordance with ISO 3245:2007, as far as they have been standardized.

Table 1

Tolerances for drawn cup needle roller bearings

Bearing Inside diameter F_w	Outside diameter D	Gauge ring Bore diameter (measured)	Deviations from nominal inside diameter	
			high	low
mm		mm	µm	
3	6,5	6,484	+24	+6
4	8	7,984	+28	+10
5	9	8,984	+28	+10
6	10	9,984	+28	+10
7	11	10,980	+31	+13
8	12	11,980	+31	+13
9	13	12,980	+31	+13
10	14	13,980	+31	+13
12	16	15,980	+34	+16
12	18	17,980	+34	+16
13	19	18,976	+34	+16
14	20	19,976	+34	+16
15	21	20,976	+34	+16
16	22	21,976	+34	+16
17	23	22,976	+34	+16
18	24	23,976	+34	+16
20	26	25,976	+41	+20
22	28	27,976	+41	+20
25	32	31,972	+41	+20
28	35	34,972	+41	+20
30	37	36,972	+41	+20
32	39	38,972	+50	+25
35	42	41,972	+50	+25
40	47	46,972	+50	+25
45	52	51,967	+50	+25
50	58	57,967	+50	+25
55	63	62,967	+60	+30
60	68	67,967	+60	+30

The width tolerance is 0/−0,3 mm for all drawn cup needle roller bearing sizes.

Paired mounting

If drawn cup needle roller bearings are to be mounted immediately adjacent to each other, the deviations from the nominal internal diameter must be the same for both bearings if they are to share the load equally.

Misalignment

The ends of the needle rollers are relieved slightly to modify the line contact between the raceways and the rollers. This provides favourable load distribution in the bearing and minimizes damaging edge stresses. It also enables single row drawn cup needle roller bearings to accommodate a small amount of misalignment, approximately 1 min of arc between the shaft and housing.

The detrimental effects of misalignment increase with increasing bearing width and load. For additional information, contact the SKF application engineering service.

Cages

SKF drawn cup needle roller bearings are fitted, as standard, with a sheet steel cage (→ **fig. 11**), except for those identified by the designation suffix TN. These have an injection moulded, glass fibre reinforced polyamide 66 cage (→ **fig. 12**).

Note

Drawn cup needle roller bearings with a polyamide 66 cage can be operated at temperatures up to +120 °C. The lubricants generally used for rolling bearings do not have a detrimental effect on cage properties. Exceptions are a few synthetic oils and greases with a synthetic oil base and lubricants containing a high proportion of EP additives when used at high temperatures.

For bearing arrangements that will operate at continuously high temperatures or under arduous conditions, SKF recommends using bearings with a steel cage.

For detailed information about the temperature resistance and the applicability of cages, refer to the section *Cage materials*, starting on **page 44**.

Shaft and housing tolerances

Drawn cup needle roller bearings need a housing bore that has a good dimensional form and accuracy. For these bearings, to obtain the necessary interference fit in the housing, the tolerance classes listed in **table 2** must be

Fig. 11

Sheet steel cage

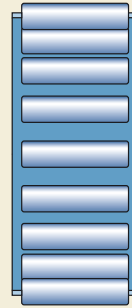
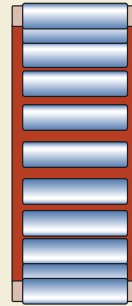

Fig. 12

Polyamide 66 cage



applied. The cylindricity of the housing bore should be within IT5/2 tolerance grade and the shaft raceway should be within IT3 tolerance grade.

Operational clearance

When the recommended tolerance classes are applied, the inside diameter F_w (diameter under the rollers) will be approximately within F8 tolerance class. This, together with the recommended shaft tolerance class, which is also listed in **table 2**, will reach a suitable (medium) operational clearance in the range of C2 to C3 radial internal clearance. The clearance value depends on the shaft diameter, the operating

temperature, and on the raceway diameter when combined with an inner ring.

Mounting instructions

Drawn cup needle roller bearings should be mounted with a heavy interference fit in the housing bore. Therefore, SKF recommends mounting them using a mounting dolly (→ fig. 13). An O-ring provides a simple means of retaining the bearing on the mounting dolly. The stamped side face of drawn cup needle roller bearings should preferably abut the flange of the mounting dolly.

If grease lubrication is going to be used, the bearing should be lubricated before mounting.

Note

Special care should be taken to prevent the bearings from skewing or tilting when they are being pressed into the housing. Otherwise the rollers and raceways could easily be damaged.

Static safety factor

SKF recommends applying a static safety factor of 3 or larger, i.e. $s_0 = C_0/P_0 \geq 3$.

Supplementary designations

The designation suffixes used to identify certain features of SKF drawn cup needle roller bearings are explained in the following.

- AS1** One lubrication hole in the outer ring
- H..** Needle roller bearing without an inner ring, with reduced inside diameter (under rollers) tolerance, followed by tolerance limits in μm , e.g. H+27+20
- RS** Contact seal on one side of the bearing
- .2RS** Contact seal on both sides of a drawn cup needle roller bearing with open ends
- TN** Injection moulded cage of glass fibre reinforced polyamide 66

Table 2

Shaft and housing tolerance classes

Housing material ¹⁾	Tolerance classes		
	Housing bore seat ²⁾	Raceway on the shaft	Shaft inner ring seat
Steel, cast iron	N6 N7	h5 h6	k5 j6
Light alloy	R6 R7	h5 h6	k5 j6

¹⁾ For housings that are not rigid, the shaft tolerance giving the desired operational clearance must be determined by trial and error.

²⁾ The accuracy of cylindrical form to ISO 1101-2004 for the housing bore must correspond to IT5/2 tolerance grade.

Fig. 13

Mounting dolly

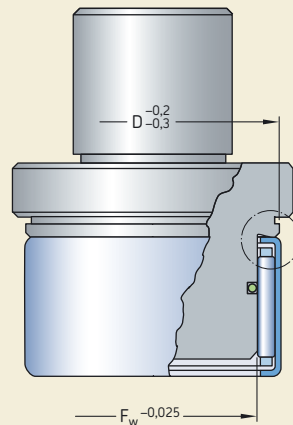

Drawn cup needle roller bearings

F_w 3 – 9 mm

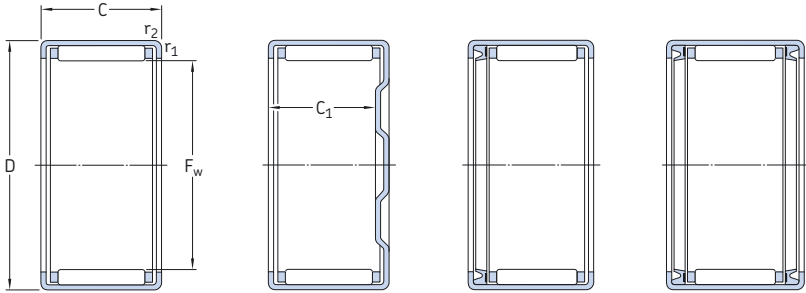

HK

BK

HK..RS

HK...2RS

Principal dimensions			Basic load ratings		Fatigue load limit	Speed ratings		Mass	Designation
F_w	D	C	C	C_0	P_u	Reference speed	Limiting speed		
mm			kN		kN	r/min		kg	–
3	6,5	6	1,23	0,88	0,088	24 000	26 000	0,0010	HK 0306 TN
	6,5	6	1,23	0,88	0,088	24 000	26 000	0,0010	BK 0306 TN
4	8	8	1,76	1,37	0,14	22 000	26 000	0,0020	HK 0408
	8	8	1,76	1,37	0,14	22 000	26 000	0,0021	BK 0408
5	9	9	2,38	2,08	0,22	22 000	24 000	0,0020	HK 0509
	9	9	2,38	2,08	0,22	22 000	24 000	0,0021	BK 0509
6	10	6	1,72	1,29	0,132	22 000	20 000	0,0015	HK 0606
	10	8	2,01	1,73	0,18	20 000	22 000	0,0021	HK 0608
	10	9	2,81	2,7	0,285	20 000	22 000	0,0025	HK 0609
	10	9	2,81	2,7	0,285	20 000	22 000	0,0026	BK 0609
7	11	9	3,03	3,05	0,325	20 000	22 000	0,0026	HK 0709
	11	9	3,03	3,05	0,325	20 000	22 000	0,0029	BK 0709
8	12	8	2,7	2,75	0,285	19 000	22 000	0,0027	HK 0808
	12	8	2,7	2,75	0,285	19 000	22 000	0,0030	BK 0808
	12	10	3,69	4,05	0,44	19 000	22 000	0,0030	HK 0810
	12	10	2,7	2,75	0,285	19 000	13 000	0,0030	HK 0810 RS
	12	10	2,3	2,04	0,208	13 000	19 000	0,0032	HK 0810.2RS
	12	10	3,69	4,05	0,44	19 000	22 000	0,0034	BK 0810
	12	12	3,69	4,05	0,44	13 000	19 000	0,0031	HK 0812 RS
	12	12	2,7	2,75	0,285	–	13 000	0,0033	HK 0812.2RS
9	13	8	3,52	3,9	0,415	20 000	20 000	0,0030	HK 0908
	13	10	4,13	4,8	0,53	18 000	20 000	0,0040	HK 0910
	13	10	4,13	4,8	0,53	18 000	20 000	0,0043	BK 0910
	13	12	5,12	6,4	0,72	18 000	20 000	0,0046	HK 0912
	13	12	5,12	6,4	0,72	18 000	20 000	0,0049	BK 0912

Dimensions			Appropriate inner ring ¹⁾ Designation	Appropriate seal ²⁾ Designation
F _w	C ₁ min	r _{1,2} min		
mm				
3	–	0,3	–	–
	5,2	0,3	–	–
4	–	0,3	–	G 4×8×2 S
	6,4	0,3	–	G 4×8×2 S
5	–	0,4	–	G 5×9×2 S
	7,2	0,4	–	G 5×9×2 S
6	–	0,4	–	G 6×10×2 S
	–	0,4	–	G 6×10×2 S
	–	0,4	–	G 6×10×2 S
	7,4	0,4	–	G 6×10×2 S
7	–	0,4	–	G 7×11×2 S
	7,4	0,4	–	G 7×11×2 S
8	–	0,4	–	G 8×12×3
	6,4	0,4	–	G 8×12×3
	–	0,4	IR 5×8×12	G 8×12×3
	–	0,4	IR 5×8×12	–
	–	0,4	–	–
	8,4	0,4	IR 5×8×12	G 8×12×3
	–	0,4	–	–
	–	0,4	IR 5×8×16	–
9	–	0,4	–	G 9×13×3
	–	0,4	IR 6×9×12	G 9×13×3
	8,2	0,4	IR 6×9×12	G 9×13×3
	–	0,4	IR 6×9×12	G 9×13×3
	–	0,4	IR 6×9×12	G 9×13×3
	10,4	0,4	IR 6×9×12	G 9×13×3

¹⁾ For additional information, refer to the section *Needle roller bearing inner rings*, starting on **page 196**.

²⁾ For additional information, refer to the section *Radial shaft seals with a low cross sectional height*, starting on **page 208**.

Drawn cup needle roller bearings

F_w 10 – 14 mm

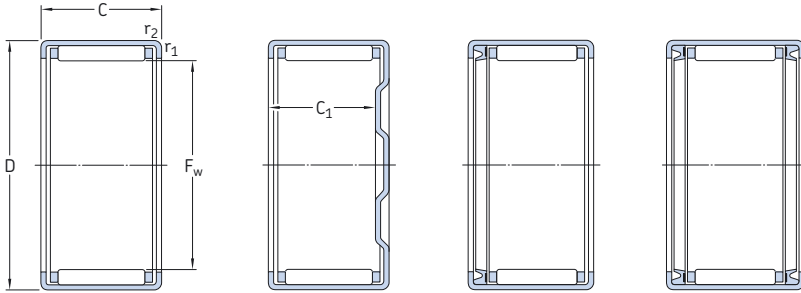

HK

BK

HK..RS

HK...2RS

Principal dimensions			Basic load ratings		Fatigue load limit	Speed ratings		Mass	Designation	
F _w	D	C	C	C ₀	P _u	Reference speed	Limiting speed			
mm			kN		kN	r/min		kg	–	
10	14	10	4,29	5,3	0,57	18 000	20 000	0,0041	HK 1010	
	14	10	6,82	11,4	1,27	18 000	14 000	0,0046	HN 1010	
	14	10	4,29	5,3	0,57	18 000	20 000	0,0043	BK 1010	
	14	12	5,39	6,95	0,78	18 000	20 000	0,0048	HK 1012	
	14	12	4,29	5,3	0,57	18 000	12 000	0,0042	HK 1012 RS	
	14	12	3,19	3,55	0,365	12 000	18 000	0,0043	HK 1012.2RS	
	14	12	5,39	6,95	0,78	18 000	20 000	0,0050	BK 1012	
	14	12	4,29	5,3	0,57	12 000	18 000	0,0043	BK 1012 RS	
	14	14	4,29	5,3	0,57	–	12 000	0,0046	HK 1014.2RS	
	14	15	6,6	9	1,02	18 000	20 000	0,0060	HK 1015	
	14	15	6,6	9	1,02	18 000	20 000	0,0062	BK 1015	
	12	16	10	4,84	6,4	0,71	16 000	18 000	0,0046	HK 1210
		16	10	7,48	13,7	1,53	17 000	13 000	0,0053	HN 1210
		16	10	4,84	6,4	0,71	16 000	18 000	0,0052	BK 1210
18		12	6,27	7,35	0,85	16 000	18 000	0,0090	HK 1212	
18		12	9,52	15,3	1,76	17 000	13 000	0,011	HN 1212	
18		12	6,27	7,35	0,85	16 000	18 000	0,010	BK 1212	
18		14	6,27	7,35	0,85	16 000	10 000	0,010	HK 1214 RS	
16		14	4,84	6,4	0,71	10 000	16 000	0,0080	HK 1214.2RS	
18		16	6,27	7,35	0,85	–	10 000	0,011	HK 1216.2RS	
13		19	12	6,6	8	0,915	16 000	17 000	0,010	HK 1312
	19	12	6,6	8	0,915	16 000	17 000	0,011	BK 1312	
14	20	12	6,82	8,65	0,98	15 000	17 000	0,011	HK 1412	
	20	12	10,5	17,6	2,04	15 000	12 000	0,012	HN 1412	
	20	12	6,82	8,65	0,98	15 000	17 000	0,012	BK 1412	
	20	14	6,82	8,65	0,98	15 000	9 500	0,012	HK 1414 RS	
	20	14	6,82	8,65	0,98	15 000	9 500	0,013	BK 1414 RS	
	20	16	6,82	8,65	0,98	–	9 500	0,013	HK 1416.2RS	

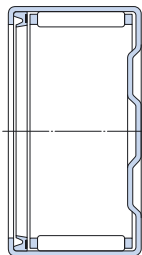

BK..RS

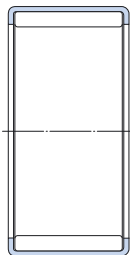

HN

Dimensions			Appropriate inner ring ¹⁾ Designation	Appropriate seal ²⁾ Designation
F _w	C ₁ min	r _{1,2} min		
mm				
10	–	0,4	LR/IR 7×10×10,5	G 10×14×3
	–	0,4	LR/IR 7×10×10,5	G 10×14×3
	8,4	0,4	LR/IR 7×10×10,5	G 10×14×3
	–	0,4	IR 7×10×12	G 10×14×3
	–	0,4	IR 7×10×12	–
	–	0,4	–	–
	10,4	0,4	IR 7×10×12	G 10×14×3
	10,4	0,4	–	–
	–	0,4	IR 7×10×16	–
	–	0,4	IR 7×10×16	G 10×14×3
13,4	0,4	IR 7×10×16	G 10×14×3	
12	–	0,4	LR/IR 8×12×10,5	G 12×16×3
	–	0,4	LR/IR 8×12×10,5	G 12×16×3
	8,4	0,4	LR/IR 8×12×10,5	G 12×16×3
	–	0,8	LR/IR 8×12×12,5	G/SD 12×18×3
	–	0,8	LR/IR 8×12×12,5	G/SD 12×18×3
	9,3	0,8	LR/IR 8×12×12,5	G/SD 12×18×3
	–	0,8	–	–
	–	0,8	–	–
–	0,8	IR 9×12×16	–	
13	–	0,8	LR/IR 10×13×12,5	G 13×19×3
	9,3	0,8	LR/IR 10×13×12,5	G 13×19×3
14	–	0,8	IR 10×14×13	G/SD 14×20×3
	–	0,8	IR 10×14×13	G/SD 14×20×3
	9,3	0,8	IR 10×14×13	G/SD 14×20×3
	–	0,8	IR 10×14×16	–
	11,3	0,8	IR 10×14×13	–
	–	0,8	IR 10×14×20	–

¹⁾ For additional information, refer to the section *Needle roller bearing inner rings*, starting on page 196.

²⁾ For additional information, refer to the section *Radial shaft seals with a low cross sectional height*, starting on page 208.

Drawn cup needle roller bearings

F_w 15 – 18 mm

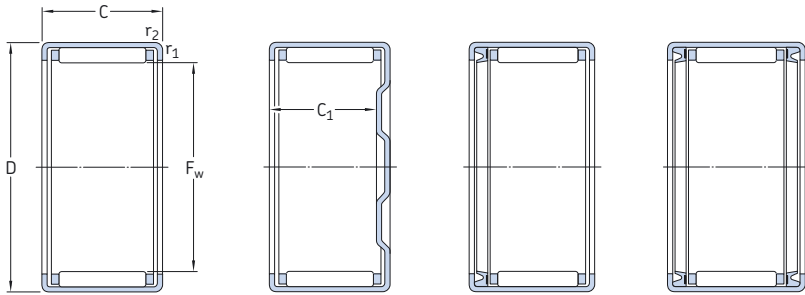

HK

BK

HK..RS

HK...2RS

Principal dimensions	Basic load ratings		Fatigue load limit	Speed ratings		Mass	Designation	
	dynamic	static		Reference speed	Limiting speed			
F _w D C	C	C ₀	P _u					
mm	kN		kN	r/min		kg	–	
15	21 12	7,65	9,5	1,08	15 000	16 000	0,011	HK 1512
	21 12	7,65	9,5	1,08	15 000	16 000	0,013	BK 1512
	21 14	7,48	10	1,14	15 000	9 500	0,012	HK 1514 RS
	21 16	10,1	14,6	1,7	15 000	16 000	0,015	HK 1516
	21 16	7,48	10	1,14	–	9 500	0,015	HK 1516.2RS
	21 16	14,5	28	3,25	15 000	12 000	0,014	HN 1516
	21 16	10,1	14,6	1,7	15 000	16 000	0,017	BK 1516
	21 18	10,1	14,6	1,7	15 000	9 500	0,016	HK 1518 RS
	21 20	10,1	14,6	1,7	–	9 500	0,018	HK 1520.2RS
	21 22	13	20	2,28	15 000	16 000	0,020	HK 1522¹⁾
	16	22 12	7,37	9,8	1,12	14 000	16 000	0,012
22 12		11,2	20,4	2,32	15 000	12 000	0,013	HN 1612
22 12		7,37	9,8	1,12	14 000	16 000	0,014	BK 1612
22 14		7,37	9,8	1,12	14 000	9 000	0,013	HK 1614 RS
22 14		7,37	9,8	1,12	14 000	9 000	0,015	BK 1614 RS
22 16		10,5	15,6	1,8	14 000	16 000	0,016	HK 1616
22 16		7,37	9,8	1,12	–	9 000	0,014	HK 1616.2RS
22 16		10,5	15,6	1,8	14 000	16 000	0,018	BK 1616
22 20		11	14,6	1,66	–	9 000	0,018	HK 1620.2RS
22 22		12,8	19,6	2,24	14 000	16 000	0,022	HK 1622¹⁾
22 22		12,8	19,6	2,24	14 000	16 000	0,024	BK 1622¹⁾
17	23 12	7,65	10,6	1,2	14 000	15 000	0,012	HK 1712
18	24 12	7,92	11,2	1,27	13 000	15 000	0,013	HK 1812
	24 12	7,92	11,2	1,27	13 000	15 000	0,015	BK 1812
	24 14	7,92	11,2	1,27	13 000	8 500	0,014	HK 1814 RS
	24 16	11,2	17,6	2,04	13 000	15 000	0,018	HK 1816
	24 16	7,92	11,2	1,27	–	8 500	0,015	HK 1816.2RS
	24 16	16,1	33,5	3,8	14 000	11 000	0,020	HN 1816
	24 16	11,2	17,6	2,04	13 000	15 000	0,020	BK 1816

¹⁾ Double row, outer ring with a lubrication hole

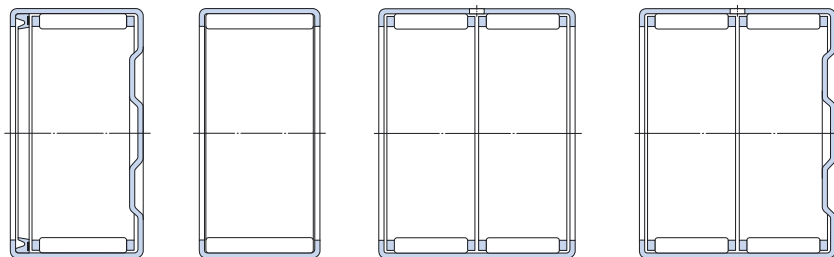

BK..RS

HN

HK
(double row)BK
(double row)**Dimensions**
 F_w C_1
min min

 $r_{1,2}$
min
**Appropriate
inner ring¹⁾**

Designation

**Appropriate
seal²⁾**

Designation

mm

15	–	0,8	LR/IR 12×15×12.5	G/SD 15×21×3
	9,3	0,8	LR/IR 12×15×12.5	G/SD 15×21×3
	–	0,8	LR/IR 12×15×16.5	–
	–	0,8	LR/IR 12×15×16.5	G/SD 15×21×3
	–	0,8	LR/IR 12×15×16.5	–
	–	0,8	LR/IR 12×15×16.5	G/SD 15×21×3
	13,3	0,8	LR/IR 12×15×16.5	G/SD 15×21×3
	–	0,8	–	–
	–	0,8	LR/IR 12×15×22.5	–
	–	0,8	LR/IR 12×15×22.5	G/SD 15×21×3
16	–	0,8	IR 12×16×13	G/SD 16×22×3
	–	0,8	IR 12×16×13	G/SD 16×22×3
	9,3	0,8	IR 12×16×13	G/SD 16×22×3
	–	0,8	IR 12×16×16	–
	11,3	0,8	IR 12×16×13	–
	–	0,8	IR 12×16×16	G/SD 16×22×3
	–	0,8	IR 12×16×20	–
	13,3	0,8	IR 12×16×16	G/SD 16×22×3
	–	0,8	IR 12×16×22	–
	–	0,8	IR 12×16×22	G/SD 16×22×3
19,3	0,8	IR 12×16×22	G/SD 16×22×3	
17	–	0,8	–	G/SD 17×23×3
	–	0,8	–	–
18	–	0,8	LR 15×18×12.5	G/SD 18×24×3
	9,3	0,8	LR 15×18×12.5	G/SD 18×24×3
	–	0,8	LR/IR 15×18×16.5	–
	–	0,8	LR/IR 15×18×16.5	G/SD 18×24×3
	–	0,8	LR/IR 15×18×16.5	–
	–	0,8	LR/IR 15×18×16.5	G/SD 18×24×3
	–	0,8	LR/IR 15×18×16.5	–
	13,3	0,8	LR/IR 15×18×16.5	G/SD 18×24×3

¹⁾ For additional information, refer to the section *Needle roller bearing inner rings*, starting on **page 196**.

²⁾ For additional information, refer to the section *Radial shaft seals with a low cross sectional height*, starting on **page 208**.

Drawn cup needle roller bearings

F_w 20 – 22 mm

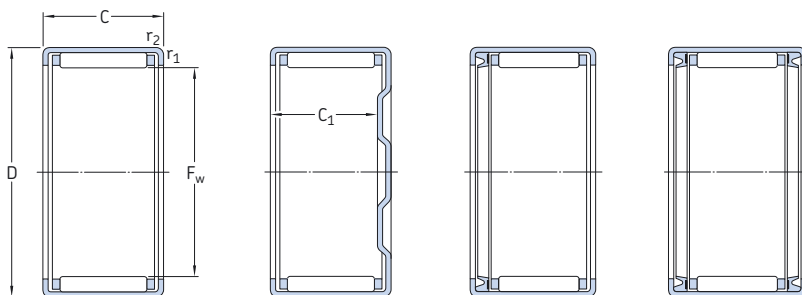

HK

BK

HK..RS

HK...2RS

Principal dimensions	Basic load ratings		Fatigue load limit	Speed ratings		Mass	Designation		
	dynamic	static		Reference speed	Limiting speed				
F_w	D	C	C	C_0	P_u				
mm			kN		kN	r/min	kg	–	
20	26	10	6,16	8,5	0,93	12 000	14 000	0,012	HK 2010
	26	12	8,42	12,5	1,4	12 000	14 000	0,014	HK 2012
	26	16	12,3	20,4	2,36	12 000	14 000	0,019	HK 2016
	26	16	8,42	12,5	1,4	–	8 000	0,018	HK 2016.2RS
	26	16	16,8	36,5	4,25	12 000	10 000	0,022	HN 2016
	26	16	12,3	20,4	2,36	12 000	14 000	0,022	BK 2016
	26	18	12,3	20,4	2,36	12 000	8 000	0,021	HK 2018 RS
	26	18	12,3	20,4	2,36	12 000	8 000	0,024	BK 2018 RS
	26	20	15,1	26,5	3,15	12 000	14 000	0,024	HK 2020
	26	20	12,3	20,4	2,36	–	8 000	0,023	HK 2020.2RS
	26	20	20,9	48	5,7	12 000	10 000	0,030	HN 2020
	26	20	15,1	26,5	3,15	12 000	14 000	0,027	BK 2020 ¹⁾
	26	30	20,9	40,5	4,75	12 000	14 000	0,035	HK 2030 ¹⁾
	22	28	10	7,21	10,6	1,2	11 000	12 000	0,013
28		12	8,8	13,7	1,56	11 000	12 000	0,015	HK 2212
28		12	8,8	13,7	1,56	11 000	12 000	0,018	BK 2212
28		14	8,8	13,7	1,56	11 000	7 500	0,016	HK 2214 RS
28		16	13	22,4	2,6	11 000	12 000	0,021	HK 2216
28		16	8,8	13,7	1,56	–	7 500	0,018	HK 2216.2RS
28		16	13	22,4	2,6	11 000	12 000	0,024	BK 2216
28		18	13	22,4	2,6	11 000	7 500	0,024	HK 2218 RS
28		20	15,7	29	3,45	11 000	12 000	0,026	HK 2220
28		20	13	22,4	2,6	–	7 500	0,026	HK 2220.2RS

¹⁾ Double row, outer ring with a lubrication hole

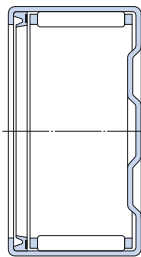

BK..RS

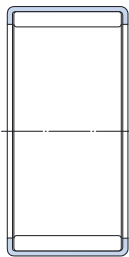

HN

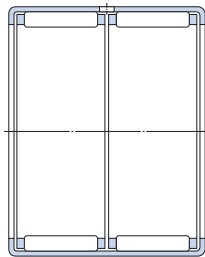
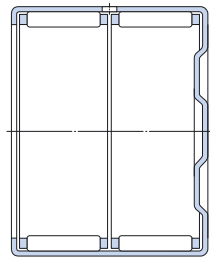
HK
(double row)BK
(double row)**Dimensions**

F_w C_1
min min

$r_{1,2}$
min

**Appropriate
inner ring¹⁾**
Designation

**Appropriate
seal²⁾**
Designation

mm

20	–	0,8	IR 15×20×12 IS1	G/SD 20×26×4
	–	0,8	IR 15×20×13	G/SD 20×26×4
	–	0,8	LR/IR 17×20×16.5	G/SD 20×26×4
	–	0,8	LR/IR 17×20×16.5	–
	–	0,8	LR/IR 17×20×16.5	G/SD 20×26×4
	13,3	0,8	LR/IR 17×20×16.5	G/SD 20×26×4
	–	0,8	LR/IR 17×20×20.5	–
	15,3	0,8	LR/IR 17×20×16.5	–
	–	0,8	LR/IR 17×20×20.5	G/SD 20×26×4
	–	0,8	LR/IR 17×20×20.5	–
	–	0,8	LR/IR 17×20×20.5	G/SD 20×26×4
	17,3	0,8	LR/IR 17×20×20.5	G/SD 20×26×4
	–	0,8	LR/IR 17×20×30.5	G/SD 20×26×4
22	–	0,8	IR 17×22×13	G/SD 22×28×4
	–	0,8	IR 17×22×13	G/SD 22×28×4
	9,3	0,8	IR 17×22×13	G/SD 22×28×4
	–	0,8	IR 17×22×16	–
	–	0,8	IR 17×22×16	G/SD 22×28×4
	–	0,8	IR 17×22×23	–
	13,3	0,8	IR 17×22×16	G/SD 22×28×4
	–	0,8	IR 17×22×23	–
	–	0,8	IR 17×22×23	G/SD 22×28×4
	–	0,8	IR 17×22×23	–
	–	0,8	IR 17×22×23	–

¹⁾ For additional information, refer to the section *Needle roller bearing inner rings*, starting on **page 196**.

²⁾ For additional information, refer to the section *Radial shaft seals with a low cross sectional height*, starting on **page 208**.

Drawn cup needle roller bearings

F_w 25 – 30 mm

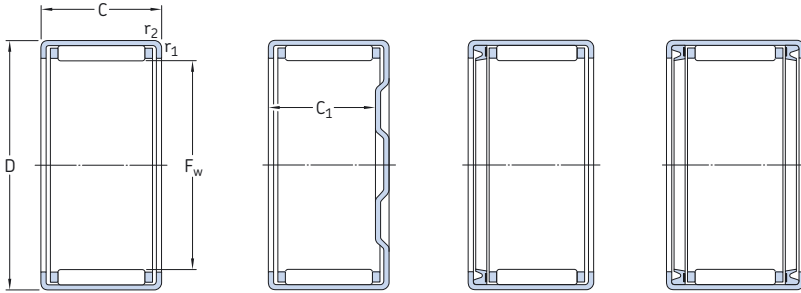

HK

BK

HK..RS

HK...2RS

Principal dimensions			Basic load ratings		Fatigue load limit	Speed ratings		Mass	Designation	
F _w	D	C	C	C ₀	P _u	Reference speed	Limiting speed			
mm			kN		kN	r/min		kg	–	
25	32	12	10,5	15,3	1,76	9 500	11 000	0,020	HK 2512	
	32	16	15,1	24	2,85	9 500	11 000	0,027	HK 2516	
	32	16	10,5	15,3	1,76	–	6 700	0,027	HK 2516.2RS	
	32	16	15,1	24	2,85	11 000	9 500	0,032	BK 2516	
	32	18	15,1	24	2,85	9 500	6 700	0,029	HK 2518 RS	
	32	18	15,1	24	2,85	9 500	6 700	0,034	BK 2518 RS	
	32	20	19	32,5	4	9 500	11 000	0,033	HK 2520	
	32	20	15,1	24	2,85	–	6 700	0,031	HK 2520.2RS	
	32	20	26,4	60	7,2	10 000	8 000	0,040	HN 2520	
	32	20	19	32,5	4	9 500	11 000	0,038	BK 2520	
	32	24	19	32,5	4	–	6 700	0,040	HK 2524.2RS	
	32	26	24,2	45	5,5	9 500	11 000	0,044	HK 2526	
	32	26	24,2	45	5,5	9 500	11 000	0,048	BK 2526	
	32	30	24,2	45	5,5	–	6 700	0,047	HK 2530.2RS	
	32	38	33	65,5	8	9 500	11 000	0,064	HK 2538¹⁾	
	32	38	33	65,5	8	9 500	11 000	0,068	BK 2538¹⁾	
	28	35	16	15,7	26,5	3,15	9 000	9 500	0,029	HK 2816
		35	18	15,7	26,5	3,15	6 300	9 000	0,031	HK 2818 RS
		35	20	20,1	36,5	4,4	9 000	9 500	0,036	HK 2820
		35	20	15,7	26,5	3,15	–	6 300	0,034	HK 2820.2RS
35		20	28,1	68	8,15	9 000	7 000	0,044	HN 2820	
30		37	12	11,7	18,3	2,12	8 000	9 000	0,023	HK 3012
	37	12	11,7	18,3	2,12	8 000	9 000	0,028	BK 3012	
	37	16	16,5	29	3,4	8 000	9 000	0,031	HK 3016	
	37	16	11,7	18,3	2,12	–	5 600	0,031	HK 3016.2RS	
	37	16	16,5	29	3,4	8 000	9 000	0,038	BK 3016	
	37	18	16,5	29	3,4	8 000	5 600	0,037	HK 3018 RS	
	37	20	20,9	40	4,75	8 000	9 000	0,039	HK 3020	
	37	20	16,5	29	3,4	–	5 600	0,036	HK 3020.2RS	
	37	20	20,9	40	4,75	8 000	9 000	0,047	BK 3020	
	37	22	23,8	46,5	5,6	9 000	8 000	0,042	HK 3022	
	37	24	20,9	40	4,75	–	5 600	0,044	HK 3024.2RS	
	37	26	27	54	6,55	8 000	9 000	0,051	HK 3026	
	37	26	27	54	6,55	8 000	9 000	0,058	BK 3026	
	37	38	35,8	80	9,5	8 000	9 000	0,076	HK 3038¹⁾	
	37	38	35,8	80	9,5	8 000	9 000	0,084	BK 3038¹⁾	

¹⁾ Double row, outer ring with a lubrication hole

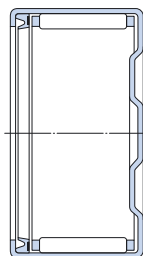

BK..RS

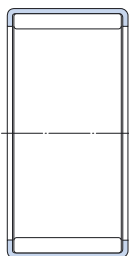

HN

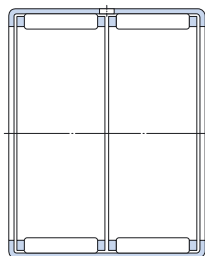
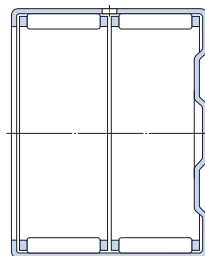
HK
(double row)BK
(double row)**Dimensions**

F_w C_1
min min

$r_{1,2}$
min

**Appropriate
inner ring¹⁾**
Designation

**Appropriate
seal²⁾**
Designation

mm

25	–	0,8	LR 20×25×12.5	G 25×32×4
	–	0,8	LR 20×25×16.5 / IR 20×25×17	G 25×32×4
	–	0,8	LR 20×25×16.5 / IR 20×25×17	–
	23,3	0,8	–	–
	–	0,8	LR/IR 20×25×20.5	–
	15,3	0,8	LR 20×25×16.5 / IR 20×25×17	–
	–	0,8	LR/IR 20×25×20.5	G 25×32×4
	–	0,8	LR/IR 20×25×20.5	–
	–	0,8	LR/IR 20×25×20.5	G 25×32×4
	17,3	0,8	LR/IR 20×25×20.5	G 25×32×4
	–	0,8	LR/IR 20×25×26.5	–
	–	0,8	LR/IR 20×25×26.5	G 25×32×4
	23,3	0,8	LR/IR 20×25×26.5	G 25×32×4
	–	0,8	IR 20×25×30	–
	–	0,8	LR/IR 20×25×38.5	G 25×32×4
35,3	0,8	LR/IR 20×25×38.5	G 25×32×4	
28	–	0,8	IR 22×28×17	G/SD 28×35×4
	–	0,8	LR/IR 22×28×20.5	–
	–	0,8	LR/IR 22×28×20.5	G/SD 28×35×4
	–	0,8	LR/IR 22×28×20.5	–
	–	0,8	LR/IR 22×28×20.5	G/SD 28×35×4
30	–	0,8	LR 25×30×12.5	G/SD 30×37×4
	–	0,8	LR 25×30×12.5	G/SD 30×37×4
	–	0,8	LR 25×30×16.5 / IR 25×30×17	G/SD 30×37×4
	–	0,8	LR 25×30×16.5 / IR 25×30×17	–
	13,3	0,8	LR 25×30×16.5 / IR 25×30×17	G/SD 30×37×4
	–	0,8	LR/IR 25×30×20.5	–
	–	0,8	LR/IR 25×30×20.5	G/SD 30×37×4
	–	0,8	LR/IR 25×30×20.5	–
	17,3	0,8	LR/IR 25×30×20.5	G/SD 30×37×4
	–	0,8	–	G/SD 30×37×4
	–	0,8	LR/IR 25×30×26.5	–
	–	0,8	LR/IR 25×30×26.5	G/SD 30×37×4
	23,3	0,8	LR/IR 25×30×26.5	G/SD 30×37×4
–	0,8	LR/IR 25×30×38.5	G/SD 30×37×4	
35,3	0,8	LR/IR 25×30×38.5	G/SD 30×37×4	

¹⁾ For additional information, refer to the section *Needle roller bearing inner rings*, starting on **page 196**.

²⁾ For additional information, refer to the section *Radial shaft seals with a low cross sectional height*, starting on **page 208**.

Drawn cup needle roller bearings

F_w 32 – 50 mm

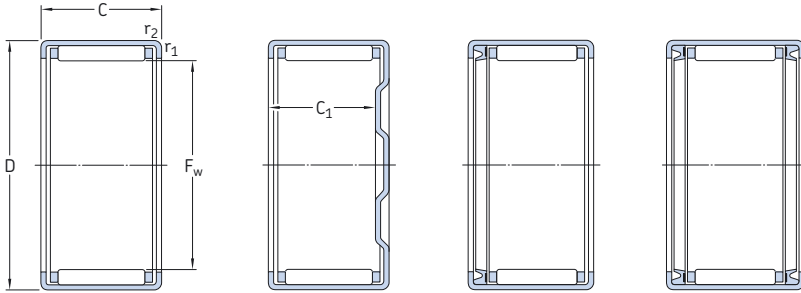

HK

BK

HK..RS

HK...2RS

Principal dimensions	Basic load ratings		Fatigue load limit	Speed ratings		Mass	Designation		
	dynamic	static		Reference speed	Limiting speed				
F _w D C	C	C ₀	P _u						
mm	kN		kN	r/min		kg	–		
32	39	20	22	43	5,2	8 500	7 500	0,041	HK 3220
	39	24	26,4	54	6,55	8 500	7 500	0,049	HK 3224
35	42	12	12,5	21,6	2,45	7 000	8 000	0,027	HK 3512
	42	16	17,9	34	4	7 000	8 000	0,036	HK 3516
	42	16	12,5	21,6	2,45	–	5 000	0,032	HK 3516.2RS
	42	18	17,9	34	4	7 000	5 000	0,039	HK 3518 RS
	42	20	22,9	46,5	5,6	7 000	8 000	0,044	HK 3520
	42	20	17,9	34	4	–	5 000	0,041	HK 3520.2RS
	42	20	31,4	83	10,2	7 500	6 000	0,054	HN 3520
	42	20	22,9	46,5	5,6	7 000	8 000	0,053	BK 3520
40	47	12	13,4	24,5	2,8	6 300	7 000	0,030	HK 4012
	47	16	19	39	4,55	6 300	7 000	0,039	HK 4016
	47	16	13,4	24,5	2,8	–	4 500	0,037	HK 4016.2RS
	47	18	19	39	4,55	6 300	4 500	0,045	HK 4018 RS
	47	20	24,2	53	6,4	6 300	7 000	0,054	HK 4020
	47	20	19	39	4,55	–	4 500	0,048	HK 4020.2RS
	47	20	33,6	95	11,6	6 300	5 000	0,061	HN 4020
	47	20	24,2	53	6,4	6 300	7 000	0,062	BK 4020
45	52	12	14,2	27,5	3,2	5 600	6 300	0,033	HK 4512
	52	16	20,5	43	5,1	5 600	6 300	0,046	HK 4516
	52	18	20,5	43	5,1	5 600	4 000	0,050	HK 4518 RS
	52	20	26	60	7,2	5 600	6 300	0,056	HK 4520
	52	20	20,5	43	5,1	–	4 000	0,054	HK 4520.2RS
	52	20	35,8	108	13,2	5 600	4 500	0,066	HN 4520
	52	20	26	60	7,2	5 600	6 300	0,072	BK 4520
	52	25	44	140	17	5 600	4 500	0,085	HN 4525
50	58	20	29,2	63	7,8	5 000	5 600	0,070	HK 5020
	58	20	41,8	120	14,3	5 000	4 000	0,085	HN 5020
	58	22	29,2	63	7,8	5 000	3 600	0,076	HK 5022 RS
	58	24	29,2	63	7,8	–	3 600	0,081	HK 5024.2RS
	58	25	36,9	85	10,6	5 000	5 600	0,090	HK 5025
	58	25	50,1	153	18,6	5 000	4 000	0,11	HN 5025

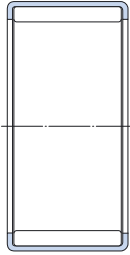

HN

Dimensions			Appropriate inner ring ¹⁾ Designation	Appropriate seal ²⁾ Designation	
F _w	C ₁ min	r _{1,2} min			
mm					
32	–	0,8	–	–	
	–	0,8	–	–	
35	–	0,8	LR 30×35×12.5	G/SD 35×42×4	
	–	0,8	LR 30×35×16.5 / IR 30×35×17	G/SD 35×42×4	
	–	0,8	LR 30×35×16.5 / IR 30×35×17	–	
	–	0,8	LR/IR 30×35×20.5	–	
	–	0,8	LR/IR 30×35×20.5	G/SD 35×42×4	
	–	0,8	LR/IR 30×35×20.5	–	
	–	0,8	LR/IR 30×35×20.5	G/SD 35×42×4	
	–	17,3	0,8	LR/IR 30×35×20.5	G/SD 35×42×4
40	–	0,8	LR 35×40×12.5	G/SD 40×47×4	
	–	0,8	LR 35×40×16.5 / IR 35×40×17	G/SD 40×47×4	
	–	0,8	LR 35×40×16.5 / IR 35×40×17	–	
	–	0,8	LR/IR 35×40×20.5	–	
	–	0,8	LR/IR 35×40×20.5	G/SD 40×47×4	
	–	0,8	LR/IR 35×40×20.5	–	
	–	0,8	LR/IR 35×40×20.5	G/SD 40×47×4	
	–	17,3	0,8	LR/IR 35×40×20.5	G/SD 40×47×4
45	–	0,8	–	G/SD 45×52×4	
	–	0,8	LR 40×45×16.5 / IR 40×45×17	G/SD 45×52×4	
	–	0,8	LR/IR 40×45×20.5	–	
	–	0,8	LR/IR 40×45×20.5	G/SD 45×52×4	
	–	0,8	LR/IR 40×45×20.5	–	
	–	0,8	LR/IR 40×45×20.5	G/SD 45×52×4	
	–	17,3	0,8	LR/IR 40×45×20.5	G/SD 45×52×4
	–	–	0,8	–	G/SD 45×52×4
50	–	0,8	LR 45×50×20.5 / IR 40×50×20 IS1	G/SD 50×58×4	
	–	0,8	LR/IR 40×50×20 IS1	G/SD 50×58×4	
	–	0,8	LR/IR 45×50×25.5	–	
	–	0,8	LR/IR 45×50×25.5	–	
	–	0,8	LR/IR 45×50×25.5	G/SD 50×58×4	
	–	0,8	LR/IR 45×50×25.5	G/SD 50×58×4	

¹⁾ For additional information, refer to the section *Needle roller bearing inner rings*, starting on page 196.

²⁾ For additional information, refer to the section *Radial shaft seals with a low cross sectional height*, starting on page 208.

Drawn cup needle roller bearings
F_w 55 – 60 mm

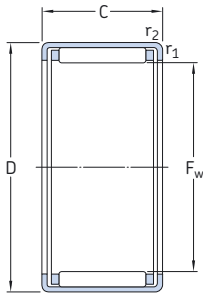

HK

Principal dimensions			Basic load ratings		Fatigue load limit	Speed ratings		Mass	Designation
F _w	D	C	dynamic	static		Reference speed	Limiting speed		
			C	C ₀	P _u				
mm			kN		kN	r/min		kg	–
55	63	20	30,3	67	8,3	4 500	5 000	0,074	HK 5520
	63	28	41,8	104	12,9	4 500	5 000	0,11	HK 5528
60	68	12	17,6	32	3,8	4 300	4 800	0,049	HK 6012
	68	20	31,9	75	9,3	4 300	4 800	0,081	HK 6020
	68	32	51,2	137	17	4 300	4 800	0,14	HK 6032

Dimensions		Appropriate inner ring ¹⁾ Designation	Appropriate seal ²⁾ Designation
F _w	r _{1,2} min		
mm			
55	0,8	LR 50×55×20.5	G 55×63×5
	0,8	–	G 55×63×5
60	0,8	–	–
	0,8	–	–
	0,8	–	–

¹⁾ For additional information, refer to the section *Needle roller bearing inner rings*, starting on **page 196**.

²⁾ For additional information, refer to the section *Radial shaft seals with a low cross sectional height*, starting on **page 208**.



Needle roller bearings with machined rings

Needle roller bearings with machined rings with flanges	100
Needle roller bearings with machined rings without flanges	102
Dimensions.....	102
Tolerances	102
Internal clearance	103
Misalignment.....	101
Cages	104
Shaft and housing tolerances	104
Supplementary designations.....	105
Product tables	106
4.1 Needle roller bearings with machined rings with flanges, without an inner ring.....	106
4.2 Needle roller bearings with machined rings with flanges, with an inner ring	122
4.3 Needle roller bearings with machined rings without flanges, without an inner ring	134
4.4 Needle roller bearings with machined rings without flanges, with an inner ring.....	138

Needle roller bearings with machined rings

Needle roller bearings with machined rings made of carbon chromium bearing steel have a low sectional height and a very high load carrying capacity for their size. They may be used with or without an inner ring, depending on the application.

Needle roller bearings without an inner ring (→ **fig. 1**) are an excellent choice for compact bearing arrangements if the shaft can be hardened and ground. Eliminating the need for a separate inner ring enables a larger shaft diameter and a stiffer arrangement. Axial displacement of the shaft relative to the housing is only limited by the width of the raceway on the shaft. By machining the shaft raceways to the appropriate dimensional and form accuracy, it is possible to obtain bearing arrangements with heightened running accuracy. For additional information, refer to the section *Raceways on shafts and in housings* on **page 50** and to *Internal clearance* on **page 42**.

Needle roller bearings with an inner ring (→ **fig. 2**) are used for arrangements where it is not possible or uneconomical to harden and grind the shaft. Bearings with an inner ring only permit axial displacement of the shaft relative to the housing within certain limits. If the permissible axial displacement provided by a standard inner ring is insufficient, it is possible to use an extended inner ring. Extended inner rings can also provide an excellent counterface for the lips of external G or SD seals. For additional information, refer to the section *Needle roller bearing components*, starting on **page 195**.

SKF supplies needle roller bearings in several designs and sizes:

- with flanges (closure rings or integral flanges) on the outer ring (→ **figs. 3** and **4**), sealed (→ **fig. 5**) or not sealed and with or without an inner ring
- without flanges on the outer ring (→ **fig. 6**), not sealed and with or without an inner ring

To accommodate combined radial and axial loads, needle roller bearings of certain sizes can be combined with needle roller thrust bearings with a centring spigot, AXW series (→ **fig. 7**).

Fig. 1

Needle roller bearing without an inner ring

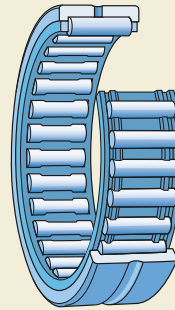

Fig. 2

Needle roller bearing with an inner ring

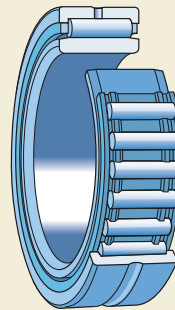

Fig. 3

Needle roller bearing with inserted closure rings (for bearings with $F_w \leq 10$ mm)

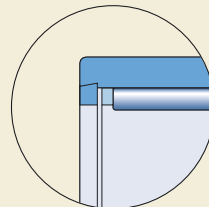

Fig. 4

Needle roller bearing with integral outer ring flanges
(for bearings with $F_w \geq 12$ mm)

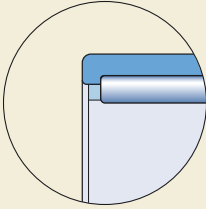

Fig. 7

Needle roller bearing combined with a needle roller thrust bearing, AXW series

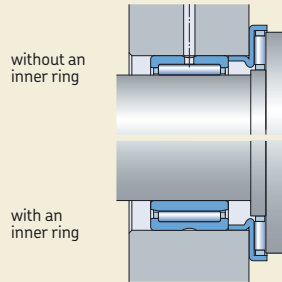

Fig. 5

Needle roller bearing, sealed

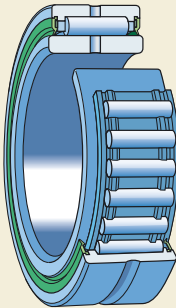
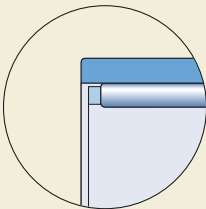

Fig. 6

Needle roller bearing without flanges on the outer ring



Needle roller bearings with machined rings with flanges

SKF needle roller bearings with flanges on the outer ring and with an outside diameter up to and including 17 mm ($F_w \leq 10$ mm), are manufactured with inserted closure rings. These bearings do not have a lubrication hole or an annular groove (→ **fig. 8**). Larger bearings have integral flanges on the outer ring, an annular groove and, depending on the bearing size, one or more lubrication holes in the outer ring (→ **fig. 9**). Needle roller bearings with flanges are generally designed as single row bearings. Bearings in the RNA 69 and NA 69 series, with an outside diameter $D \geq 52$ mm, have two needle roller and cage assemblies (→ **fig. 10**). The outer ring and cage assembly of a needle roller bearing with flanges form a non-separable unit.

Fig. 8

Design with inserted closure rings, without a lubrication hole

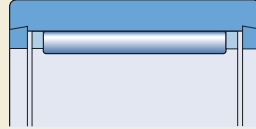

NK series ($F_w \leq 10$ mm)

Fig. 9

Design with integral flanges, with a lubrication hole and an annular groove

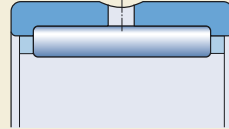

NK series ($F_w \geq 12$ mm)
 NKS series
 RNA 48 series
 RNA 49 series
 RNA 69 series ($D \leq 47$ mm)

Fig. 10

Needle roller bearing, double row

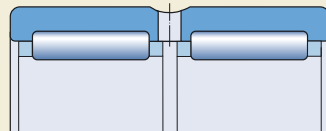

RNA series ($D \geq 52$ mm)

Sealed bearings

Single row bearings, in the RNA 49 and NA 49 series, are also available with a contact seal on one (→ **fig. 11**) or both sides (→ **fig. 12**). The seals are made of acrylonitrile-butadiene rubber (NBR) that efficiently protects the bearing against the entry of contaminants and retains the lubricant in the bearing.

The operating temperature range for sealed needle roller bearings with machined rings, which is limited by the seal material and the grease fill, is -20 °C to $+100\text{ °C}$.

The inner ring of sealed bearings is 1 mm wider than the outer ring. This maintains the efficiency of the seals even when a small amount of axial displacement occurs.

Initial grease fill and relubrication

Sealed needle roller bearings with machined rings are filled at the factory with a high-quality grease with good rust inhibiting properties. Because these bearings can hold a relatively large quantity of grease, they can be operated for long periods before relubrication is required. The lubrication groove and lubrication hole in the outer ring enable the lubricant to reach the bearing cavity during relubrication. The inner ring is also provided with a lubrication hole so that the bearing can be relubricated either via the outer or inner ring, depending on the application. SKF recommends SKF LGWA 2 grease for relubrication. For additional information about greases, refer to the section *Lubrication*, starting on **page 52**.

External seals

SKF supplies an assortment of radial shaft seals that can be used as external seals. Extended inner rings can be used if the inner ring raceway is to serve as a counterface for a seal adjacent to the bearing. Appropriate seals are listed in the product tables, when available. For additional information, refer to the section *Needle roller bearing components*, starting on **page 195**.

Fig. 11

Needle roller bearing, sealed on one side

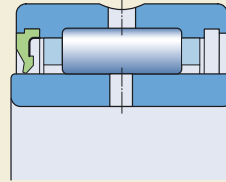

NA 49.. RS series

Fig. 12

Needle roller bearing, sealed on both sides

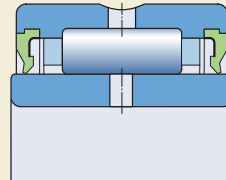

NA 49...2RS series

Needle roller bearings with machined rings without flanges

Needle roller bearings without flanges are completely separable, i.e. the outer ring, the needle roller and cage assembly and the inner ring can all be mounted separately. In many applications, this makes mounting a great deal easier. The needle roller and cage assembly can either be mounted together with the outer ring or with the shaft or inner ring, depending on the arrangement design. It can also be inserted between the outer ring and shaft or inner ring as the final step. However, needle roller and cage assemblies and bearing outer rings must always be kept together as supplied.

SKF needle roller bearings without flanges are available as single row (→ **fig. 13**) or double row bearings (→ **fig. 14**). Double row bearings have two needle roller and cage assemblies arranged adjacent to each other. They have an annular groove and a lubrication hole in the outer ring to enable efficient lubrication.

To provide efficient lubrication for needle roller bearings with an inner ring, SKF supplies some bearings with one lubrication hole in the inner ring. These bearings are listed in the product table. The cage of needle roller bearings without flanges must be axially guided by fine turned and burr-free surfaces on adjacent machine components. Recommended dimensions for these surfaces are listed in the product tables.

Dimensions

The boundary dimensions of SKF needle roller bearings with machined rings in the RNA 48, RNA 49, RNA 69, NA 48, NA 49 and NA 69 series are in accordance with ISO 1206-2001. The dimensions of the other needle roller bearings do not adhere to any national or international standards, but are common in the market.

Tolerances

SKF supplies needle roller bearings with machined rings to Normal tolerances in accordance with ISO 492:2002, as standard.

On request, needle roller bearings with higher accuracy to tolerance P6 or P5 specifications can be supplied. For bearing arrangements with higher accuracy, inner rings with a pre-ground raceway and a machining allowance can be supplied, but must be finish ground after mounting.

The inside diameter F_w of the needle roller and cage assembly, when the rollers are in contact with the outer ring raceway, lies within the limits of F6 tolerance class (→ **table 1**) before the bearings are mounted.

On request, SKF supplies needle roller bearings without an inner ring and with reduced inside diameter tolerances. These bearings are identified by the designation suffix H followed by a figure combination that gives the actual maximum and minimum values in μm for the deviation from the nominal inside diameter F_w , e.g. H+24+20.

Fig. 13

Needle roller bearing, single row, with an inner ring

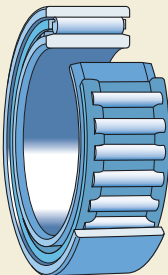

NAO series

Fig. 14

Needle roller bearing, double row, without an inner ring

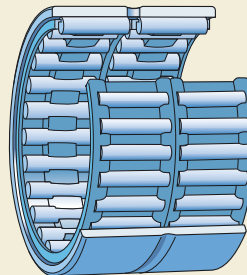

RNAO series

Internal clearance

SKF needle roller bearings with an inner ring have Normal radial internal clearance as standard. The clearance values are listed in **table 7** on **page 42** and are in accordance with ISO 5753:1991. They are valid for unmounted bearings under zero measuring load.

For needle roller bearings without an inner ring, a suitable internal clearance is achieved by selecting the appropriate tolerance class for the raceway diameter. Recommended values are listed in **table 2**. The recommendations apply, provided the housing bore is not tighter than a K7 tolerance class.

Misalignment

The ends of the needle rollers are relieved slightly to modify the line contact between the raceways and rollers. This provides favourable load distribution in the bearing and minimizes damaging edge stresses. It also enables needle roller bearings with machined rings to accommodate a small amount of misalignment, approximately 1 min of arc between the shaft and housing.

The detrimental effects of misalignment increase with increasing bearing width and load. For additional information, contact the SKF application engineering service.

Table 1

ISO tolerance class		F6 tolerance class	
Nominal inside diameter			
F_w over	incl.	high	low
mm		µm	
–	3	+12	+6
3	6	+18	+10
6	10	+22	+13
10	18	+27	+16
18	30	+33	+20
30	50	+41	+25
50	80	+49	+30
80	120	+58	+36
120	180	+68	+43
180	250	+79	+50
250	315	+88	+56
315	400	+98	+62
400	500	+108	+68

Table 2

Shaft tolerance classes for needle roller bearings without an inner ring				
Nominal inside diameter		Shaft tolerance classes for shaft raceways to give operational clearance		
F_w over	incl.	lower side	medium	higher side
mm		–		
–	65	k5	h5	g6
65	80	k5	h5	f6
80	160	k5	g5	f6
160	180	k5	g5	e6
180	200	j5	g5	e6
200	250	j5	f6	e6
250	315	h5	f6	e6
315	400	g5	f6	d6

Fig. 15

Machined steel cage

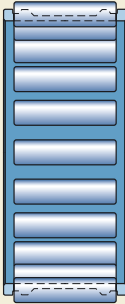

Fig. 16

Sheet steel cage

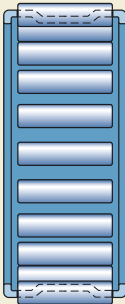
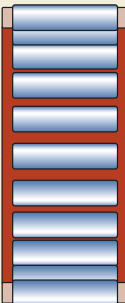

Fig. 17

Polyamide 66 cage



Cages

Depending on their size, SKF needle roller bearings with machined rings are fitted as standard with a machined steel (→ **fig. 15**) or sheet steel cage (→ **fig. 16**), no designation suffix. A number of bearings are fitted as standard with an injection moulded cage of glass fibre reinforced polyamide 66 (→ **fig. 17**), designation suffix TN.

Note

Needle roller bearings with a polyamide 66 cage that are not sealed can be operated at temperatures up to 120 °C. The lubricants generally used for rolling bearings do not have a detrimental effect on cage properties. Exceptions are a few synthetic oils and greases with a synthetic oil base and lubricants containing a high proportion of EP additives when used at high temperatures.

For bearing arrangements that operate at continuously high temperatures or under arduous conditions, SKF recommends using bearings with a steel cage.

For additional information about the temperature resistance and the applicability of cages, refer to the section *Cage materials*, starting on **page 44**.

Shaft and housing tolerances

The shaft tolerances for SKF needle roller bearings with machined rings should be in accordance with the fits that are listed in **table 3**.

When needle roller bearings with an inner ring are used under conditions of point load and mounted with a loose fit, the inner ring seat should be machined to h6 or g6 tolerance class.

When the load rotates, the inner rings should have an interference fit. Sufficient interference can be obtained if the recommended shaft tolerance classes (→ **table 3**) are applied.

For information about housing tolerances for needle roller bearings with an inner ring, refer to the SKF *General Catalogue*, section *Application of bearings/Recommended fits*.

Table 3

Fits for needle roller bearings with machined rings with an inner ring on solid steel shafts

Conditions	Shaft diameter	Tolerance class
–	mm	–
Rotating inner ring load or direction of load indeterminate		
Light and variable loads ($P \leq 0,05 C$)	≤ 10 (10) to 25 (25) to 100	k5 k6 m6
Normal to heavy loads ($P > 0,05 C$)	≤ 25 (25) to 60 (60) to 100 (100) to 400	k5 m6 n6 p6 ¹⁾
Heavy to very heavy loads ($P > 0,1 C$)	(50) to 100 (100) to 200 > 200	n6 ¹⁾ p6 ¹⁾ r6 ¹⁾
Stationary inner ring load Easy axial displacement of the inner ring on the shaft necessary		g6
Easy axial displacement of the inner ring on the shaft unnecessary		h6

¹⁾ Bearings with radial internal clearance greater than Normal may be necessary.

Supplementary designations

The designation suffixes used to identify certain features of SKF needle roller bearings are explained in the following.

- C2** Bearing internal clearance smaller than Normal
- C3** Radial internal clearance greater than Normal
- C4** Radial internal clearance greater than C3
- CN** Bearing internal clearance Normal, only used together with an additional letter (H, L, M, P) that identifies a reduced or displaced clearance range
- H..** Needle roller bearing without an inner ring, with reduced inside diameter (under rollers) tolerance, followed by tolerance limits in μm , e.g. H+27+20
- IS..** Needle roller bearing with one or more lubricating holes in the inner ring, a figure following indicates the number of holes
- ISR..** Needle roller bearing with an annular groove and one or more lubricating holes in the inner ring, a figure following indicates the number of holes
- P5** Dimensional and running accuracy to ISO tolerance class 5 specifications (better than P6)
- P6** Dimensional and running accuracy to ISO tolerance class 6 specifications (better than Normal)
- RS** Contact seal of acrylonitrile-butadiene rubber (NRB) with or without sheet steel reinforcement on one side of the bearing
- .2RS** RS contact seal on both sides of the bearing
- TN** Injection moulded cage of glass fibre reinforced polyamide 66, rolling element centred

Needle roller bearings with machined rings with flanges, without an inner ring

F_w 5 – 16 mm

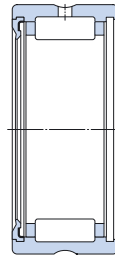
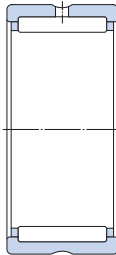
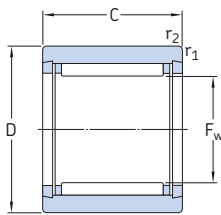

NK ($F_w \leq 10$ mm)

NK ($F_w \geq 12$ mm)
RNA 49
RNA 6901

RNA 49..RS

RNA 49...2RS

Principal dimensions			Basic load ratings		Fatigue load limit P_u	Speed ratings		Mass	Designation
F_w	D	C	dynamic	static		Reference speed	Limiting speed		
mm			C	C_0	kN	r/min	kg	–	
5	10	10	2,29	2	0,212	36 000	40 000	0,0031	NK 5/10 TN NK 5/12 TN
	10	12	2,92	2,7	0,29	36 000	40 000	0,0037	
6	12	10	2,55	2,36	0,25	34 000	38 000	0,0047	NK 6/10 TN NK 6/12 TN
	12	12	3,3	3,2	0,345	34 000	38 000	0,0057	
7	14	10	2,81	2,75	0,29	32 000	36 000	0,0069	NK 7/10 TN NK 7/12 TN
	14	12	3,58	3,75	0,415	32 000	36 000	0,0082	
8	15	12	3,8	4,25	0,465	32 000	36 000	0,0087	NK 8/12 TN NK 8/16 TN
	15	16	5,01	5,85	0,67	32 000	36 000	0,012	
9	16	12	4,4	5,2	0,57	30 000	34 000	0,010	NK 9/12 TN NK 9/16 TN
	16	16	5,72	7,2	0,815	30 000	34 000	0,013	
10	17	12	4,4	5,4	0,62	28 000	32 000	0,010	NK 10/12 TN NK 10/16 TN
	17	16	5,94	8	0,9	28 000	32 000	0,013	
12	19	12	6,71	8,15	0,965	26 000	30 000	0,012	NK 12/12 NK 12/16
	19	16	9,13	12	1,46	26 000	30 000	0,016	
14	22	13	8,8	10,4	1,25	26 000	30 000	0,017	RNA 4900 RNA 4900 RS RNA 4900.2RS NK 14/16 NK 14/20
	22	13	7,37	8,15	0,95	13 000	12 000	0,016	
	22	13	7,37	8,15	0,95	–	12 000	0,016	
	22	16	10,2	12,5	1,53	24 000	28 000	0,021	
	22	20	12,8	16,6	2,08	24 000	28 000	0,026	
15	23	16	11	14	1,7	24 000	26 000	0,022	NK 15/16 NK 15/20
	23	20	13,8	18,3	2,28	24 000	26 000	0,027	
16	24	13	9,9	12,2	1,46	22 000	26 000	0,017	RNA 4901 RNA 4901 RS RNA 4901.2RS NK 16/16 NK 16/20 RNA 6901
	24	13	8,09	9,65	1,14	22 000	11 000	0,018	
	24	13	8,09	9,65	1,14	–	11 000	0,018	
	24	16	11,7	15,3	1,86	22 000	26 000	0,022	
	24	20	14,5	20	2,5	22 000	26 000	0,028	
	24	22	16,1	23,2	2,9	22 000	26 000	0,031	

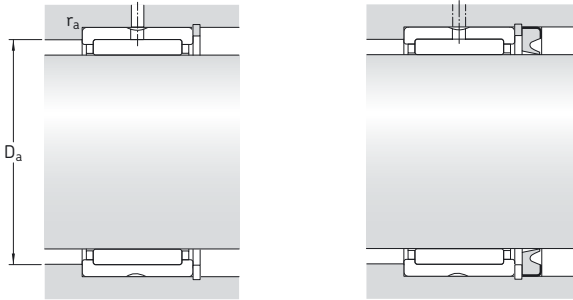

Dimensions		Abutment and fillet dimensions		Appropriate seal ¹⁾
F _w	r _{1,2} min	D _a max	r _a max	Designation
mm		mm		–
5	0,15	8,8	0,1	G 5×10×2 S
	0,15	8,8	0,1	G 5×10×2 S
6	0,15	10,8	0,1	G 6×12×2 S
	0,15	10,8	0,1	G 6×12×2 S
7	0,3	12	0,3	G 7×14×2
	0,3	12	0,3	G 7×14×2
8	0,3	13	0,3	G/SD 8×15×3
	0,3	13	0,3	G/SD 8×15×3
9	0,3	14	0,3	G 9×16×3
	0,3	14	0,3	G 9×16×3
10	0,3	15	0,3	G/SD 10×17×3
	0,3	15	0,3	G/SD 10×17×3
12	0,3	17	0,3	G/SD 12×19×3
	0,3	17	0,3	G/SD 12×19×3
14	0,3	20	0,3	G/SD 14×22×3
	0,3	20	0,3	–
	0,3	20	0,3	–
	0,3	20	0,3	G/SD 14×22×3
	0,3	20	0,3	G/SD 14×22×3
15	0,3	21	0,3	G/SD 15×23×3
	0,3	21	0,3	G/SD 15×23×3
16	0,3	22	0,3	G/SD 16×24×3
	0,3	22	0,3	–
	0,3	22	0,3	–
	0,3	22	0,3	G/SD 16×24×3
	0,3	22	0,3	G/SD 16×24×3
	0,3	22	0,3	G/SD 16×24×3

¹⁾ For additional information, refer to the section *Radial shaft seals with a low cross sectional height*, starting on **page 208**.
For additional information about SKF seals, refer to the SKF catalogue *Industrial shaft seals*.

Needle roller bearings with machined rings with flanges, without an inner ring F_w 17 – 24 mm

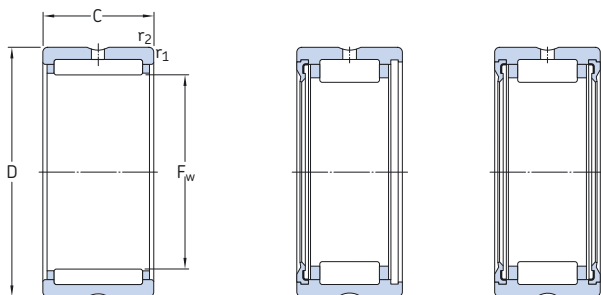

NK(S)
RNA 49
RNA 69

RNA 49.. RS

RNA 49...2RS

Principal dimensions			Basic load ratings		Fatigue load limit P _u	Speed ratings		Mass	Designation
F _w	D	C	dynamic	static		Reference speed	Limiting speed		
mm			C	C ₀	kN	r/min	kg	–	
17	25	16	12,1	16,6	2	22 000	26 000	0,024	NK 17/16
	25	20	15,1	22	2,75	22 000	26 000	0,030	NK 17/20
18	26	16	12,8	17,6	2,16	22 000	24 000	0,025	NK 18/16
	26	20	16,1	23,6	3	22 000	24 000	0,031	NK 18/20
19	27	16	13,4	19	2,32	20 000	24 000	0,026	NK 19/16
	27	20	16,5	25,5	3,2	20 000	24 000	0,032	NK 19/20
20	28	13	11,2	15,3	1,83	19 000	22 000	0,022	RNA 4902
	28	13	9,13	12	1,4	19 000	9 500	0,022	RNA 4902 RS
	28	13	9,13	12	1,4	–	9 500	0,022	RNA 4902.2RS
	28	16	13,2	19,3	2,36	19 000	22 000	0,027	NK 20/16
	28	20	16,5	25,5	3,2	19 000	22 000	0,034	NK 20/20
	32	20	23,3	27	3,45	18 000	20 000	0,049	NKS 20
	28	23	17,2	27	3,4	19 000	22 000	0,040	RNA 6902
21	29	16	13,8	20,4	2,5	19 000	22 000	0,028	NK 21/16
	29	20	17,2	27	3,45	19 000	22 000	0,035	NK 21/20
22	30	13	11,4	16,3	1,96	18 000	20 000	0,022	RNA 4903
	30	13	9,52	12,9	1,5	18 000	9 000	0,023	RNA 4903 RS
	30	13	9,52	12,9	1,5	–	9 000	0,023	RNA 4903.2RS
	30	16	14,2	21,6	2,65	18 000	20 000	0,030	NK 22/16
	30	20	17,9	29	3,65	18 000	20 000	0,037	NK 22/20
	30	23	18,7	30,5	3,9	18 000	20 000	0,042	RNA 6903
	35	20	24,6	30	3,9	16 000	19 000	0,062	NKS 22
24	32	16	15,4	24,5	3	16 000	19 000	0,032	NK 24/16
	32	20	19	32,5	4,05	16 000	19 000	0,040	NK 24/20
	37	20	26	33,5	4,25	15 000	17 000	0,066	NKS 24

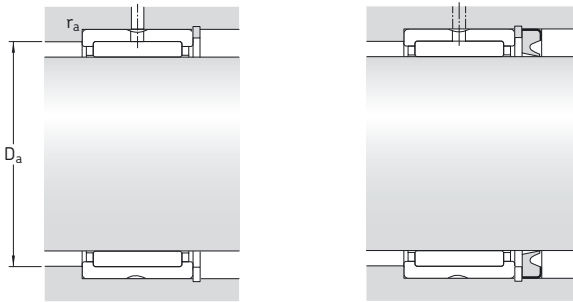

Dimensions		Abutment and fillet dimensions		Appropriate seal ¹⁾
F _w	r _{1,2} min	D _a max	r _a max	Designation
mm		mm		–
17	0,3	23	0,3	G/SD 17×25×3
	0,3	23	0,3	G/SD 17×25×3
18	0,3	24	0,3	G/SD 18×26×4
	0,3	24	0,3	G/SD 18×26×4
19	0,3	25	0,3	G/SD 19×27×4
	0,3	25	0,3	G/SD 19×27×4
20	0,3	26	0,3	G/SD 20×28×4
	0,3	26	0,3	–
	0,3	26	0,3	–
	0,3	26	0,3	G/SD 20×28×4
	0,3	26	0,3	G/SD 20×28×4
	0,6	28	0,6	CR 20×32×7 CRW1 R
	0,3	26	0,3	G/SD 20×28×4
21	0,3	27	0,3	G 21×29×4
	0,3	27	0,3	G 21×29×4
22	0,3	28	0,3	G/SD 22×30×4
	0,3	28	0,3	–
	0,3	28	0,3	–
	0,3	28	0,3	G/SD 22×30×4
	0,3	28	0,3	G/SD 22×30×4
	0,3	28	0,3	G/SD 22×30×4
	0,6	31	0,6	CR 22×35×7 CRW1 R
24	0,3	30	0,3	G/SD 24×32×4
	0,3	30	0,3	G/SD 24×32×4
	0,6	33	0,6	–

¹⁾ For additional information, refer to the section *Radial shaft seals with a low cross sectional height*, starting on **page 208**.
For additional information about SKF seals, refer to the SKF catalogue *Industrial shaft seals*.

Needle roller bearings with machined rings with flanges, without an inner ring
 F_w 25 – 32 mm

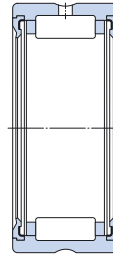
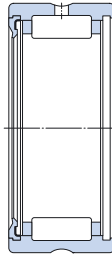
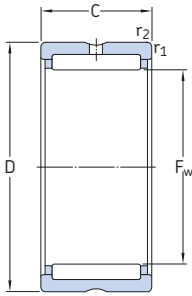

NK(S)
 RNA 49
 RNA 69

RNA 49..RS

RNA 49...2RS

Principal dimensions			Basic load ratings		Fatigue load limit P_u	Speed ratings		Mass	Designation
F_w	D	C	dynamic	static		Reference speed	Limiting speed		
mm			C	C_0	kN	r/min	kg	–	
25	33	16	15,1	24,5	3	16 000	18 000	0,033	NK 25/16
	33	20	19	32,5	4,15	16 000	18 000	0,042	NK 25/20
	37	17	21,6	28	3,55	15 000	17 000	0,052	RNA 4904
	37	17	19,4	22,4	2,75	15 000	7 500	0,056	RNA 4904 RS
	37	17	19,4	22,4	2,75	–	7 500	0,056	RNA 4904.2RS
	37	30	35,2	53	6,95	15 000	17 000	0,10	RNA 6904
	38	20	27,5	36	4,55	15 000	17 000	0,068	NKS 25
26	34	16	15,7	26	3,2	15 000	17 000	0,034	NK 26/16
	34	20	19,4	34,5	4,3	15 000	17 000	0,042	NK 26/20
28	37	20	22	36,5	4,65	14 000	16 000	0,052	NK 28/20
	37	30	31,9	60	7,8	14 000	16 000	0,082	NK 28/30
	39	17	23,3	32	4,05	14 000	15 000	0,050	RNA 49/22
	39	30	36,9	57	7,5	14 000	15 000	0,098	RNA 69/22
	42	20	28,6	39	5	13 000	15 000	0,084	NKS 28
29	38	20	24,6	42,5	5,2	14 000	15 000	0,050	NK 29/20 TN
	38	30	31,9	60	7,8	14 000	15 000	0,084	NK 29/30
30	40	20	25,5	44	5,5	13 000	15 000	0,061	NK 30/20 TN
	40	30	36,9	72	9	13 000	15 000	0,093	NK 30/30 TN
	42	17	24,2	34,5	4,3	13 000	15 000	0,061	RNA 4905
	42	17	21,6	27,5	3,35	13 000	6 300	0,060	RNA 4905 RS
	42	17	21,6	27,5	3,35	–	6 300	0,060	RNA 4905.2RS
	42	30	38	62	8,15	13 000	15 000	0,11	RNA 6905
	45	22	31,9	43	5,5	12 000	14 000	0,10	NKS 30
32	42	20	26,4	48	6	12 000	14 000	0,064	NK 32/20 TN
	42	30	34,1	65,5	8,65	12 000	14 000	0,10	NK 32/30
	45	17	25,1	36,5	4,55	12 000	14 000	0,073	RNA 49/28
	45	30	39,6	65,5	8,65	12 000	14 000	0,14	RNA 69/28
	47	22	34,1	46,5	6	12 000	14 000	0,11	NKS 32

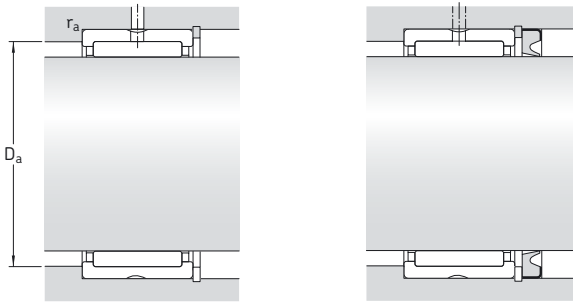

Dimensions		Abutment and fillet dimensions		Appropriate seal ¹⁾ Designation
F_w	$r_{1,2}$ min	D_a max	r_a max	
mm		mm		–
25	0,3	31	0,3	G/SD 25×33×4
	0,3	31	0,3	G/SD 25×33×4
	0,3	35	0,3	CR 25×35×7 CRW1 R
	0,3	35	0,3	–
	0,3	35	0,3	–
	0,6	34	0,6	CR 25×38×7 CRW1 R
26	0,3	32	0,3	G/SD 26×34×4
	0,3	32	0,3	G/SD 26×34×4
28	0,3	35	0,3	G 28×37×4
	0,3	35	0,3	G 28×37×4
	0,3	37	0,3	–
	0,3	37	0,3	–
	0,6	38	0,6	CR 28×42×7 CRW1 R
29	0,3	36	0,3	G 29×38×4
	0,3	36	0,3	G 29×38×4
30	0,3	38	0,3	G/SD 30×40×4
	0,3	38	0,3	G/SD 30×40×4
	0,3	40	0,3	CR 30×42×7 CRW1 R
	0,3	40	0,3	–
	0,3	40	0,3	–
	0,6	40	0,3	CR 30×42×7 CRW1 R
32	0,3	40	0,3	G/SD 32×42×4
	0,3	40	0,3	G/SD 32×42×4
	0,3	43	0,3	G 32×45×4
	0,3	43	0,3	G 32×45×4
	0,6	43	0,6	CR 32×47×8 CRW1 R

¹⁾ For additional information, refer to the section *Radial shaft seals with a low cross sectional height*, starting on **page 208**.
For additional information about SKF seals, refer to the SKF catalogue *Industrial shaft seals*.

Needle roller bearings with machined rings with flanges, without an inner ring

F_w 35 – 47 mm

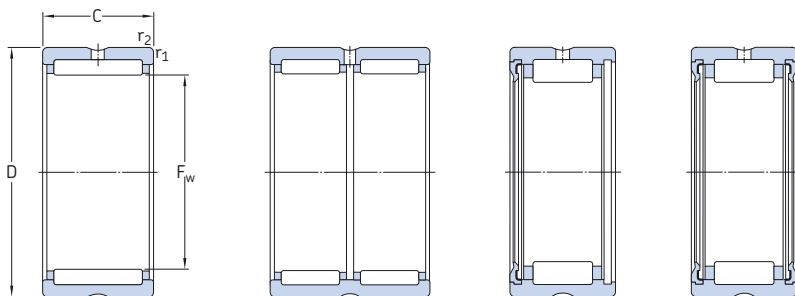

NK(S)
RNA 49
RNA 69 (D ≤ 47 mm)

RNA 69 (D ≥ 52 mm)

RNA 49..RS

RNA 49...2RS

Principal dimensions			Basic load ratings		Fatigue load limit P_u	Speed ratings		Mass	Designation
F_w	D	C	dynamic	static		Reference speed	Limiting speed		
mm			C	C_0	kN	r/min	kg	–	
35	45	20	27,5	52	6,55	11 000	13 000	0,070	NK 35/20 TN
	45	30	40,2	85	10,6	11 000	13 000	0,11	NK 35/30 TN
	47	17	25,5	39	4,9	11 000	13 000	0,069	RNA 4906
	47	17	23,3	32	3,9	11 000	5 600	0,069	RNA 4906 RS
	47	17	23,3	32	3,9	–	5 600	0,069	RNA 4906.2RS
	47	30	42,9	75	9,8	11 000	13 000	0,13	RNA 4906
	50	22	35,2	50	6,4	11 000	12 000	0,12	NKS 35
37	47	20	25,1	46,5	5,85	11 000	12 000	0,077	NK 37/20
	47	30	36,9	76,5	10	11 000	12 000	0,11	NK 37/30
	52	22	36,9	54	6,95	10 000	12 000	0,12	NKS 37
38	48	20	25,5	49	6,2	11 000	12 000	0,079	NK 38/20
	48	30	37,4	80	10,4	11 000	12 000	0,12	NK 38/30
40	50	20	30,3	61	7,5	10 000	11 000	0,078	NK 40/20 TN
	50	30	38	83	10,8	10 000	11 000	0,13	NK 40/30
	52	20	30,8	51	6,55	10 000	11 000	0,089	RNA 49/32
	52	36	47,3	90	11,2	10 000	11 000	0,16	RNA 69/32
	55	22	38	57	7,35	9 500	11 000	0,13	NKS 40
42	52	20	27	53	6,7	9 500	11 000	0,086	NK 42/20
	52	30	39,1	86,5	11,2	9 500	11 000	0,13	NK 42/30
	55	20	31,9	54	6,95	9 500	11 000	0,11	RNA 4907
	55	20	27	43	5,4	9 500	4 800	0,11	RNA 4907 RS
	55	20	27	43	5,4	–	4 800	0,11	RNA 4907.2RS
	55	36	48,4	93	11,8	9 500	11 000	0,19	RNA 6907
43	53	20	27,5	55	6,95	9 500	11 000	0,086	NK 43/20
	53	30	40,2	90	11,6	9 500	11 000	0,13	NK 43/30
	58	22	39,1	61	7,8	9 000	10 000	0,14	NKS 43
45	55	20	31,4	67	8,3	9 000	10 000	0,086	NK 45/20 TN
	55	30	45,7	108	13,4	9 000	10 000	0,14	NK 45/30 TN
	60	22	40,2	64	8,3	8 500	10 000	0,15	NKS 45
47	57	20	29,2	61	7,65	8 500	10 000	0,095	NK 47/20
	57	30	41,8	98	12,9	8 500	10 000	0,14	NK 47/30

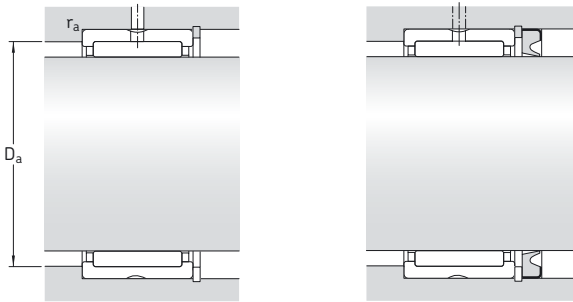

Dimensions		Abutment and fillet dimensions		Appropriate seal ¹⁾ Designation
F _w	r _{1,2} min	D _a max	r _a max	
mm		mm		–
35	0,3	43	0,3	G/SD 35×45×4
	0,3	43	0,3	G/SD 35×45×4
	0,3	45	0,3	CR 35×47×7 CRW1 R
	0,3	45	0,3	–
	0,3	45	0,3	–
	0,6	46	0,6	CR 35×47×7 CRW1 R CR 35×50×8 CRW1 R
37	0,3	45	0,3	G/SD 37×47×4
	0,3	45	0,3	G/SD 37×47×4
	0,6	48	0,6	–
38	0,3	46	0,3	G/SD 38×48×4
	0,3	46	0,3	G/SD 38×48×4
40	0,3	48	0,3	G/SD 40×50×4
	0,3	48	0,3	G/SD 40×50×4
	0,6	48	0,6	G/SD 40×52×5
	0,6	48	0,6	G/SD 40×52×5
	0,6	51	0,6	CR 40×55×8 CRW1 R
42	0,3	50	0,3	G/SD 42×52×4
	0,3	50	0,3	G/SD 42×52×4
	0,6	51	0,6	CR 42×55×8 CRW R
	0,6	51	0,6	–
	0,6	51	0,6	–
	0,6	51	0,6	–
43	0,3	51	0,3	G 43×53×4
	0,3	51	0,3	G 43×53×4
	0,6	53	0,6	–
45	0,3	53	0,3	G/SD 45×55×4
	0,3	53	0,3	G/SD 45×55×4
	0,6	56	0,6	CR 45×60×8 CRW1 R
47	0,3	55	0,3	–
	0,3	55	0,3	–

¹⁾ For additional information, refer to the section *Radial shaft seals with a low cross sectional height*, starting on **page 208**.
For additional information about SKF seals, refer to the SKF catalogue *Industrial shaft seals*.

Needle roller bearings with machined rings with flanges, without an inner ring

F_w 48 – 68 mm

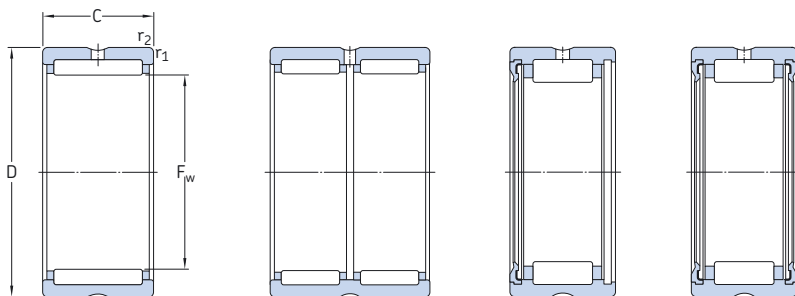

NK(S)
RNA 49

RNA 69

RNA 49..RS

RNA 49...2RS

Principal dimensions			Basic load ratings		Fatigue load limit P_u	Speed ratings		Mass	Designation
F_w	D	C	dynamic	static		Reference speed	Limiting speed		
mm			C	C_0	kN	r/min	kg	–	
48	62	22	42,9	71	9,15	8 000	9 500	0,14	RNA 4908 RNA 4908 RS RNA 4908.2RS RNA 6908
	62	22	36,9	58,5	7,35	8 000	4 000	0,15	
	62	22	36,9	58,5	7,35	–	4 000	0,15	
	62	40	67,1	125	16	8 000	9 500	0,26	
50	62	25	42,9	93	11,2	8 000	9 000	0,15	NK 50/25 TN NK 50/35 TN NKS 50
	62	35	58,3	137	17	8 000	9 000	0,21	
	65	22	42,9	72	9,15	8 000	9 000	0,16	
52	68	22	45,7	78	10	7 500	8 500	0,18	RNA 4909 RNA 4909 RS RNA 4909.2RS RNA 6909
	68	22	39,1	64	8	7 500	3 800	0,16	
	68	22	39,1	64	8	–	3 800	0,16	
	68	40	70,4	137	17,3	7 500	8 500	0,34	
55	68	25	40,2	88	11,2	7 500	8 500	0,18	NK 55/25 NK 55/35 NKS 55
	68	35	52,3	122	16	7 500	8 500	0,25	
	72	22	44,6	78	10	7 000	8 000	0,22	
58	72	22	47,3	85	11	7 000	8 000	0,16	RNA 4910 RNA 4910 RS RNA 4910.2RS RNA 6910
	72	22	40,2	69,5	8,8	7 000	3 400	0,16	
	72	22	40,2	69,5	8,8	–	3 400	0,16	
	72	40	73,7	150	19	7 000	8 000	0,31	
60	72	25	46,8	110	13,4	6 700	7 500	0,17	NK 60/25 TN NK 60/35 NKS 60
	72	35	55	134	17,6	6 700	7 500	0,26	
	80	28	62,7	104	13,7	6 300	7 500	0,34	
63	80	25	57,2	106	13,7	6 300	7 000	0,26	RNA 4911 RNA 6911
	80	45	89,7	190	24	6 300	7 000	0,47	
65	78	25	44	104	13,2	6 300	7 000	0,22	NK 65/25 NK 65/35 NKS 65
	78	35	58,3	146	19,3	6 300	7 000	0,31	
	85	28	66	114	15	6 000	6 700	0,36	
68	82	25	44	95	12	6 000	6 700	0,24	NK 68/25 NK 68/35 RNA 4912 RNA 6912
	82	35	60,5	146	19	6 000	6 700	0,34	
	85	25	60,5	114	14,6	6 000	6 700	0,28	
	85	45	93,5	204	26	6 000	6 700	0,49	

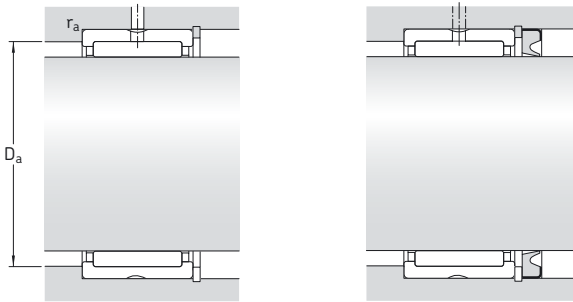

Dimensions		Abutment and fillet dimensions		Appropriate seal ¹⁾ Designation
F _w	r _{1,2} min	D _a max	r _a max	
mm		mm		–
48	0,6	58	0,6	CR 48×62×8 CRW1 R
	0,6	58	0,6	–
	0,6	58	0,6	–
	0,6	58	0,6	–
50	0,6	58	0,6	G/SD 50×62×5
	0,6	58	0,6	G/SD 50×62×5
	1	60	1	CR 50×65×8 CRW1 R
52	0,6	64	0,6	CR 52×68×8 CRW1 R
	0,6	64	0,6	–
	0,6	64	0,6	–
	0,6	64	0,6	–
55	0,6	64	0,6	–
	0,6	64	0,6	–
	1	67	1	CR 55×72×8 CRW1 R
58	0,6	68	0,6	CR 58×72×8 CRW1 R
	0,6	68	0,6	–
	0,6	68	0,6	–
	0,6	68	0,6	–
60	0,6	68	0,6	–
	0,6	68	0,6	–
	1,1	73,5	1	–
63	1	75	1	CR 63×80×8 CRW1 R
	1	75	1	–
65	0,6	74	0,6	–
	0,6	74	0,6	–
	1,1	78,5	1	CR 65×85×8 CRW1 R
68	0,6	78	0,6	–
	0,6	78	0,6	–
	1	80	1	CR 68×85×8 CRW1 R
	1	80	1	–

¹⁾ For additional information, refer to the section *Radial shaft seals with a low cross sectional height*, starting on **page 208**.
For additional information about SKF seals, refer to the SKF catalogue *Industrial shaft seals*.

Needle roller bearings with machined rings with flanges, without an inner ring

F_w 70 – 100 mm

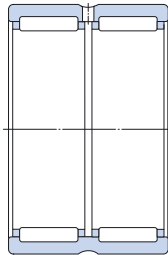
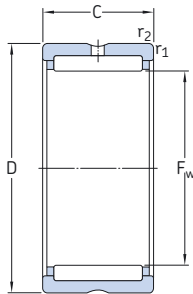

NK(S)
RNA 49

RNA 69

Principal dimensions			Basic load ratings		Fatigue load limit P_u	Speed ratings		Mass	Designation
F_w	D	C	dynamic	static		Reference speed	Limiting speed		
mm			C	C_0	kN	r/min	kg	–	
70	85	25	44,6	98	12,5	6 000	6 700	0,26	NK 70/25 NK 70/35 NKS 70
	85	35	61,6	150	19,6	6 000	6 700	0,37	
	90	28	68,2	120	15,6	5 600	6 300	0,38	
72	90	25	61,6	120	15,3	5 600	6 300	0,31	RNA 4913 RNA 6913
	90	45	95,2	212	27	5 600	6 300	0,58	
73	90	25	52,8	106	13,7	5 600	6 300	0,30	NK 73/25 NK 73/35
	90	35	73,7	163	21,6	5 600	6 300	0,43	
75	92	25	53,9	110	14	5 300	6 000	0,32	NK 75/25 NK 75/35 NKS 75
	92	35	74,8	170	22	5 300	6 000	0,45	
	95	28	70,4	132	17	5 300	6 000	0,40	
80	95	25	56,1	127	16	5 000	5 600	0,30	NK 80/25 NK 80/35 RNA 4914 RNA 6914
	95	35	76,5	190	25	5 000	5 600	0,43	
	100	30	84,2	163	21,6	5 000	5 600	0,46	
	100	54	128	285	37,5	5 000	5 600	0,86	
85	105	25	69,3	132	17	4 800	5 300	0,43	NK 85/25 RNA 4915 NK 85/35 RNA 6915
	105	30	84,2	170	22,4	4 800	5 300	0,49	
	105	35	96,8	200	27	4 800	5 300	0,60	
	105	54	130	290	38	4 800	5 300	0,94	
90	110	25	72,1	140	18,3	4 500	5 000	0,45	NK 90/25 RNA 4916 NK 90/35 RNA 6916
	110	30	88	183	24	4 500	5 000	0,52	
	110	35	101	216	29	4 500	5 000	0,63	
	110	54	134	315	41,5	4 500	5 000	0,99	
95	115	26	73,7	146	19	4 300	4 800	0,49	NK 95/26 NK 95/36
	115	36	105	232	30,5	4 300	4 800	0,68	
100	120	26	76,5	156	19,6	4 000	4 500	0,52	NK 100/26 RNA 4917 NK 100/36 RNA 6917
	120	35	108	250	32	4 000	4 500	0,66	
	120	36	108	250	32	4 000	4 500	0,72	
	120	63	165	425	54	4 000	4 500	1,20	

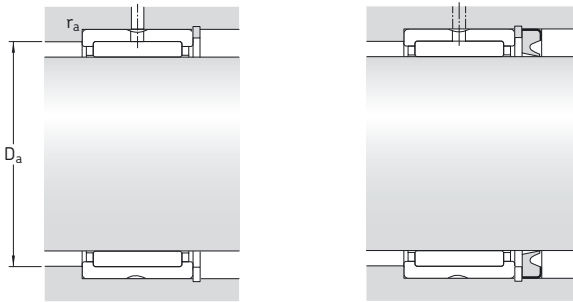

Dimensions		Abutment and fillet dimensions		Appropriate seal ¹⁾ Designation
F _w	r _{1,2} min	D _a max	r _a max	
mm		mm		–
70	0,6	81	0,6	CR 70×85×8 CRW1 R
	0,6	81	0,6	CR 70×85×8 CRW1 R
	1,1	83,5	1	CR 70×95×10 CRW1 R
72	1	85	1	CR 72×90×10 CRSH1 R
	1	85	1	–
73	1	85	1	–
	1	85	1	–
75	1	87	1	–
	1	87	1	–
	1,1	88,5	1	CR 75×95×10 CRW1 R
80	1	90	1	–
	1	90	1	–
	1	95	1	CR 80×100×10 CRW1 R
	1	95	1	–
85	1	100	1	CR 85×105×10 CRW1 R
	1	100	1	CR 85×105×10 CRW1 R
	1	100	1	CR 85×105×10 CRW1 R
	1	100	1	–
90	1	105	1	CR 90×110×12 CRW1 R
	1	105	1	CR 90×110×12 CRW1 R
	1	105	1	CR 90×110×12 CRW1 R
	1	105	1	–
95	1	110	1	CR 95×115×12 CRW1 R
	1	110	1	CR 95×115×12 CRW1 R
100	1	115	1	CR 100×120×12 CRW1 R
	1,1	113,5	1	CR 100×120×12 CRW1 R
	1	115	1	CR 100×120×12 CRW1 R
	1,1	113,5	1	–

¹⁾ For additional information, refer to the section *Radial shaft seals with a low cross sectional height*, starting on **page 208**.
For additional information about SKF seals, refer to the SKF catalogue *Industrial shaft seals*.

Needle roller bearings with machined rings with flanges, without an inner ring
 F_w 105 – 210 mm

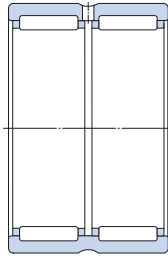
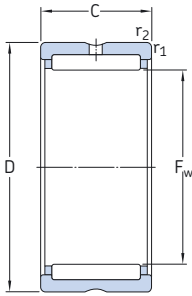

NK
RNA 48
RNA 49

RNA 69

Principal dimensions			Basic load ratings		Fatigue load limit P_u	Speed ratings		Mass	Designation
F_w	D	C	dynamic	static		Reference speed	Limiting speed		
mm			kN		kN	r/min		kg	–
105	125	26	78,1	166	20,8	3 800	4 300	0,54	NK 105/26 RNA 4918 NK 105/36 RNA 6918
	125	35	112	265	33,5	3 800	4 300	0,75	
	125	36	112	265	33,5	3 800	4 300	0,71	
	125	63	172	450	57	3 800	4 300	1,35	
110	130	30	96,8	220	27,5	3 600	4 000	0,65	NK 110/30 RNA 4919 NK 110/40 RNA 6919
	130	35	114	270	34	3 600	4 000	0,72	
	130	40	123	305	38	3 600	4 000	0,83	
	130	63	172	465	57	3 600	4 000	1,45	
115	140	40	125	280	34,5	3 400	4 000	1,15	RNA 4920
120	140	30	93,5	232	27,5	3 400	3 800	0,67	RNA 4822
125	150	40	130	300	36,5	3 200	3 600	1,25	RNA 4922
130	150	30	99	255	30	3 200	3 600	0,73	RNA 4824
135	165	45	176	405	47,5	3 000	3 400	1,85	RNA 4924
145	165	35	119	325	37,5	2 800	3 200	0,99	RNA 4826
150	180	50	198	480	55	2 600	3 000	2,20	RNA 4926
155	175	35	121	345	38	2 600	3 000	1,05	RNA 4828
160	190	50	205	510	58,5	2 400	2 800	2,35	RNA 4928
165	190	40	147	415	46,5	2 400	2 800	1,60	RNA 4830
175	200	40	157	450	50	2 200	2 600	1,70	RNA 4832
185	215	45	179	520	57	2 200	2 400	2,55	RNA 4834
195	225	45	190	570	60	2 000	2 400	2,70	RNA 4836
210	240	50	220	710	73,5	1 900	2 200	3,20	RNA 4838

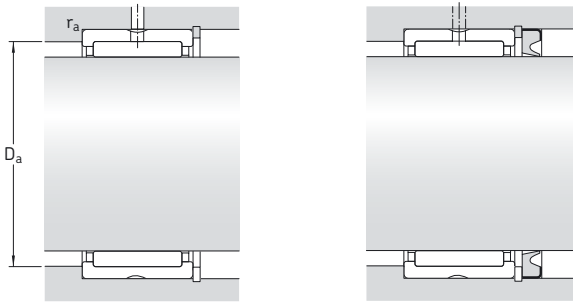

Dimensions		Abutment and fillet dimensions		Appropriate seal ¹⁾
F _w	r _{1,2} min	D _a max	r _a max	Designation
mm		mm		–
105	1	120	1	–
	1,1	118,5	1	–
	1	120	1	–
	1,1	118,5	1	–
110	1,1	123,5	1	CR 110×130×12 CRW1 R
	1,1	123,5	1	–
	1,1	123,5	1	CR 110×130×12 CRW1 R
	1,1	123,5	1	–
115	1,1	133,5	1	CR 115×140×12 CRW1 R
120	1	135	1	CR 120×140×13 HMS4 R
125	1,1	143,5	1	CR 125×150×12 CRW1 R
130	1	145	1	–
135	1,1	158,5	1	–
145	1,1	158,5	1	CR 145×165×13 CRSH1 R
150	1,5	172	1,5	CR 150×180×12 HMS4 R
155	1,1	168,5	1	–
160	1,5	182	1,5	CR 160×190×15 CRW1 V
165	1,1	183,5	1	–
175	1,1	193,5	1	–
185	1,1	208,5	1	–
195	1,1	218,5	1	–
210	1,5	232	1,5	–

¹⁾ For additional information, refer to the section *Radial shaft seals with a low cross sectional height*, starting on **page 208**.
For additional information about SKF seals, refer to the SKF catalogue *Industrial shaft seals*.

Needle roller bearings with machined rings with flanges, without an inner ring
F_w 220 – 415 mm

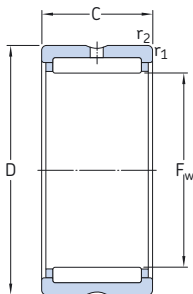

RNA 48

Principal dimensions			Basic load ratings		Fatigue load limit P _u	Speed ratings		Mass	Designation
F _w	D	C	dynamic	static		Reference speed	Limiting speed		
mm			kN		kN	r/min		kg	–
220	250	50	224	735	75	1 800	2 000	3,35	RNA 4840
240	270	50	238	815	81,5	1 700	1 900	3,60	RNA 4844
265	300	60	347	1 120	108	1 500	1 700	5,40	RNA 4848
285	320	60	358	1 200	114	1 400	1 500	5,80	RNA 4852
305	350	69	429	1 320	127	1 300	1 400	9,30	RNA 4856
330	380	80	594	1 800	170	1 100	1 300	12,5	RNA 4860
350	400	80	605	1 900	176	1 100	1 200	13,5	RNA 4864
370	420	80	616	1 960	180	1 000	1 200	14,0	RNA 4868
390	440	80	627	2 040	186	950	1 100	15,0	RNA 4872
415	480	100	968	3 000	265	900	1 000	26,0	RNA 4876

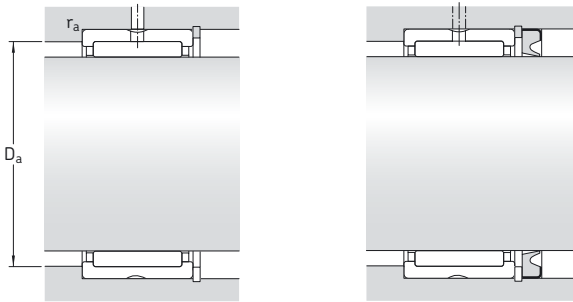

Dimensions		Abutment and fillet dimensions		Appropriate seal ¹⁾ Designation
F_w	$r_{1,2}$ min	D_a max	r_a max	
mm		mm		–
220	1,5	242	1,5	CR 220×250×15 HMS4 R
240	1,5	262	1,5	CR 240×270×16 HDS1 R
265	2	291	2	–
285	2	311	2	–
305	2	341	2	–
330	2,1	369	2	–
350	2,1	389	2	CR 350×400×17 HDS1 R
370	2,1	409	2	CR 370×420×25 HDS1 R
390	2,1	429	2	–
415	2,1	469	2	–

¹⁾ For additional information, refer to the section *Radial shaft seals with a low cross sectional height*, starting on page 208. For additional information about SKF seals, refer to the SKF catalogue *Industrial shaft seals*.

Needle roller bearings with machined rings with flanges, with an inner ring
d 5 – 17 mm

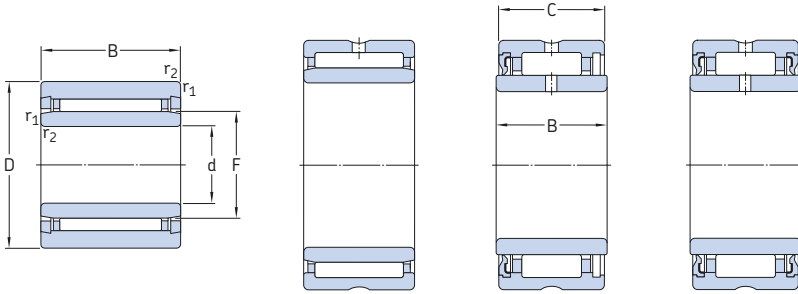

NKL (d ≤ 7 mm)

NKL(S) (d ≥ 9 mm)
 NA 49
 NA 69

NA 49..RS

NA 49...2RS

Principal dimensions				Basic load ratings		Fatigue load limit	Speed ratings		Mass	Designation
d	D	B	C	C	C ₀	P _u	Reference speed	Limiting speed		
mm				kN		kN	r/min		kg	–
5	15	12	–	3,8	4,25	0,465	32 000	36 000	0,012	NKI 5/12 TN
	15	16	–	5,01	5,85	0,67	32 000	36 000	0,015	NKI 5/16 TN
6	16	12	–	4,4	5,2	0,57	30 000	34 000	0,014	NKI 6/12 TN
	16	16	–	5,72	7,2	0,815	30 000	34 000	0,017	NKI 6/16 TN
7	17	12	–	4,57	5,7	0,63	28 000	32 000	0,014	NKI 7/12 TN
	17	16	–	5,94	8	0,9	28 000	32 000	0,018	NKI 7/16 TN
9	19	12	–	6,71	8,15	0,965	26 000	30 000	0,017	NKI 9/12
	19	16	–	9,13	12	1,46	26 000	30 000	0,022	NKI 9/16
10	22	13	–	8,8	10,4	1,25	24 000	28 000	0,023	NA 4900
	22	14	13	7,37	8,15	0,95	13 000	12 000	0,025	NA 4900 RS
	22	14	13	7,37	8,15	0,95	–	12 000	0,025	NA 4900.2RS
	22	16	–	10,2	12,5	1,53	24 000	28 000	0,029	NKI 10/16
	22	20	–	12,8	16,6	2,08	24 000	28 000	0,037	NKI 10/20
12	24	13	–	9,9	12,2	1,46	22 000	26 000	0,026	NA 4901
	24	14	13	8,09	9,65	1,14	22 000	11 000	0,028	NA 4901 RS
	24	14	13	8,09	9,65	1,14	–	11 000	0,028	NA 4901.2RS
	24	16	–	11,7	15,3	1,86	22 000	26 000	0,033	NKI 12/16
	24	20	–	14,5	20	2,5	22 000	26 000	0,042	NKI 12/20
	24	22	–	16,1	23,2	2,9	22 000	26 000	0,046	NA 6901
15	27	16	–	13,4	19	2,32	20 000	24 000	0,039	NKI 15/16
	27	20	–	16,5	25,5	3,2	20 000	24 000	0,049	NKI 15/20
	28	13	–	11,2	15,3	1,83	19 000	22 000	0,034	NA 4902
	28	14	13	9,13	12	1,4	19 000	9 500	0,037	NA 4902 RS
	28	14	13	9,13	12	1,4	–	9 500	0,037	NA 4902.2RS
	28	23	–	17,2	27	3,4	19 000	22 000	0,064	NA 6902
	35	20	–	24,6	30	3,9	16 000	19 000	0,092	NKIS 15
17	29	16	–	13,8	20,4	2,5	19 000	22 000	0,042	NKI 17/16
	29	20	–	17,2	27	3,45	19 000	22 000	0,053	NKI 17/20
	30	13	–	11,4	16,3	1,96	18 000	20 000	0,037	NA 4903
	30	14	13	9,52	12,9	1,5	18 000	9 000	0,040	NA 4903 RS
	30	14	13	9,52	12,9	1,5	–	9 000	0,040	NA 4903.2RS
	30	23	–	18,7	30,5	3,9	18 000	20 000	0,072	NA 6903
	37	20	–	26	33,5	4,25	15 000	17 000	0,098	NKIS 17

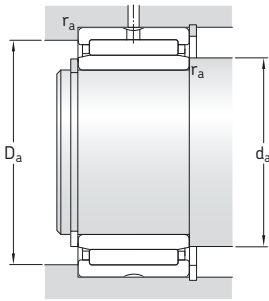

Dimensions

Abutment and fillet dimensions

d	F	r _{1,2} min	s ¹⁾	d _a min	D _a max	r _a max
mm				mm		
5	8	0,3	1,5	7	13	0,3
	8	0,3	2	7	13	0,3
6	9	0,3	1,5	8	14	0,3
	9	0,3	2	8	14	0,3
7	10	0,3	1,5	9	15	0,3
	10	0,3	2	9	15	0,3
9	12	0,3	1,5	11	17	0,3
	12	0,3	2	11	17	0,3
10	14	0,3	0,5	12	20	0,3
	14	0,3	0,5	12	20	0,3
	14	0,3	0,5	12	20	0,3
	14	0,3	0,5	12	20	0,3
	14	0,3	0,5	12	20	0,3
12	16	0,3	0,5	14	22	0,3
	16	0,3	0,5	14	22	0,3
	16	0,3	0,5	14	22	0,3
	16	0,3	0,5	14	22	0,3
	16	0,3	0,5	14	22	0,3
	16	0,3	1	14	22	0,3
15	19	0,3	0,5	17	25	0,3
	19	0,3	0,5	17	25	0,3
	20	0,3	0,5	17	26	0,3
	20	0,3	0,5	17	26	0,3
	20	0,3	0,5	17	26	0,3
	20	0,3	1	17	26	0,3
	22	0,6	0,5	19	31	0,6
17	21	0,3	0,5	19	27	0,3
	21	0,3	0,5	19	27	0,3
	22	0,3	0,5	19	28	0,3
	22	0,3	0,5	19	28	0,3
	22	0,3	0,5	19	28	0,3
	22	0,3	1	19	28	0,3
	24	0,6	0,5	21	33	0,6

¹⁾ Permissible axial displacement from normal position of one bearing ring relative to the other

Needle roller bearings with machined rings with flanges, with an inner ring
d 20 – 32 mm

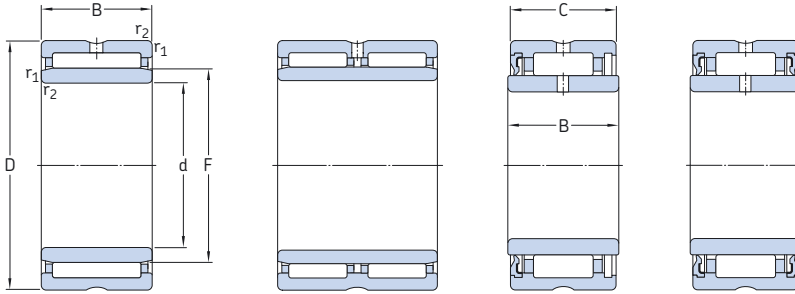

NKI(S)
 NA 49
 NA 69 (D < 47 mm)

NA 69 (D ≥ 52 mm)

NA 49..RS

NA 49...2RS

Principal dimensions				Basic load ratings		Fatigue load limit	Speed ratings		Mass	Designation
d	D	B	C	C	C ₀	P _U	Reference speed	Limiting speed		
mm				kN		kN	r/min		kg	–
20	32	16	–	15,4	24,5	3	16 000	19 000	0,049	NKI 20/16
	32	20	–	19	32,5	4,05	16 000	19 000	0,061	NKI 20/20
	37	17	–	21,6	28	3,55	15 000	17 000	0,075	NA 4904
	37	18	17	19,4	22,4	2,75	15 000	7 500	0,080	NA 4904 RS
	37	18	17	19,4	22,4	2,75	–	7 500	0,080	NA 4904.2RS
	37	30	–	35,2	53	6,95	15 000	17 000	0,14	NA 6904
	42	20	–	28,6	39	5	13 000	15 000	0,13	NKI 20
	22	34	16	–	15,7	26	3,2	15 000	17 000	0,052
34		20	–	19,4	34,5	4,3	15 000	17 000	0,065	NKI 22/20
39		17	–	23,3	32	4,05	14 000	15 000	0,080	NA 49/22
39		30	–	36,9	57	7,5	14 000	15 000	0,15	NA 69/22
25		38	20	–	24,6	42,5	5,2	14 000	15 000	0,076
	38	30	–	31,9	60	7,8	14 000	15 000	0,12	NKI 25/30
	42	17	–	24,2	34,5	4,3	13 000	15 000	0,088	NA 4905
	42	18	17	21,6	27,5	3,35	13 000	6 300	0,090	NA 4905 RS
	42	18	17	21,6	27,5	3,35	–	6 300	0,090	NA 4905.2RS
	42	30	–	38	62	8,15	13 000	15 000	0,16	NA 6905
	47	22	–	34,1	46,5	6	12 000	13 000	0,16	NKI 25
	28	42	20	–	26,4	48	6	12 000	14 000	0,093
42		30	–	34,1	65,5	8,65	12 000	14 000	0,15	NKI 28/30
45		17	–	25,1	36,5	4,55	12 000	14 000	0,098	NA 49/28
45		30	–	39,6	65,5	8,65	12 000	14 000	0,18	NA 69/28
30	45	20	–	27,5	52	6,55	11 000	13 000	0,11	NKI 30/20 TN
	45	30	–	40,2	85	10,6	11 000	13 000	0,17	NKI 30/30 TN
	47	17	–	25,5	39	4,9	11 000	13 000	0,10	NA 4906
	47	18	17	23,3	32	3,9	11 000	5 600	0,10	NA 4906 RS
	47	18	17	23,3	32	3,9	–	5 600	0,10	NA 4906.2RS
	47	30	–	42,9	75	9,8	11 000	13 000	0,19	NA 6906
	52	22	–	36	54	6,95	10 000	12 000	0,18	NKI 30
	32	47	20	–	25,1	46,5	5,85	11 000	12 000	0,12
47		30	–	36,9	76,5	10	11 000	12 000	0,18	NKI 32/30
52		20	–	30,8	51	6,55	10 000	11 000	0,16	NA 49/32
52		36	–	47,3	90	11,2	10 000	11 000	0,29	NA 69/32

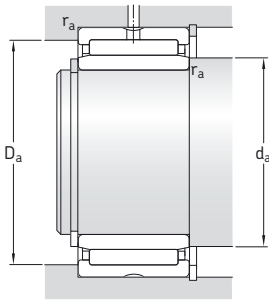

Dimensions

Abutment and fillet dimensions

d	F	$r_{1,2}$ min	$s^1)$	d_a min	D_a max	r_a max
mm				mm		
20	24	0,3	0,5	22	30	0,3
	24	0,3	0,5	22	30	0,3
	25	0,3	0,8	22	35	0,3
	25	0,3	0,5	22	35	0,3
	25	0,3	0,5	22	35	0,3
	25	0,3	1	22	35	0,3
	28	0,6	0,5	24	38	0,6
22	26	0,3	0,5	24	32	0,3
	26	0,3	0,5	24	32	0,3
	28	0,3	0,8	24	37	0,3
	28	0,3	0,5	24	37	0,3
25	29	0,3	1	27	36	0,3
	29	0,3	1,5	27	36	0,3
	30	0,3	0,8	27	40	0,3
	30	0,3	0,5	27	40	0,3
	30	0,3	0,5	27	40	0,3
	30	0,3	1	27	40	0,3
	32	0,6	1	29	43	0,6
28	32	0,3	1	30	40	0,3
	32	0,3	1,5	30	40	0,3
	32	0,3	0,8	30	43	0,3
	32	0,3	1	30	43	0,3
30	35	0,3	0,5	32	43	0,3
	35	0,3	1	32	43	0,3
	35	0,3	0,8	32	45	0,3
	35	0,3	0,5	32	45	0,3
	35	0,3	0,5	32	45	0,3
	35	0,3	1	32	45	0,3
	37	0,6	1	34	48	0,6
32	37	0,3	0,5	34	45	0,3
	37	0,3	1	34	45	0,3
	40	0,6	0,8	36	48	0,6
	40	0,6	0,5	36	48	0,6

¹⁾ Permissible axial displacement from normal position of one bearing ring in relation to the other

Needle roller bearings with machined rings with flanges, with an inner ring
d 35 – 50 mm

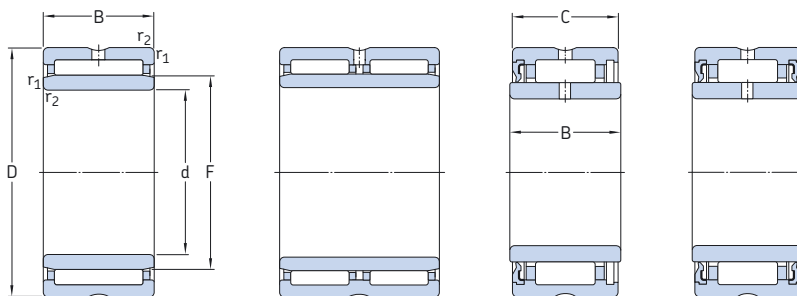

NKI(S)
NA 49

NA 69

NA 49..RS

NA 49...2RS

Principal dimensions				Basic load ratings		Fatigue load limit	Speed ratings		Mass	Designation
d	D	B	C	C	C ₀	P _U	Reference speed	Limiting speed		
mm				kN		kN	r/min		kg	–
35	50	20	–	30,3	61	7,5	10 000	11 000	0,13	NKI 35/20 TN
	50	30	–	38	83	10,8	10 000	11 000	0,19	NKI 35/30
	55	20	–	31,9	54	6,95	9 500	11 000	0,17	NA 4907
	55	21	20	27	43	5,4	9 500	5 400	0,18	NA 4907 RS
	55	21	20	27	43	5,4	–	5 400	0,18	NA 4907.2RS
	55	36	–	48,4	93	11,8	9 500	11 000	0,31	NA 6907
	58	22	–	39,1	61	7,8	9 000	10 000	0,22	NKIS 35
38	53	20	–	27,5	55	6,95	9 500	11 000	0,14	NKI 38/20
	53	30	–	40,2	90	11,6	9 500	11 000	0,21	NKI 38/30
40	55	20	–	31,4	67	8,3	9 000	10 000	0,14	NKI 40/20 TN
	55	30	–	45,7	108	13,4	9 000	10 000	0,22	NKI 40/30 TN
	62	22	–	42,9	71	9,15	8 000	9 500	0,23	NA 4908
	62	23	22	36,9	58,5	7,35	8 000	4 000	0,25	NA 4908 RS
	62	23	22	36,9	58,5	7,35	–	4 000	0,25	NA 4908.2RS
	62	40	–	67,1	125	16	8 000	9 500	0,43	NA 6908
	65	22	–	42,9	72	9,15	8 000	9 000	0,28	NKIS 40
42	57	20	–	29,2	61	7,65	8 500	10 000	0,15	NKI 42/20
	57	30	–	41,8	98	12,9	8 500	10 000	0,22	NKI 42/30
45	62	25	–	42,9	93	11,2	8 000	9 000	0,22	NKI 45/25 TN
	62	35	–	58,3	137	17	8 000	9 000	0,31	NKI 45/35 TN
	68	22	–	45,7	78	10	7 500	8 500	0,27	NA 4909
	68	23	22	39,1	64	8	7 500	3 800	0,29	NA 4909 RS
	68	23	22	39,1	64	8	–	3 800	0,29	NA 4909.2RS
	68	40	–	70,4	137	17,3	7 500	8 500	0,50	NA 6909
	72	22	–	44,6	78	10	7 000	8 000	0,34	NKIS 45
50	68	25	–	40,2	88	11,2	7 500	8 500	0,27	NKI 50/25
	68	35	–	52,3	122	16	7 500	8 500	0,38	NKI 50/35
	72	22	–	47,3	85	11	7 000	8 000	0,27	NA 4910
	72	23	22	40,2	69,5	8,8	7 000	3 400	0,30	NA 4910 RS
	72	23	22	40,2	69,5	8,8	–	3 400	0,30	NA 4910.2RS
	72	40	–	73,7	150	19	7 000	8 000	0,52	NA 6910
	80	28	–	62,7	104	13,7	6 300	7 500	0,52	NKIS 50

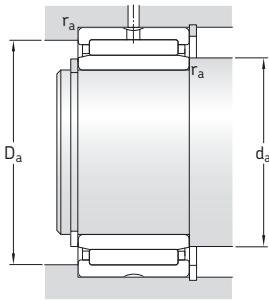

Dimensions

Abutment and fillet dimensions

d	F	$r_{1,2}$ min	$s^1)$	d_a min	D_a max	r_a max
mm				mm		
35	40	0,3	0,5	37	48	0,3
	40	0,3	1	37	48	0,3
	42	0,6	0,8	39	51	0,6
	42	0,6	0,5	39	51	0,6
	42	0,6	0,5	39	51	0,6
	42	0,6	0,5	39	51	0,6
	43	0,6	0,5	39	54	0,6
38	43	0,3	0,5	40	51	0,3
	43	0,3	1	40	51	0,3
40	45	0,3	0,5	42	53	0,3
	45	0,3	1	42	53	0,3
	48	0,6	1	44	58	0,6
	48	0,6	0,5	44	58	0,6
	48	0,6	0,5	44	58	0,6
	48	0,6	0,5	44	58	0,6
	50	1	0,5	45	60	1
42	47	0,3	0,5	44	55	0,3
	47	0,3	1	44	55	0,3
45	50	0,6	1,5	49	58	0,6
	50	0,6	2	49	58	0,6
	52	0,6	1	49	64	0,6
	52	0,6	0,5	49	64	0,6
	52	0,6	0,5	49	64	0,6
	52	0,6	0,5	49	64	0,6
	55	1	0,5	50	67	1
50	55	0,6	1,5	54	64	0,6
	55	0,6	2	54	64	0,6
	58	0,6	1	54	68	0,6
	58	0,6	0,5	54	68	0,6
	58	0,6	0,5	54	68	0,6
	58	0,6	0,5	54	68	0,6
	58	0,6	0,5	54	68	0,6
	60	1,1	2	56,5	73,5	1

¹⁾ Permissible axial displacement from normal position of one bearing ring in relation to the other

Needle roller bearings with machined rings with flanges, with an inner ring
d 55 – 85 mm

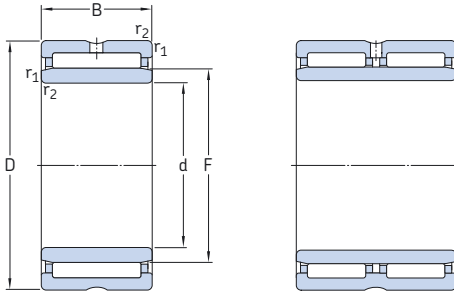

NKI(S)
NA 49

NA 69

Principal dimensions			Basic load ratings		Fatigue load limit	Speed ratings		Mass	Designation
d	D	B	dynamic	static		Reference speed	Limiting speed		
mm			C	C ₀	P _u	r/min		kg	–
55	72	25	46,8	110	13,4	6 700	7 500	0,26	NKI 55/25 TN
	72	35	55	134	17,6	6 700	7 500	0,38	NKI 55/35
	80	25	57,2	106	13,7	6 300	7 000	0,39	NA 4911
	80	45	89,7	190	24	6 300	7 000	0,78	NA 6911
	85	28	66	114	15	6 000	6 700	0,56	NKIS 55
60	82	25	44	95	12	6 000	6 700	0,39	NKI 60/25
	82	35	60,5	146	19	6 000	6 700	0,55	NKI 60/35
	85	25	60,5	114	14,6	6 000	6 700	0,43	NA 4912
	85	45	93,5	204	26	6 000	6 700	0,81	NA 6912
	90	28	68,2	120	15,6	5 600	6 300	0,56	NKIS 60
65	90	25	61,6	120	15,3	5 600	6 300	0,46	NA 4913
	90	25	52,8	106	13,7	5 600	6 300	0,47	NKI 65/25
	90	35	73,7	163	21,6	5 600	6 300	0,66	NKI 65/35
	90	45	95,2	212	27	5 600	6 300	0,83	NA 6913
	95	28	70,4	132	17	5 300	6 000	0,64	NKIS 65
70	95	25	56,1	127	16	5 000	5 600	0,52	NKI 70/25
	95	35	76,5	190	25	5 000	5 600	0,74	NKI 70/35
	100	30	84,2	163	21,6	5 000	5 600	0,73	NA 4914
	100	54	128	285	37,5	5 000	5 600	1,35	NA 6914
75	105	25	69,3	132	17	4 800	5 300	0,64	NKI 75/25
	105	30	84,2	170	22,4	4 800	5 300	0,78	NA 4915
	105	35	96,8	200	27	4 800	5 300	0,91	NKI 75/35
	105	54	130	290	38	4 800	5 300	1,45	NA 6915
80	110	25	72,1	140	18,3	4 500	5 000	0,68	NKI 80/25
	110	30	88	183	24	4 500	5 000	0,88	NA 4916
	110	35	101	216	29	4 500	5 000	0,96	NKI 80/35
	110	54	134	315	41,5	4 500	5 000	1,50	NA 6916
85	115	26	73,7	146	19	4 300	4 800	0,74	NKI 85/26
	115	36	105	232	30,5	4 300	4 800	1,05	NKI 85/36
	120	35	108	250	32	4 000	4 500	1,25	NA 4917
	120	63	165	425	54	4 000	4 500	2,20	NA 6917

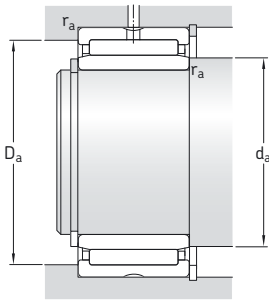

Dimensions

Abutment and fillet dimensions

d	F	r _{1,2} min	s ¹⁾	d _a min	D _a max	r _a max
mm				mm		
55	60	0,6	1,5	59	68	0,6
	60	0,6	2	59	68	0,6
	63	1	1,5	60	75	1
	63	1	1,5	60	75	1
	65	1,1	2	61,5	78,5	1
60	68	0,6	1	64	78	0,6
	68	0,6	1	64	78	0,6
	68	1	1,5	65	80	1
	68	1	1,5	65	80	1
	70	1,1	2	66,5	83,5	1
65	72	1	1,5	70	85	1
	73	1	1	70	85	1
	73	1	1	70	85	1
	72	1	1,5	70	85	1
	75	1,1	2	71,5	88,5	1
70	80	1	0,8	75	90	1
	80	1	0,8	75	90	1
	80	1	1,5	75	95	1
	80	1	1	75	95	1
75	85	1	1	80	100	1
	85	1	1,5	80	100	1
	85	1	1	80	100	1
	85	1	1	80	100	1
80	90	1	1	85	105	1
	90	1	1,5	85	105	1
	90	1	1	85	105	1
	90	1	1	85	105	1
85	95	1	1,5	90	110	1
	95	1	1,5	90	110	1
	100	1,1	1	91,5	113,5	1
	100	1,1	1	91,5	113,5	1

¹⁾ Permissible axial displacement from normal position of one bearing ring in relation to the other

Needle roller bearings with machined rings with flanges, with an inner ring
d 90 – 220 mm

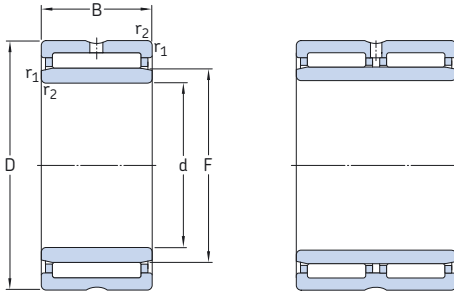

NKI
 NA 48
 NA 49

NA 69

Principal dimensions			Basic load ratings		Fatigue load limit	Speed ratings		Mass	Designation
d	D	B	dynamic	static		Reference speed	Limiting speed		
mm			C	C ₀	P _u	r/min		kg	–
90	120	26	76,5	156	19,6	4 000	4 500	0,78	NKI 90/26
	120	36	108	250	32	4 000	4 500	1,10	NKI 90/36
	125	35	112	265	33,5	3 800	4 300	1,30	NA 4918
	125	63	172	450	57	3 800	4 300	2,30	NA 6918
95	125	26	78,1	166	20,8	3 800	4 300	0,82	NKI 95/26
	125	36	112	265	33,5	3 800	4 300	1,15	NKI 95/36
	130	35	114	270	34	3 600	4 000	1,35	NA 4919
	130	63	172	465	57	3 600	4 000	2,50	NA 6919
100	130	30	96,8	220	27,5	3 600	4 000	0,99	NKI 100/30
	130	40	123	305	38	3 600	4 000	1,35	NKI 100/40
	140	40	125	280	34,5	3 400	4 000	1,90	NA 4920
110	140	30	93,5	232	27,5	3 400	3 800	1,10	NA 4822
	150	40	130	300	36,5	3 200	3 600	2,05	NA 4922
120	150	30	99	255	30	3 200	3 600	1,15	NA 4824
	165	45	176	405	47,5	3 000	3 400	2,85	NA 4924
130	165	35	119	325	37,5	2 800	3 200	1,80	NA 4826
	180	50	198	480	55	2 600	3 000	3,90	NA 4926
140	175	35	121	345	38	2 600	3 000	1,90	NA 4828
	190	50	205	510	58,5	2 400	2 800	4,15	NA 4928
150	190	40	147	415	46,5	2 400	2 800	2,70	NA 4830
160	200	40	157	450	50	2 200	2 600	2,90	NA 4832
170	215	45	179	520	57	2 200	2 400	3,95	NA 4834
180	225	45	190	570	60	2 000	2 400	4,20	NA 4836
190	240	50	220	710	73,5	1 900	2 200	5,60	NA 4838
200	250	50	224	735	75	1 800	2 000	5,85	NA 4840
220	270	50	238	815	81,5	1 700	1 900	6,40	NA 4844

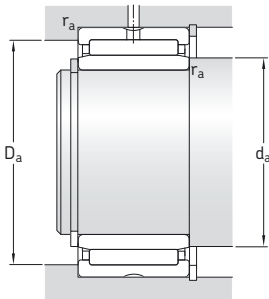

Dimensions

Abutment and fillet dimensions

d	F	r _{1,2} min	s ¹⁾	d _a min	D _a max	r _a max
mm			mm			
90	100	1	1,5	95	115	1
	100	1	1,5	95	115	1
	105	1,1	1	96,5	118,5	1
	105	1,1	1	96,5	118,5	1
95	105	1	1,5	100	120	1
	105	1	1,5	100	120	1
	110	1,1	1	101,5	123,5	1
	110	1,1	1	101,5	123,5	1
100	110	1,1	1,5	106,5	123,5	1
	110	1,1	2	106,5	123,5	1
	115	1,1	2	106,5	133,5	1
110	120	1	0,8	115	135	1
	125	1,1	2	116,5	143,5	1
120	130	1	0,8	125	145	1
	135	1,1	2	126,5	158,5	1
130	145	1,1	1	136,5	158,5	1
	150	1,5	1,5	138	172	1,5
140	155	1,1	1	146,5	168,5	1
	160	1,5	1,5	148	182	1,5
150	165	1,1	1,5	156,5	183,5	1
160	175	1,1	1,5	166,5	193,5	1
170	185	1,1	1,5	176,5	208,5	1
180	195	1,1	1,5	186,5	218,5	1
190	210	1,5	1,5	198	232	1,5
200	220	1,5	1,5	208	242	1,5
220	240	1,5	1,5	228	262	1,5

¹⁾ Permissible axial displacement from normal position of one bearing ring in relation to the other

Needle roller bearings with machined rings with flanges, with an inner ring
d 240 – 380 mm

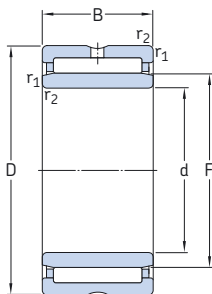

NA 48

Principal dimensions			Basic load ratings		Fatigue load limit	Speed ratings		Mass	Designation
d	D	B	dynamic	static		Reference speed	Limiting speed		
mm			kN		kN	r/min		kg	–
240	300	60	347	1 120	108	1 500	1 700	10,0	NA 4848
260	320	60	358	1 200	114	1 400	1 500	10,5	NA 4852
280	350	69	429	1 320	127	1 300	1 400	15,5	NA 4856
300	380	80	594	1 800	170	1 100	1 300	22,0	NA 4860
320	400	80	605	1 900	176	1 100	1 200	23,0	NA 4864
340	420	80	616	1 960	180	1 000	1 200	24,0	NA 4868
360	440	80	627	2 040	186	950	1 100	25,5	NA 4872
380	480	100	968	3 000	265	900	1 000	42,5	NA 4876

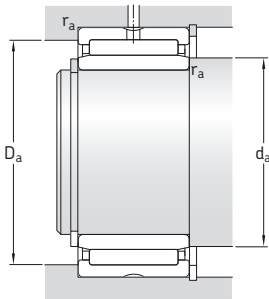

Dimensions

Abutment and fillet dimensions

d	F	$r_{1,2}$ min	$s^1)$	d_a min	D_a max	r_a max
mm				mm		
240	265	2	2	249	291	2
260	285	2	2	269	311	2
280	305	2	2,5	289	341	2
300	330	2,1	2	311	369	2
320	350	2,1	2	331	389	2
340	370	2,1	2	351	409	2
360	390	2,1	2	371	429	2
380	415	2,1	2	391	469	2

¹⁾ Permissible axial displacement from normal position of one bearing ring in relation to the other

Needle roller bearings with machined rings without flanges, without an inner ring

F_w 5 – 30 mm

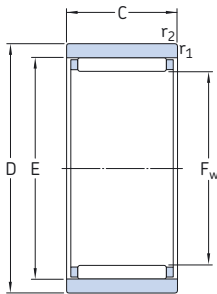

RNAO

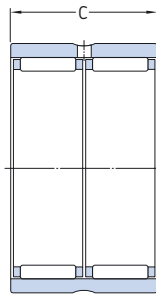

RNAO
(double row)

Principal dimensions			Basic load ratings		Fatigue load limit	Speed ratings		Mass	Designation
F_w	D	C	dynamic	static	P_u	Reference speed	Limiting speed		
mm			C	C_0	kN	r/min		kg	–
5	10	8	2,29	2	0,212	36 000	40 000	0,003	RNAO 5×10×8 TN
6	13	8	2,55	2,36	0,25	34 000	38 000	0,006	RNAO 6×13×8 TN
7	14	8	2,81	2,75	0,29	32 000	36 000	0,006	RNAO 7×14×8 TN
8	15	10	3,8	4,25	0,465	32 000	36 000	0,008	RNAO 8×15×10 TN
10	17	10	4,57	5,7	0,63	28 000	32 000	0,010	RNAO 10×17×10 TN
12	22	12	9,52	10	1,18	26 000	30 000	0,019	RNAO 12×22×12 TN
15	23	13	8,09	10,8	1,25	24 000	28 000	0,020	RNAO 15×23×13
16	24	13	8,58	12	1,37	24 000	26 000	0,021	RNAO 16×24×13
	28	12	11	12,5	1,5	22 000	26 000	0,032	RNAO 16×28×12
17	25	13	10,1	14,6	1,73	22 000	26 000	0,022	RNAO 17×25×13
18	30	24	20,9	30	3,6	20 000	24 000	0,069	RNAO 18×30×24 ¹⁾
20	28	13	9,52	14,6	1,66	20 000	22 000	0,025	RNAO 20×28×13
	28	26	16,1	29	3,35	20 000	22 000	0,050	RNAO 20×28×26 ¹⁾
	32	12	12,8	16,3	1,96	19 000	22 000	0,038	RNAO 20×32×12
22	30	13	10,1	16,3	1,86	18 000	20 000	0,027	RNAO 22×30×13
	35	16	19,4	25,5	3,05	17 000	19 000	0,059	RNAO 22×35×16
25	35	17	14,2	26,5	3,1	16 000	18 000	0,053	RNAO 25×35×17
	35	26	18,7	37,5	4,3	16 000	18 000	0,076	RNAO 25×35×26 ¹⁾
	37	16	20,1	28	3,35	15 000	17 000	0,060	RNAO 25×37×16
30	40	17	18,7	34	4,05	13 000	15 000	0,060	RNAO 30×40×17
	42	16	22	33,5	4	13 000	15 000	0,059	RNAO 30×42×16
	42	32	38	67	8	13 000	15 000	0,14	RNAO 30×42×32 ¹⁾

¹⁾ Double row, outer ring with a lubrication hole and an annular groove

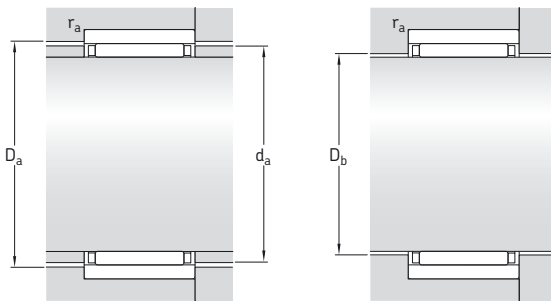

Dimensions

Abutment and fillet dimensions

F_w	E	$r_{1,2}$ min	d_a	D_a	D_b	r_a max
mm			mm			
5	8	0,15	7,7	8,3	5,3	0,1
6	9	0,3	8,7	9,3	6,3	0,3
7	10	0,3	9,7	10,3	7,3	0,3
8	11	0,3	10,7	11,3	8,3	0,3
10	13	0,3	12,7	13,3	10,3	0,3
12	18	0,3	17,6	18,3	12,3	0,3
15	19	0,3	18,6	19,3	15,4	0,3
16	20	0,3	19,6	20,3	16,4	0,3
	22	0,3	21,6	22,3	16,4	0,3
17	21	0,3	20,6	21,3	17,4	0,3
18	24	0,3	23,6	24,5	18,4	0,3
20	24	0,3	23,6	24,3	20,4	0,3
	24	0,3	23,6	24,3	20,4	0,3
	26	0,3	25,6	26,5	20,4	0,3
22	26	0,3	25,6	26,3	22,4	0,3
	29	0,3	28,4	29,5	22,4	0,3
25	30	0,3	29,4	30,5	25,6	0,3
	30	0,3	29,4	30,5	25,6	0,3
	32	0,3	31,4	32,5	25,6	0,3
30	35	0,3	34,4	35,5	30,6	0,3
	37	0,3	36,4	37,5	30,6	0,3
	37	0,3	36,4	37,5	30,6	0,3

Needle roller bearings with machined rings without flanges, without an inner ring

F_w 35 – 100 mm

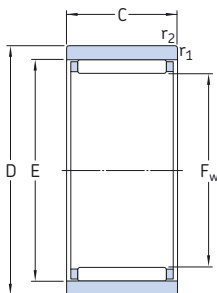

RNAO

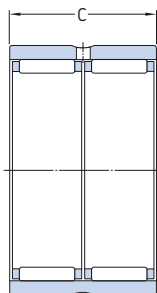

RNAO
(double row)

Principal dimensions			Basic load ratings		Fatigue load limit	Speed ratings		Mass	Designation
F_w	D	C	dynamic	static	P_u	Reference speed	Limiting speed		
mm			C	C_0	kN	r/min		kg	–
35	45	13	15,4	28	3,25	12 000	13 000	0,053	RNAO 35×45×13
	45	17	19,8	39	4,65	12 000	13 000	0,069	RNAO 35×45×17
	45	26	26,4	56	6,55	12 000	13 000	0,091	RNAO 35×45×26¹⁾
	47	16	23,3	37,5	4,5	11 000	13 000	0,078	RNAO 35×47×16
	47	18	26,4	44	5,3	11 000	13 000	0,089	RNAO 35×47×18
	47	32	40,2	75	9	11 000	13 000	0,16	RNAO 35×47×32¹⁾
40	50	17	20,5	41,5	5	10 000	12 000	0,074	RNAO 40×50×17
	50	34	35,2	83	10	10 000	12 000	0,15	RNAO 40×50×34¹⁾
	55	20	31,4	57	6,95	10 000	11 000	0,15	RNAO 40×55×20
	55	40	59,4	118	14,6	10 000	11 000	0,28	RNAO 40×55×40¹⁾
45	55	17	21,6	46,5	5,6	9 000	10 000	0,083	RNAO 45×55×17
	62	40	64,4	137	16,6	9 000	10 000	0,38	RNAO 45×62×40¹⁾
50	62	20	25,5	60	7,2	8 500	9 500	0,14	RNAO 50×62×20
	65	20	34,1	62	7,65	8 000	9 000	0,17	RNAO 50×65×20
	65	40	58,3	125	15,3	8 000	9 000	0,36	RNAO 50×65×40¹⁾
55	68	20	27	67	8,15	7 500	8 500	0,17	RNAO 55×68×20
60	78	20	41,8	86,5	10,6	6 700	7 500	0,26	RNAO 60×78×20
	78	40	72,1	173	21,2	6 700	7 500	0,44	RNAO 60×78×40¹⁾
65	85	30	53,9	125	15,6	6 300	7 000	0,46	RNAO 65×85×30
70	90	30	57,2	137	17	6 000	6 700	0,50	RNAO 70×90×30
80	100	30	68,2	176	22	5 000	6 000	0,58	RNAO 80×100×30
90	105	26	58,3	150	18,6	4 500	5 300	0,37	RNAO 90×105×26
	110	30	64,4	173	21,6	4 500	5 300	0,61	RNAO 90×110×30
100	120	30	67,1	190	23,6	4 000	4 800	0,69	RNAO 100×120×30

¹⁾ Double row, outer ring with a lubrication hole and an annular groove

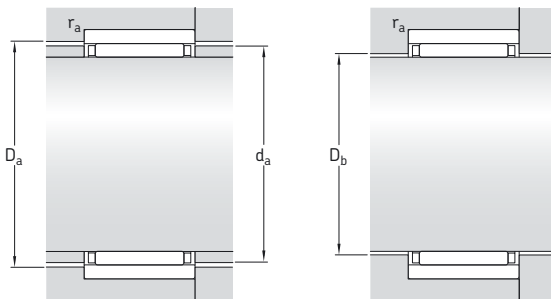
Dimensions
**Abutment and
fillet dimensions**

F_w	E	$r_{1,2}$ min	d_a	D_a	D_b	r_a max
mm		mm				
35	40	0,3	39,4	40,5	35,6	0,3
	40	0,3	39,4	40,5	35,6	0,3
	40	0,3	39,4	40,5	35,6	0,3
	42	0,3	41,4	42,5	35,8	0,3
	42	0,3	41,4	42,5	35,6	0,3
	42	0,3	41,4	42,5	35,6	0,3
40	45	0,3	44,4	45,5	40,6	0,3
	45	0,3	44,4	45,5	40,6	0,3
	47	0,3	46,2	47,5	40,6	0,3
	48	0,3	47,2	47,5	40,6	0,3
45	50	0,3	49,4	50,5	45,6	0,3
	53	0,3	52,2	53,5	46	0,3
50	55	0,3	54,4	55,8	50,6	0,3
	58	0,3	57,2	58,5	51	0,3
	58	0,3	57,2	58,5	51	0,3
55	60	0,3	59,4	60,8	55,6	0,3
60	68	1	67,2	68,8	61	1
	68	1	67,2	68,8	61	1
65	73	1	72,2	73,8	66	1
70	78	1	77,2	78,8	71	1
80	88	1	87,2	89	81	1
90	98	1	97,2	99	91	1
	98	1	97,2	99	91	1
100	108	1	107,2	109	101	1

Needle roller bearings with machined rings without flanges, with an inner ring
d 6 – 90 mm

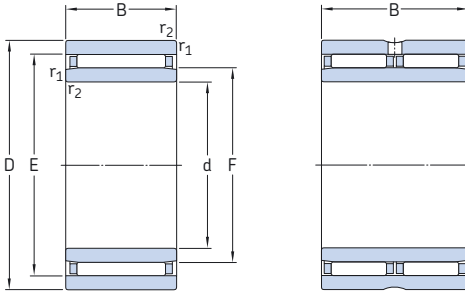

NAO

NAO
(double row)

Principal dimensions			Basic load ratings		Fatigue load limit	Speed ratings		Mass	Designation
d	D	B	dynamic	static		Reference speed	Limiting speed		
mm			C	C ₀	P _u	r/min	kg	–	
6	17	10	4,57	5,7	0,63	28 000	32 000	0,014	NAO 6×17×10 TN ²⁾
9	22	12	9,52	10	1,18	26 000	28 000	0,024	NAO 9×22×12 TN
12	24 28	13 12	8,58 11	12 12,5	1,37 1,5	24 000 22 000	26 000 26 000	0,030 0,040	NAO 12×24×13 NAO 12×28×12 ²⁾
15	28 32	13 12	9,52 12,8	14,6 16,3	1,66 1,96	20 000 19 000	22 000 22 000	0,029 0,050	NAO 15×28×13 NAO 15×32×12 ²⁾
17	30 35	13 16	10,1 19,4	16,3 25,5	1,86 3,05	18 000 17 000	20 000 19 000	0,042 0,078	NAO 17×30×13 NAO 17×35×16
20	35 37	17 16	14,2 20,1	26,5 28	3,1 3,35	16 000 15 000	18 000 17 000	0,076 0,082	NAO 20×35×17 NAO 20×37×16
25	40 42 42	17 16 32	18,7 22 38	34 33,5 68	4,05 4 8,15	13 000 13 000 12 000	15 000 15 000 14 000	0,088 0,086 0,19	NAO 25×40×17 NAO 25×42×16 ²⁾ NAO 25×42×32 ²⁾
30	45 45 47 47	17 26 16 18	19,8 26,4 23,3 26,4	39 56 37,5 44	4,65 6,55 4,5 5,3	12 000 12 000 11 000 11 000	13 000 13 000 13 000 13 000	0,10 0,16 0,11 0,12	NAO 30×45×17 NAO 30×45×26 ¹⁾ NAO 30×47×16 NAO 30×47×18
35	50 55	17 20	20,5 31,4	41,5 57	5 6,95	10 000 10 000	12 000 11 000	0,11 0,19	NAO 35×50×17 NAO 35×55×20
40	55	17	21,6	46,5	5,6	9 000	10 000	0,13	NAO 40×55×17
50	68	20	27	67	8,15	7 500	8 500	0,23	NAO 50×68×20 ²⁾
70	100	30	68,2	176	22	5 000	6 000	0,85	NAO 70×100×30
80	110	30	64,4	173	21,6	4 500	5 300	0,92	NAO 80×110×30
90	120	30	67,1	190	23,6	4 000	4 800	1,05	NAO 90×120×30

¹⁾ Double row, outer ring with a lubrication hole and an annular groove

²⁾ One lubrication hole in the inner ring

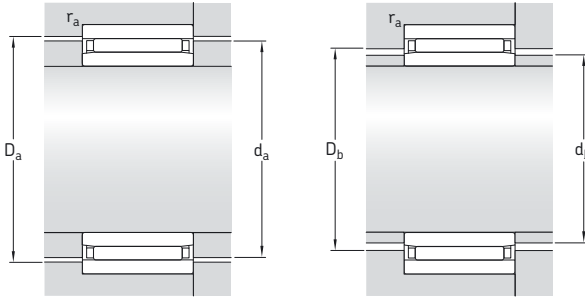

Dimensions

Abutment and fillet dimensions

d	E	F	r _{1,2} min	s ³⁾	d _a	d _b	D _a	D _b	r _a max
mm					mm			–	
6	13	10	0,3	0,5	12,7	9,7	13,3	10,3	0,3
9	18	12	0,3	0,5	17,6	11,7	18,3	12,3	0,3
12	20	16	0,3	0,5	19,6	15,7	20,3	16,4	0,3
	22	16	0,3	0,5	21,6	15,7	22,3	16,6	0,3
15	24	20	0,3	0,5	23,6	19,5	24,3	20,4	0,3
	26	20	0,3	0,5	25,6	19,5	26,5	20,6	0,3
17	26	22	0,3	0,5	25,6	21,5	26,3	22,4	0,3
	29	22	0,3	0,5	28,4	21,5	29,5	22,6	0,3
20	30	25	0,3	0,5	29,4	24,5	30,5	25,6	0,3
	32	25	0,3	0,5	31,4	24,5	32,5	25,6	0,3
25	35	30	0,3	0,8	34,4	29,5	35,5	30,6	0,3
	37	30	0,3	0,8	36,4	29,5	37,5	30,6	0,3
	37	30	0,3	0,8	36,4	29,5	37,5	30,6	0,3
30	40	35	0,3	0,8	39,4	34,5	40,5	35,6	0,3
	40	35	0,3	0,8	39,4	34,5	40,5	35,6	0,3
	42	35	0,3	0,8	41,4	34,5	42,5	35,6	0,3
	42	35	0,3	0,8	41,4	34,5	42,5	35,6	0,3
35	45	40	0,3	0,8	44,4	39,5	45,5	40,6	0,3
	48	40	0,3	0,8	46,2	39,5	47,5	40,6	0,3
40	50	45	0,3	0,8	49,2	44,5	50,5	45,6	0,3
50	60	55	0,6	1	59,2	54,5	60,8	55,8	0,6
70	88	80	1	1	87,2	79,3	89	81	1
80	98	90	1	1	97,2	89,3	99	91	1
90	108	100	1	1	107,2	99,3	109	101	1

³⁾ Permissible axial displacement from normal position of one bearing ring relative to the other



Alignment needle roller bearings

Dimensions	142
Tolerances	143
Internal clearance	143
Misalignment	143
Permissible operating temperature	143
Cages	144
Shaft and housing tolerances	144
Mounting instructions	145
Product tables	146
5.1 Alignment needle roller bearings without an inner ring.....	146
5.2 Alignment needle roller bearings with an inner ring.....	148

Alignment needle roller bearings

Alignment needle roller bearings have an outer ring with a convex sphered outside surface. Two polymer seating rings with a concave sphered inside surface that is encased in a drawn sheet steel sleeve are fitted over the outer ring, enabling the bearing to align itself. Alignment needle roller bearings are therefore insensitive to static misalignment of the shaft relative to the housing.

SKF supplies alignment needle roller bearings without an inner ring (→ **fig. 1**) and with an inner ring (→ **fig. 2**). Bearings without an inner ring provide the optimum solution for compact arrangements if the shaft can be hardened and ground. In applications where it is not possible or uneconomical to harden and grind the shaft, bearings with an inner ring should be used.

Bearings with an inner ring permit axial displacement of the shaft relative to the housing within certain limits (→ **product table**). If greater axial displacements are anticipated, extended inner rings that are wider than standard inner rings can be used.

See chapter *Needle roller bearing inner rings*, starting on **page 196**.

The bearings are supplied without grease and not sealed. Depending on the application, they can be grease or oil lubricated.

The ends of the needle rollers are slightly relieved. The resulting modified line contact between the rollers and raceways means that the load distribution in the bearing is improved.

Dimensions

The dimensions of alignment needle roller bearings have not been standardized. However, with the exception of bearings with a 52 mm outside diameter, the inner ring bore and outside diameter are standardized, in accordance with ISO 15:1998, as follows:

- bearings with an outside diameter $D \leq 47$ mm follow Diameter Series 0
- bearings with an outside diameter $D \geq 55$ mm follow Diameter Series 9

Fig. 1

Alignment needle roller bearing without an inner ring

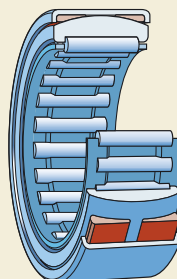

RPNA series

Fig. 2

Alignment needle roller bearing with an inner ring

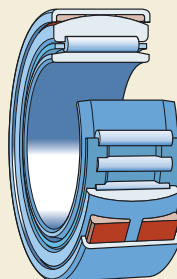

PNA series

Tolerances

Inner rings, as well as outer rings with a sphered outside surface are manufactured to Normal tolerances in accordance with ISO 492:2002.

The tolerance for the width of the external drawn sheet steel sleeve is $\pm 0,5$ mm.

Internal clearance

SKF alignment needle roller bearings with an inner ring have Normal radial internal clearance as standard. The clearance values are listed in **table 7** on **page 42** and are in accordance with ISO 5753:1991. They are valid for unmounted bearings under zero measuring load.

SKF alignment needle roller bearings without an inner ring have an inside diameter F_w that lies within F6 tolerance class when the bearing is unmounted and the rollers are in contact with the outer ring raceway. If the recommended tolerance classes (\rightarrow **table 1**) are applied, the operational clearance will reach a value in the range of C2 to Normal radial internal clearance (\rightarrow **table 7, page 42**).

Misalignment

Alignment needle roller bearings can compensate static misalignment up to 3° between the shaft and housing. These bearings are unable to accommodate any dynamic misalignment.

Permissible operating temperature

Due to the polymer seating ring material, the permissible operating temperature range for alignment needle roller bearings is -30 to $+100$ °C.

Table 1

Shaft and housing tolerance classes

Housing material	Tolerance classes		
	Housing bore seat	Shaft inner ring seat	Shaft raceway
Steel, cast iron	N6	k5	h5
	N7	j6	h6
Light alloy	R6	k5	h5
	R7	j6	h6

Cages

SKF alignment needle roller bearings are fitted with a machined steel (→ **fig. 3**) or a sheet steel cage (→ **fig. 4**), with adequate free space for lubricant.

Shaft and housing tolerances

Alignment needle roller bearings are mounted with an interference fit in the housing bore. Therefore, shoulders or snap rings are not required to locate the bearing axially so the design of the housing bore is simple and can be produced economically.

If the recommended housing bore tolerance classes listed in **table 1** on **page 143** are applied, alignment movements between the outer ring and the sleeve will be possible. These tolerances, together with the tolerance classes recommended for the inner ring shaft seats or for raceways on the shaft, will reach an operational clearance value in the range of C2 to Normal radial internal clearance (→ **table 7**, **page 42**).

Fig. 3

Machined steel cage

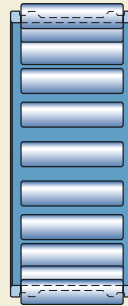
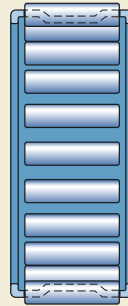

Fig. 4

Sheet steel cage



Mounting instructions

When mounting alignment needle roller bearings, the inner ring should be mounted separately. The outer ring and the polymer seating rings with sleeve and needle roller and cage assembly should be mounted with a mounting dolly (→ **fig. 5**). An O-ring provides a simple means of retaining the bearing on the mounting dolly. The stamped side face should abut the flange of the mounting dolly.

Note

When using grease, the bearing should be lubricated before mounting. Special care should be taken to prevent the sleeve from skewing or tilting when it is being pressed into the housing. Otherwise the rollers and raceways could easily be damaged.

Mounting dolly

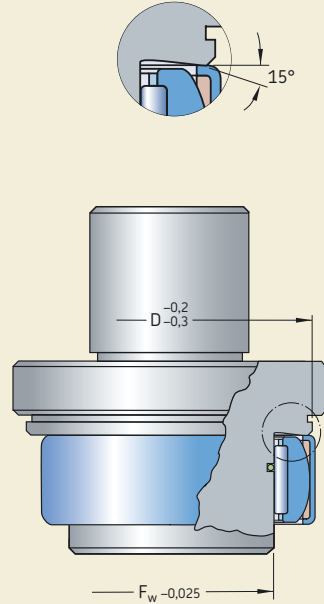
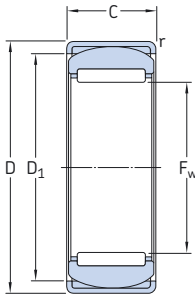

Fig. 5

Alignment needle roller bearings without an inner ring

F_w 15 – 45 mm



RPNA

Principal dimensions			Basic load ratings		Fatigue load limit	Speed ratings		Mass	Designation
F_w	D	C	dynamic	static		Reference speed	Limiting speed		
mm			kN		kN	r/min		kg	–
15	28	12	7,37	9,15	1,08	24 000	28 000	0,032	RPNA 15/28
18	32	16	12,8	17,6	2,12	22 000	24 000	0,052	RPNA 18/32
20	35	16	13,2	19,3	2,28	19 000	22 000	0,062	RPNA 20/35
25	42	20	19	32,5	4	16 000	18 000	0,11	RPNA 25/42
28	44	20	22	36,5	4,55	14 000	16 000	0,11	RPNA 28/44
30	47	20	22,9	38	4,8	13 000	15 000	0,13	RPNA 30/47
35	52	20	24,6	45	5,6	11 000	13 000	0,13	RPNA 35/52
40	55	20	26,4	51	6,3	10 000	11 000	0,14	RPNA 40/55
45	62	20	27,5	57	7,1	9 000	10 000	0,18	RPNA 45/62

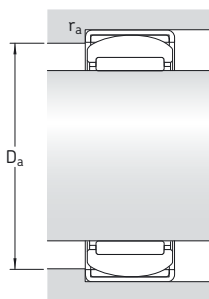

Dimensions			Abutment and fillet dimensions		
F_w	D_1	r_{\min}	D_a_{\min}	D_a_{\max}	r_a_{\max}
mm			mm		
15	24,5	1	23,5	24,5	1
18	27	1	26	27	1
20	30,5	1	29,5	30,5	1
25	36,5	1	35	37	1
28	38,5	1	37,5	39	1
30	42	1	41	42	1
35	47,5	1	46,5	47,5	1
40	50,5	1	49,5	50,5	1
45	58	1	57	58	1

Alignment needle roller bearings with an inner ring
d 12 – 40 mm

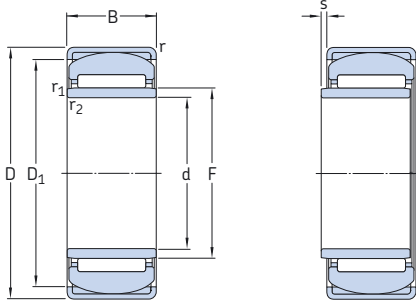

PNA

PNA

Principal dimensions			Basic load ratings		Fatigue load limit	Speed ratings		Mass	Designation
d	D	B	dynamic	static		Reference speed	Limiting speed		
mm			C	C ₀	P _u	r/min		kg	–
12	28	12	7,37	9,15	1,08	24 000	28 000	0,037	PNA 12/28
15	32	16	12,8	17,6	2,12	22 000	24 000	0,062	PNA 15/32
17	35	16	13,2	19,3	2,28	19 000	22 000	0,073	PNA 17/35
20	42	20	19	32,5	4	16 000	18 000	0,14	PNA 20/42
22	44	20	22	36,5	4,55	14 000	16 000	0,15	PNA 22/44
25	47	20	22,9	38	4,8	13 000	15 000	0,16	PNA 25/47
30	52	20	24,6	45	5,6	11 000	13 000	0,18	PNA 30/52
35	55	20	26,4	51	6,3	10 000	11 000	0,18	PNA 35/55
40	62	20	27,5	57	7,1	9 000	10 000	0,23	PNA 40/62

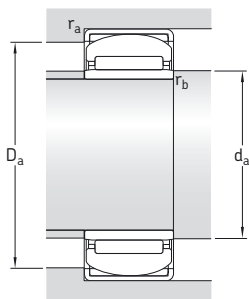

Dimensions

Abutment and fillet dimensions

d	F	D ₁	r _{min}	r _{1,2 min}	s ¹⁾	d _{a min}	D _{a min}	D _{a max}	r _{a max}	r _{b max}
mm						mm				
12	15	24,5	1	0,3	0,5	14	23,5	24,5	1	0,3
15	18	27	1	0,3	0,5	17	26	27	1	0,3
17	20	30,5	1	0,3	0,5	19	29,5	30,5	1	0,3
20	25	36,5	1	0,3	0,5	22	35	37	1	0,3
22	28	38,5	1	0,3	0,5	24	37,5	39	1	0,3
25	30	42	1	0,3	0,5	25	41	42	1	0,3
30	35	47,5	1	0,3	0,5	32	46,5	47,5	1	0,3
35	40	50,5	1	0,3	0,5	37	49,5	50,5	1	0,3
40	45	58	1	0,3	0,5	42	57	58	1	0,3

¹⁾ Permissible axial displacement from normal position of one bearing ring in relation to the other



Needle roller thrust bearings and bearing washers

Needle roller and cage thrust assemblies, AXK series.....	153
Needle roller thrust bearings with a centring spigot, AXW series	154
Bearing washers	154
Dimensions.....	157
Tolerances	157
Misalignment.....	157
Cages	158
Design of associated components	159
Raceways on a shaft and in a housing	160
Supplementary designations.....	160
Product tables	162
6.1 Needle roller and cage thrust assemblies and appropriate washers	162
6.2 Needle roller thrust bearings with a centring spigot and appropriate washers	166

Needle roller thrust bearings and bearing washers

SKF needle roller thrust bearings are fitted with a form-stable cage to reliably guide and retain a large number of needle rollers. The diameter deviations of the rollers within one assembly are within $2\ \mu\text{m}$, enabling these bearings to accommodate heavy axial loads and shock loads. These bearings provide a high degree of stiffness within a minimum axial space. In applications where the faces of adjacent machine components can serve as raceways, needle roller thrust bearings will take up no more space than a conventional thrust washer. They can accommodate axial loads acting in one direction only. SKF supplies needle roller thrust bearings in two designs:

- needle roller and cage thrust assemblies, AXK series (→ **fig. 1**)
- needle roller thrust bearings with a centring spigot, AXW series (→ **fig. 2**)

For applications where adjacent components cannot serve as raceways, the assemblies can also be combined with washers of various designs.

Fig. 1

Needle roller and cage thrust assembly

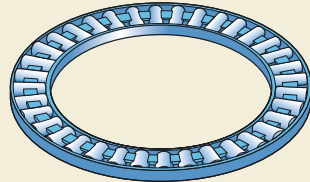

AXK series

Fig. 2

Needle roller thrust bearing with a centring spigot

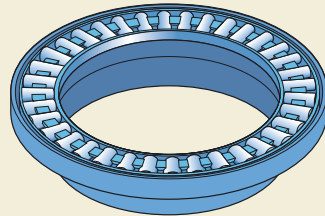

AXW series

Needle roller and cage thrust assemblies, AXK series

SKF needle roller and cage thrust assemblies in the AXK series (→ **fig. 1**) range from a 4 to 160 mm bore. If required, washers in the LS, AS, GS 811 or WS 811 series can be used with these assemblies.

Double direction bearings

A double direction needle roller thrust bearing can be created by combining two needle roller and cage thrust assemblies and bearing washers with an intermediate washer. Depending on the design of the intermediate washer, the bearing has internal centring (→ **fig. 3**) or external centring (→ **fig. 4**).

The intermediate washers must have the same surface finish and hardness as the bearing washers. For additional information, refer to the section *Design of associated components*, starting on **page 48**. SKF does not supply intermediate washers, but recommendations about suitable dimensions of the washers can be supplied on request.

Fig. 3

Double direction bearing arrangement with internal centring

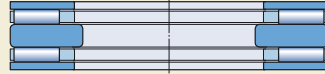
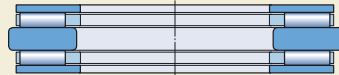

Fig. 4

Double direction bearing arrangement with external centring



Needle roller thrust bearings with a centring spigot, AXW series

SKF needle roller thrust bearings in the AXW series (→ **fig. 2, page 152**) consist of a needle roller and cage thrust assembly and a thrust washer with a centring spigot. The spigot facilitates the mounting process of the thrust bearing and provides an accurate radial centring of the housing washer. Available bore sizes for the thrust assembly range from 10 to 50 mm.

Combination with radial needle roller bearings

To accommodate combined radial and axial loads, AXW series needle roller thrust bearings can be combined with the following radial needle roller bearings:

- drawn cup needle roller bearings with a closed end or with open ends (→ **fig. 5**)
- needle roller bearings with machined rings (→ **fig. 6**)

These arrangements provide an economical and compact solution for combined loads.

Bearing washers

SKF bearing washers are required in cases where adjacent machine components cannot serve as raceways.

Available bore sizes for washers in the LS series range from 6 to 160 mm and in the AS series from 4 to 160 mm.

Washers in the LS and AS series can be used as a shaft washer (for AXK or AXW series needle roller thrust assemblies) or housing washer (for AXK series needle roller thrust assemblies).

Because of all the possible combinations, the appropriate washers must be ordered separately.

Raceway washers, LS series

Raceway washers in the LS series (→ **fig. 7**) are made of carbon chromium (rolling bearing) steel and are hardened. The raceway is ground and the bore and outside diameter are turned. These

Fig. 5

Needle roller thrust bearing, AXW series, combined with a drawn cup needle roller bearing

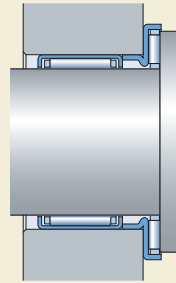

Fig. 6

Needle roller thrust bearings, AXW series, combined with a needle roller bearing with machined rings

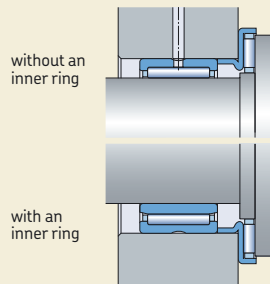
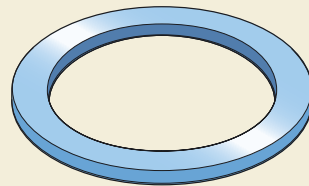

Fig. 7

Raceway washer



LS series

washers are used for bearing arrangements where accurate centring of the washers is not necessary or where low speeds are involved. The side face with the smaller chamfers is the raceway, and should face the rollers.

Thrust washers, AS series

Thrust washers in the AS series (→ **fig. 8**) are made of spring steel and are 1 mm thick. Both sides of these washers, which are hardened and polished, can be used as raceways. If adjacent machine components are not hardened but have adequate stiffness and the running accuracy requirements are moderate, washers in the AS series can be used to provide a cost-effective bearing arrangement.

Shaft and housing washers, WS 811 and GS 811 series

Shaft washers in the WS 811 series (→ **fig. 9**) and housing washers in the GS 811 series (→ **fig. 10**) are developed primarily for applications with cylindrical roller and cage thrust assemblies, but they can also be combined with needle roller and cage thrust assemblies. These washers, made of carbon chromium bearing steel are hardened and have precision machined raceways. Therefore, SKF recommends using these shaft and housing washers in high-speed applications where accurate centring of the bearing washers is required. WS 811 series shaft washers, which have a ground bore, are available in bore sizes ranging from 15 to 630 mm. When combined with needle roller and cage thrust assemblies, bore sizes up to 160 mm are used. GS 811 series housing washers, which have a ground outside diameter, are available for housing bore diameters ranging from 28 mm to 750 mm. When combined with needle roller and cage thrust assemblies, outside diameter sizes up to 200 mm are used.

Fig. 8

Thrust washer

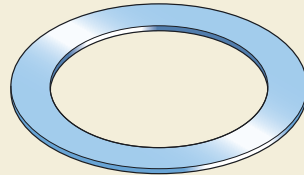

AS series

Fig. 9

Shaft washer

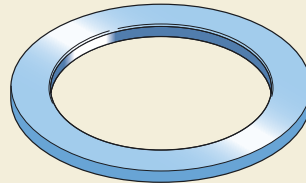

WS 811 series

Fig. 10

Housing washer

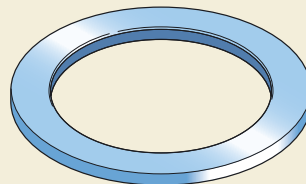

GS 811 series

Table 1

Tolerances for needle roller thrust bearings

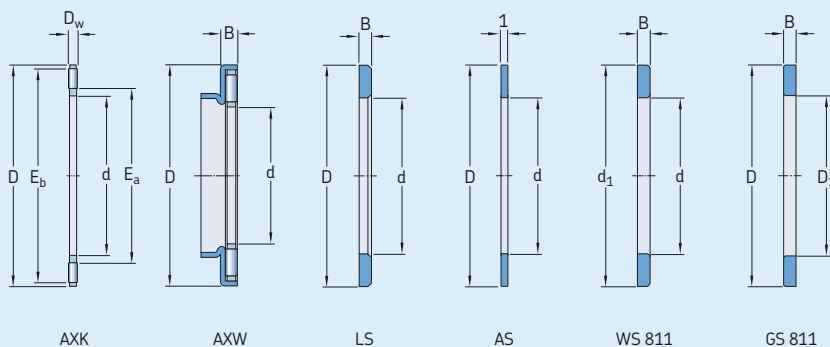

Bearing component
Dimensions

Tolerance, tolerance class

Needle roller and cage thrust assemblies, AXK

Bore diameter	d	E12
Outside diameter	D	c13
Roller diameter	D_w	Grade 2, ISO 3096:1996

Needle roller thrust bearings with a centring spigot, AXW

Bore diameter	d	E12
Outside diameter	D	-
Thickness	B	0/-0,2 mm
Roller diameter	D_w	Grade 2, ISO 3096:1996

Raceway washers, LS

Bore diameter	d	E12
Outside diameter	D	a12
Thickness	B	h11
Axial runout	s_i	Normal, ISO 199:2005

Thrust washers, AS

Bore diameter	d	E13
Outside diameter	D	e13
Thickness	B_1	$\pm 0,05$ mm

Shaft washers, WS 811

Bore diameter	d	Normal, ISO 199:2005
Outside diameter	d_1	-
Thickness	B	h11
Axial runout	s_i	Normal, ISO 199:2005

Housing washer, GS 811

Outside diameter	D	Normal, ISO 199:2005
Bore diameter	D_1	-
Thickness	B	h11
Axial runout	s_e	Normal, ISO 199:2005

Table 2

ISO tolerance classes

Nominal dimension over incl.		a12 Deviations high low		c13 Deviations high low		e13 Deviations high low		h11 Deviations high low		E12 Deviations high low		E13 Deviations high low	
mm		µm		µm		µm		µm		µm		µm	
3	6	-270	-390	-70	-250	-20	-200	0	-75	+140	+20	+200	+20
6	10	-280	-430	-80	-300	-25	-245	0	-90	+175	+25	+245	+25
10	18	-290	-470	-95	-365	-32	-302	0	-110	+212	+32	+302	+32
18	30	-300	-510	-110	-440	-40	-370	0	-130	+250	+40	+370	+40
30	40	-310	-560	-120	-510	-50	-440	0	-160	+300	+50	+440	+50
40	50	-320	-570	-130	-520	-50	-440	0	-160	+300	+50	+440	+50
50	65	-340	-640	-140	-600	-60	-520	0	-190	+360	+60	+520	+60
65	80	-360	-660	-150	-610	-60	-520	0	-190	+360	+60	+520	+60
80	100	-380	-730	-170	-710	-72	-612	0	-220	+422	+72	+612	+72
100	120	-410	-760	-180	-720	-72	-612	0	-220	+422	+72	+612	+72
120	140	-460	-860	-200	-830	-85	-715	0	-250	+485	+85	+715	+85
140	160	-520	-920	-210	-840	-85	-715	0	-250	+485	+85	+715	+85
160	180	-580	-980	-230	-860	-85	-715	0	-250	+485	+85	+715	+85
180	200	-660	-1 120	-240	-960	-100	-820	0	-290	+560	+100	+820	+100

Dimensions

The dimensions of needle roller and cage thrust assemblies and thrust washers in the AS series are in accordance with ISO 3031:2000.

The bore and outside diameters of the other bearing washers are in accordance with ISO 104:2002 for Diameter Series 1 thrust bearings.

Tolerances

Needle roller and cage thrust assemblies, needle roller thrust bearings with a spigot, and bearing washers are manufactured to the tolerance classes listed in **table 1**. The values for the dimension deviations of the various ISO tolerance classes mentioned in **table 1** are listed in **table 2**.

Misalignment

Needle roller thrust bearings cannot tolerate any angular misalignment between the shaft and the housing, or any misalignment between the shaft and the axial support surfaces in the housing.

The ends of the needle rollers are relieved slightly to modify the line contact between the raceways and the rollers. This provides favourable load distribution in the bearing and minimizes damaging edge stresses.

Cages

SKF needle roller and cage thrust assemblies are fitted as standard with a form-stable, machined steel cage (→ **fig. 11**) or a sheet steel cage (→ **fig. 12**), except for those identified by the designation suffix TN. These assemblies have an injection moulded, glass fibre reinforced, polyamide 66 cage (→ **fig. 13**).

The complete range of needle roller thrust bearings with a centring spigot in the AXW series are fitted exclusively with steel cages.

Note

Assemblies with a polyamide 66 cage can be used at temperatures up to +120 °C.

The lubricants generally used for rolling bearings do not have a detrimental effect on cage properties. Exceptions are a few synthetic oils and greases with a synthetic oil base and lubricants containing a high proportion of EP additives when used at high temperatures.

For bearing arrangements that will operate at continuously high temperatures or under arduous conditions, SKF recommends using needle roller and cage thrust assemblies with a steel cage.

For detailed information about the temperature resistance and the applicability of cages, refer to the section *Cage materials*, starting on **page 44**.

Fig. 11

Needle roller and cage thrust assembly with a machined steel cage



Fig. 12

Needle roller and cage thrust assembly with a sheet steel cage



Fig. 13

Needle roller and cage thrust assembly with a polyamide 66 cage



Table 3

Shaft and housing tolerance classes

Thrust bearing component	Series	Shaft tolerance class Internal guidance/ centring	Housing tolerance class External guidance/ centring
Needle roller and cage thrust assemblies	AXK	h8	–
Raceway washers	LS	h8 radial space	radial space H9
Thrust washers	AS	h8 radial space	radial space H9
Shaft washers	WS 811	h8	–
Housing washers	GS 811	–	H9

Design of associated components

The support surfaces in the housing and on the shaft must be at right angles to the shaft axis and should provide uninterrupted support for the bearing washers across the entire width of the raceways. When using thrust washers in the AS series, the dimensions E_a and E_b listed in the product tables should be applied.

To provide satisfactory radial guidance for the individual thrust bearing components, suitable tolerance classes for shafts and housings are listed in **table 3**. Radial space between the shaft and the bore is required for washers that are externally guided in the housing. For washers that are internally guided on the shaft, radial space in the housing bore is required.

When SKF needle roller and cage thrust assemblies in the AXW series are combined with drawn cup needle roller bearings or needle roller bearings, the same housing tolerance must be selected for the centring spigot as for the radial bearing.

Needle roller and cage thrust assemblies are generally guided radially on the shaft in order to obtain the lowest possible sliding speed against the guiding surfaces. At high speeds, radial guidance must be provided by the shaft and the guiding surface must be ground.

Raceways on a shaft and in a housing

For detailed information about suitable materials as well as surface hardness and surface finish, refer to the section *Raceways on shafts and in housings*, starting on **page 50**.

Raceways machined on the shaft or in the housing should have the same axial runout as is common for shaft or housing washers. The values for the permissible axial runout for the shaft and housing washers of thrust bearings are listed in **table 4**.

Supplementary designations

The designation suffixes used to identify certain features of SKF needle roller thrust bearings are explained in the following.

TN Injection moulded cage of glass fibre reinforced polyamide 66, rolling element centred

Table 4

Normal tolerances for thrust bearings

Shaft washer, WS 811

d	over	incl.	Δ_{dmp}		V_{dp}	$S_f^{1)}$	$\Delta_{Ts}^{1)}$	
			high	low			max	high
mm			μm		μm	μm	μm	
–	18		0	–8	6	10	+20	–250
18	30		0	–10	8	10	+20	–250
30	50		0	–12	9	10	+20	–250
50	80		0	–15	11	10	+20	–300
80	120		0	–20	15	15	+25	–300
120	180		0	–25	19	15	+25	–400

¹⁾ Also valid where raceway washers in the LS series are used

Housing washer, GS 811

D	over	incl.	Δ_{Dmp}		V_{Dp}	S_e
			high	low		
mm			μm		μm	μm
18	30		0	–13	10	10
30	50		0	–16	12	10
50	80		0	–19	14	10
80	120		0	–22	17	15
120	180		0	–25	19	15
180	250		0	–30	23	20

Needle roller and cage thrust assemblies and appropriate washers d 4 – 80 mm

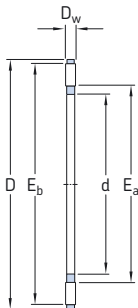

AXK

Dimensions					Basic load ratings		Fatigue load limit	Speed ratings		Mass	Designation
d	D	D _w	E _a	E _b	dynamic	static		Reference speed	Limiting speed		
mm					C	C ₀	P _u	r/min	g	–	
					kN		kN				
4	14	2	5	13	4,15	8,3	0,865	7 500	15 000	0,7	AXK 0414 TN
5	15	2	6	14	4,5	9,5	1	6 700	14 000	0,8	AXK 0515 TN
6	19	2	7	18	6,3	16	1,75	6 000	12 000	1	AXK 0619 TN
8	21	2	9	20	7,2	20	2,2	5 600	11 000	2	AXK 0821 TN
10	24	2	12	23	8,5	26	2,85	5 300	10 000	3	AXK 1024
12	26	2	14	25	9,15	30	3,25	5 000	10 000	3	AXK 1226
15	28	2	17	27	10,4	37,5	4,15	4 800	9 500	4	AXK 1528
17	30	2	19	29	11	40,5	4,5	4 500	9 500	4	AXK 1730
20	35	2	22	34	12	47,5	5,3	4 300	8 500	5	AXK 2035
25	42	2	29	41	13,4	60	6,7	3 800	7 500	7	AXK 2542
30	47	2	34	46	15	72	8	3 600	7 000	8	AXK 3047
35	52	2	39	51	16,6	83	9,3	3 200	6 300	10	AXK 3552
40	60	3	45	58	25	114	13,7	2 800	5 600	16	AXK 4060
45	65	3	50	63	27	127	15,3	2 600	5 300	18	AXK 4565
50	70	3	55	68	28,5	143	17	2 400	5 000	20	AXK 5070
55	78	3	60	76	34,5	186	22,4	2 200	4 300	28	AXK 5578
60	85	3	65	83	37,5	232	28,5	2 200	4 300	33	AXK 6085
65	90	3	70	88	39	255	31	2 000	4 000	35	AXK 6590
70	95	4	74	93	49	255	30,5	1 800	3 600	60	AXK 7095
75	100	4	79	98	50	265	32	1 700	3 400	61	AXK 75100
80	105	4	84	103	51	280	33,5	1 700	3 400	63	AXK 80105

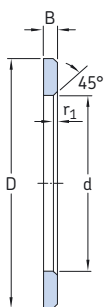

LS



AS

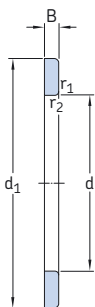

WS 811



GS 811

Dimensions
Washers

d

d₁

D

D₁

B

r_{1,2}
min
Masses
Washers
LS,
WS,
GS

AS

g

Designations
Raceway
washer
Thrust
washerShaft
washerHousing
washer

mm

d	d ₁	D	D ₁	B	r _{1,2} min	Masses Washers LS, WS, GS		Designations Raceway washer	Thrust washer	Shaft washer	Housing washer
mm						g		-			
4	-	14	-	-	-	-	1	-	AS 0414	-	-
5	-	15	-	-	-	-	1	-	AS 0515	-	-
6	-	19	-	2,75	0,3	6	2	LS 0619	AS 0619	-	-
8	-	21	-	2,75	0,3	6	2	LS 0821	AS 0821	-	-
10	-	24	-	2,75	0,3	8	3	LS 1024	AS 1024	-	-
12	-	26	-	2,75	0,3	9	3	LS 1226	AS 1226	-	-
15	28	28	16	2,75	0,3	9	3	LS 1528	AS 1528	WS 81102	GS 81102
17	30	30	18	2,75	0,3	10	4	LS 1730	AS 1730	WS 81103	GS 81103
20	35	35	21	2,75	0,3	14	5	LS 2035	AS 2035	WS 81104	GS 81104
25	42	42	26	3,00	0,6	21	7	LS 2542	AS 2542	WS 81105	GS 81105
30	47	47	32	3,00	0,6	24	8	LS 3047	AS 3047	WS 81106	GS 81106
35	52	52	37	3,50	0,6	32	9	LS 3552	AS 3552	WS 81107	GS 81107
40	60	60	42	3,50	0,6	43	12	LS 4060	AS 4060	WS 81108	GS 81108
45	65	65	47	4,00	0,6	54	13	LS 4565	AS 4565	WS 81109	GS 81109
50	70	70	52	4,00	0,6	59	14	LS 5070	AS 5070	WS 81110	GS 81110
55	78	78	57	5,00	0,6	94	18	LS 5578	AS 5578	WS 81111	GS 81111
60	85	85	62	4,75	1	110	22	LS 6085	AS 6085	WS 81112	GS 81112
65	90	90	67	5,25	1	120	24	LS 6590	AS 6590	WS 81113	GS 81113
70	95	95	72	5,25	1	130	25	LS 7095	AS 7095	WS 81114	GS 81114
75	100	100	77	5,75	1	150	27	LS 75100	AS 75100	WS 81115	GS 81115
80	105	105	82	5,75	1	160	28	LS 80105	AS 80105	WS 81116	GS 81116

Needle roller and cage thrust assemblies and appropriate washers
d 85 – 160 mm

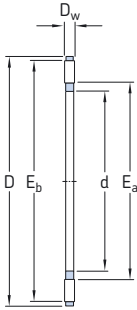

AXK

Dimensions					Basic load ratings		Fatigue load limit	Speed ratings		Mass	Designation
d	D	D _w	E _a	E _b	dynamic	static		Reference speed	Limiting speed		
mm					C	C ₀	P _u	r/min		g	–
85	110	4	89	108	52	290	34,5	1 700	3 400	67	AXK 85110
90	120	4	94	118	65,5	405	48	1 500	3 000	86	AXK 90120
100	135	4	105	133	76,5	560	65,5	1 400	2 800	100	AXK 100135
110	145	4	115	143	81,5	620	71	1 400	2 800	120	AXK 110145
120	155	4	125	153	86,5	680	76,5	1 300	2 600	130	AXK 120155
130	170	5	136	167	112	830	93	1 100	2 200	210	AXK 130170
140	180	5	146	177	116	900	98,6	1 000	2 000	220	AXK 140180
150	190	5	156	187	120	950	102	1 000	2 000	230	AXK 150190
160	200	5	166	197	125	1000	106	950	1 900	250	AXK 160200

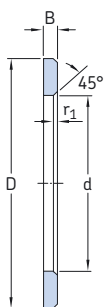

LS



AS

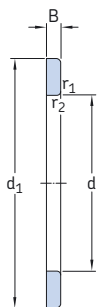

WS 811



GS 811

Dimensions
Washers

d
mm

d₁

D

D₁

B

r_{1,2}
min

Masses
Washers
LS,
WS,
GS

AS

g

Designations
Raceway
washer

Thrust
washer

Shaft
washer

Housing
washer

-

Dimensions	d	d ₁	D	D ₁	B	r _{1,2} min	Masses Washers LS, WS, GS	AS	Designations Raceway washer	Thrust washer	Shaft washer	Housing washer
	mm						g		-			
85	110	110	87	5,75	1	170	29	LS 85110	AS 85110	WS 81117	GS 81117	
90	120	120	92	6,50	1	250	39	LS 90120	AS 90120	WS 81118	GS 81118	
100	135	135	102	7,00	1	350	50	LS 100135	AS 100135	WS 81120	GS 81120	
110	145	145	112	7,00	1	380	55	LS 110145	AS 110145	WS 81122	GS 81122	
120	155	155	122	7,00	1	410	59	LS 120155	AS 120155	WS 81124	GS 81124	
130	170	170	132	9,00	1	660	65	LS 130170	AS 130170	WS 81126	GS 81126	
140	178	180	142	9,50	1	700	79	LS 140180	AS 140180	WS 81128	GS 81128	
150	188	190	152	9,50	1	750	84	LS 150190	AS 150190	WS 81130	GS 81130	
160	198	200	162	9,50	1	790	89	LS 160200	AS 160200	WS 81132	GS 81132	

Needle roller thrust bearings with a centring spigot and appropriate washers
 d 10 – 50 mm

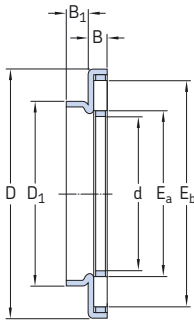

AXW

Dimensions								Basic load ratings		Fatigue load limit P_u	Speed ratings		Mass	Designation
d	D	D ₁	B	B ₁	E _a	E _b	dynamic	static	Reference speed		Limiting speed			
mm								kN		kN	r/min		g	-
10	27	14	3,2	3	12	23	8,5	26	2,85	5 300	10 000	8,3	AXW 10	
12	29	16	3,2	3	14	25	9,15	30	3,25	5 000	10 000	9,1	AXW 12	
15	31	21	3,2	3,5	17	27	10,4	37,5	4,15	4 800	9 500	10	AXW 15	
17	33	23	3,2	3,5	19	29	11	40,5	4,5	4 500	9 500	11	AXW 17	
20	38	26	3,2	3,5	22	34	12	47,5	5,3	4 300	8 500	14	AXW 20	
25	45	32	3,2	4	29	41	13,4	60	6,7	3 800	7 500	20	AXW 25	
30	50	37	3,2	4	34	46	15	72	8	3 600	7 000	22	AXW 30	
35	55	42	3,2	4	39	51	16,6	83	9,3	3 200	6 300	27	AXW 35	
40	63	47	4,2	4	45	58	25	114	13,7	2 800	5 600	39	AXW 40	
45	68	52	4,2	4	50	63	27	127	15,3	2 600	5 300	43	AXW 45	
50	73	58	4,2	4,5	55	68	28,5	143	17	2 400	5 000	49	AXW 50	

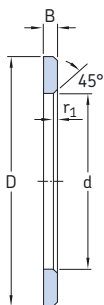

LS



AS

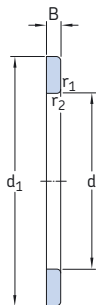

WS 811

Dimensions
Washers

Masses
Washers
LS, WS AS

Designations
Raceway washer

Thrust washer

Shaft washer

d d₁, D B r_{1,2}
min

mm

g

-

10	24	2,75	0,3	8	3	LS 1024	AS 1024	-
12	26	2,75	0,3	9	3	LS 1226	AS 1226	-
15	28	2,75	0,3	9	3	LS 1528	AS 1528	WS 81102
17	30	2,75	0,3	10	4	LS 1730	AS 1730	WS 81103
20	35	2,75	0,3	14	5	LS 2035	AS 2035	WS 81104
25	42	3,00	0,6	21	7	LS 2542	AS 2542	WS 81105
30	47	3,00	0,6	24	8	LS 3047	AS 3047	WS 81106
35	52	3,50	0,6	32	9	LS 3552	AS 3552	WS 81107
40	60	3,50	0,6	43	12	LS 4060	AS 4060	WS 81108
45	65	4,00	0,6	54	13	LS 4565	AS 4565	WS 81109
50	70	4,00	0,6	59	14	LS 5070	AS 5070	WS 81110



Combined needle roller bearings

Needle roller / angular contact ball bearings	170
Needle roller / angular contact ball bearings, NKIA series	170
Needle roller / angular contact ball bearings, NKIB series.....	170
Dimensions.....	171
Tolerances.....	171
Internal clearance.....	171
Misalignment.....	171
Cages.....	172
Shaft and housing tolerances	172
Lubrication.....	173
Product tables.....	174
7.1 Needle roller / angular contact ball bearings	174
Needle roller / thrust ball bearings	178
Needle roller / thrust ball bearings, NX series	179
Needle roller / thrust ball bearings, NKX series	180
Dimensions.....	180
Tolerances.....	180
Shaft and housing tolerances	180
Internal clearance.....	181
Misalignment.....	181
Cages.....	182
Lubrication.....	182
Design of associated components	183
Application recommendations	183
Supplementary designations.....	183
Product tables.....	184
7.2 Needle roller / thrust ball bearings, full complement thrust bearing.....	184
7.3 Needle roller / thrust ball bearings, thrust bearing with a cage	186
Needle roller / cylindrical roller thrust bearings	188
Needle roller / cylindrical roller thrust bearings, NKXR series	188
Needle roller / cylindrical roller thrust bearings, NKXR .. Z series.....	188
Dimensions.....	189
Tolerances.....	189
Shaft and housing tolerances	189
Internal clearance.....	189
Misalignment.....	190
Cages.....	190
Lubrication.....	190
Design of associated components	191
Application recommendations	191
Supplementary designations.....	191
Product tables.....	192
7.4 Needle roller / cylindrical roller thrust bearings.....	192

Needle roller / angular contact ball bearings

Combined needle roller bearings consist of a radial needle roller bearing combined with a thrust bearing and are consequently able to accommodate both radial and axial loads. Combined needle roller bearings provide the means to produce locating bearing arrangements where radial space is limited. They are particularly suitable for applications where other types of locating bearings occupy too much space, or where the axial loads are too heavy, the speeds are too high, or the lubricant is inadequate for simple thrust washers. SKF supplies combined needle roller bearings in the following designs:

- needle roller / angular contact ball bearings
- needle roller / thrust ball bearings
- needle roller / cylindrical roller thrust bearings

Needle roller / angular contact ball bearings

Needle roller / angular contact ball bearings combine a radial needle roller bearing with a radial angular contact ball bearing to produce a low cross section bearing that can operate at high speeds and accommodate heavy radial and light axial loads. The radial loads are accommodated exclusively by the needle roller bearing. SKF supplies these bearings in the following two series:

- NKIA series (→ **fig. 1**), accommodates axial loads in one direction
- NKIB series (→ **fig. 2**), accommodates axial loads in both directions

Note

Bearings of both series are separable. In other words, the inner ring can be mounted separately from the outer ring, roller and cage assemblies. However, the bearings must be kept together as supplied – e.g. the outer ring, roller and cage assembly from one bearing are not interchangeable with the the roller and cage assembly from another seemingly identical bearing.

Needle roller / angular contact ball bearings, NKIA series

SKF needle roller / angular contact ball bearings in the NKIA 59 series (→ **fig. 1**) can accommodate axial loads acting in one direction and can therefore locate the shaft in one direction.

For short shafts, where changes in length as a result of thermal expansion are relatively minor, two bearings in the NKIA 59 series can be used in a back-to-back (mirrored) arrangement (→ **fig. 3**).

Needle roller / angular contact ball bearings, NKIB series

Needle roller / angular contact ball bearings in the NKIB 59 series (→ **fig. 2**) are able to locate

Fig. 1

Needle roller / angular contact ball bearing

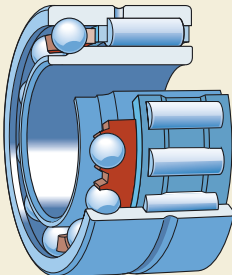

NKIA 59 series

Fig. 2

Needle roller / angular contact ball bearing

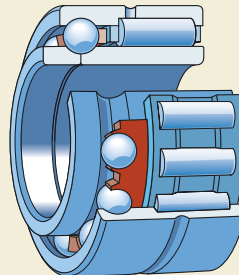

NKIB 59 series

a shaft in both directions with an axial play between 0,08 and 0,25 mm. To facilitate mounting, the bearing has a two-piece inner ring. When mounting the inner ring, it is important that the two pieces are mounted immediately adjacent to each other without any gap between them.

Dimensions

The boundary dimensions of bearings in the NKIA 59 series are in accordance with Dimension Series 59 of ISO 15:1998.

With the exception of the inner ring width, which is extended on one side, the boundary dimensions of bearings in the NKIB 59 series are in accordance with Dimension Series 59 of ISO 15:1998.

Tolerances

SKF supplies needle roller / angular contact ball bearings to Normal tolerances in accordance with ISO 492:2002 as standard.

The following tolerances in the NKIB 59 series are exceptions:

- The bore diameter of the narrow part of the inner ring is slightly larger.
- The width tolerances of the complete inner ring is 0/-0,3 mm for all sizes.

Internal clearance

SKF supplies needle roller / angular contact ball bearings with Normal radial internal clearance as standard.

The values for radial internal clearance are listed in **table 7** on **page 42** and are in accordance with ISO 5753:1991. They are valid for unmounted bearings under zero measuring load.

Misalignment

SKF needle rollers are relieved slightly toward their ends. The modified line contact achieved between the raceways and the needle rollers provides favourable load distribution in the bearing and minimizes damaging edge stresses. It also enables needle roller / angular contact ball bearings to accommodate a minimum amount of misalignment. The detrimental effect of misalignment increases with increasing bearing width and load. Needle roller / angular contact ball bearings are sensitive to misalignment. If misalignment can not be avoided, contact the SKF application engineering service.

Fig. 3

NKIA 59 series, back-to-back arrangement

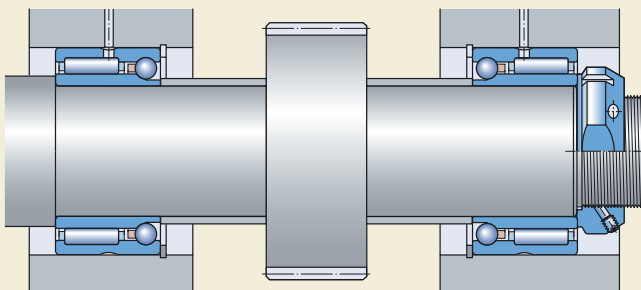

Needle roller / angular contact ball bearings

Cages

The radial needle roller bearing is fitted as standard with a machined steel cage (→ **fig. 4**) or a sheet steel cage (→ **fig. 5**). The balls of the angular contact ball bearing are retained in an injection moulded cage made of glass fibre reinforced polyamide 66 (→ **fig. 6**).

Note

Limited by the polyamide 66 cage, needle roller / angular contact ball bearings should not be operated at temperatures above 120 °C.

The lubricants generally used for rolling bearings do not have a detrimental effect on cage properties. Exceptions are a few synthetic oils and greases with a synthetic oil base and lubricants containing a high proportion of EP additives when used at high temperatures.

For detailed information about the temperature resistance and the applicability of cages, refer to the section *Cage materials*, starting on **page 44**.

Shaft and housing tolerances

For needle roller / angular contact ball bearings SKF recommends machining the shaft seat to a k5 tolerance class, and the housing bore seat to an M6 tolerance class.

Tighter fits than those achieved with these tolerance classes should be avoided as they could have a negative influence on bearing performance.

In addition to their interference fit on the shaft and in the housing, the bearing rings should be located axially by a shaft shoulder or snap ring.

Fig. 4

Machined steel cage of the radial bearing



Fig. 5

Sheet steel cage of the radial bearing

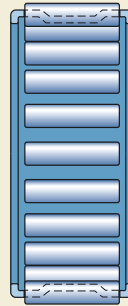

Fig. 6

Polyamide 66 cage of the angular contact ball bearing



Lubrication

To facilitate efficient lubrication, the needle roller bearing has an annular groove with one lubrication hole in the outer ring. Depending on the application, needle roller / angular contact ball bearings can be grease or oil lubricated. In the case of grease lubrication, both the needle roller bearing and ball bearing should be filled with the same lubricant. If grease lubrication is going to be used, the bearing should be lubricated before mounting.

Relubrication intervals for the needle roller and angular contact ball bearing must be calculated separately. The lower of the two intervals should be used.

For additional information about lubrication, refer to the section *Lubrication*, starting on **page 52**.

Needle roller / angular contact ball bearings

d 12 – 60 mm

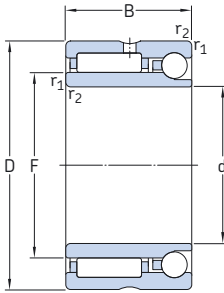

NKIA

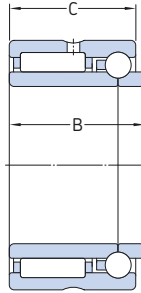

NKIB

Principal dimensions	Basic load ratings				Fatigue load limits				Speed ratings		Mass	Designation			
	d	D	B	C	radial dynamic C	static C ₀	axial dynamic C	static C ₀	radial P _u	axial P _u			Reference speed	Limiting speed	kg
mm															
				kN				kN				r/min		kg	
12	24	16	–	8,25	10	2,07	1,92	1,14	0,083	22 000	26 000	0,04	NKIA 5901		
	24	17,5	16	8,25	10	2,07	1,92	1,14	0,083	22 000	26 000	0,043	NKIB 5901		
15	28	18	–	11,4	15,6	2,27	2,37	1,83	0,099	19 000	22 000	0,05	NKIA 5902		
	28	20	18	11,4	15,6	2,27	2,37	1,83	0,099	19 000	22 000	0,052	NKIB 5902		
17	30	18	–	11,7	17	2,24	2,74	1,96	0,116	18 000	20 000	0,056	NKIA 5903		
	30	20	18	11,7	17	2,24	2,74	1,96	0,116	18 000	20 000	0,058	NKIB 5903		
20	37	23	–	21,6	28	3,79	4,21	3,35	0,176	15 000	17 000	0,1	NKIA 5904		
	37	25	23	21,6	28	3,79	4,21	3,35	0,176	15 000	17 000	0,11	NKIB 5904		
22	39	23	–	23,3	32	4,14	4,93	3,9	0,205	14 000	15 000	0,12	NKIA 59/22		
	39	25	23	23,3	32	4,14	4,93	3,9	0,205	14 000	15 000	0,12	NKIB 59/22		
25	42	23	–	24,2	34,5	4,24	5,26	4,15	0,224	13 000	15 000	0,13	NKIA 5905		
	42	25	23	24,2	34,5	4,24	5,26	4,15	0,224	13 000	15 000	0,13	NKIB 5905		
30	47	23	–	25,5	39	4,54	6,32	4,65	0,268	11 000	13 000	0,15	NKIA 5906		
	47	25	23	25,5	39	4,54	6,32	4,65	0,268	11 000	13 000	0,15	NKIB 5906		
35	55	27	–	31,9	54	5,83	8,42	6,7	0,355	9 500	11 000	0,24	NKIA 5907		
	55	30	27	31,9	54	5,83	8,42	6,7	0,355	9 500	11 000	0,25	NKIB 5907		
40	62	30	–	42,9	71	7,17	10,9	8,8	0,467	8 000	9 500	0,32	NKIA 5908		
	62	34	30	42,9	71	7,17	10,9	8,8	0,467	8 000	9 500	0,32	NKIB 5908		
45	68	30	–	45,7	78	7,47	12	9,65	0,513	7 500	8 500	0,38	NKIA 5909		
	68	34	30	45,7	78	7,47	12	9,65	0,513	7 500	8 500	0,38	NKIB 5909		
50	72	30	–	47,3	85	7,74	13,7	10,6	0,579	7 000	8 000	0,38	NKIA 5910		
	72	34	30	47,3	85	7,74	13,7	10,6	0,579	7 000	8 000	0,39	NKIB 5910		
55	80	34	–	57,2	104	9,27	16,7	13,2	0,697	6 300	7 000	0,55	NKIA 5911		
	80	38	34	57,2	104	9,27	16,7	13,2	0,697	6 300	7 000	0,56	NKIB 5911		
60	85	34	–	59,4	114	9,58	18	14,3	0,77	6 000	6 700	0,59	NKIA 5912		
	85	38	34	59,4	114	9,58	18	14,3	0,77	6 000	6 700	0,6	NKIB 5912		

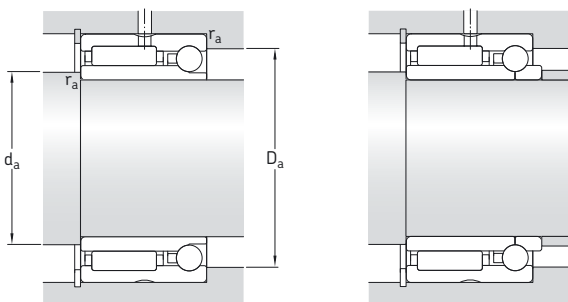

Dimensions

Abutment and fillet dimensions

d	F	r _{1,2} min	d _a min	D _a max	r _a max
mm		mm			
12	16	0,3	14	22	0,3
	16	0,3	14	22	0,3
15	20	0,3	17	26	0,3
	20	0,3	17	26	0,3
17	22	0,3	19	28	0,3
	22	0,3	19	28	0,3
20	25	0,3	22	35	0,3
	25	0,3	22	35	0,3
22	28	0,3	24	37	0,3
	28	0,3	24	37	0,3
25	30	0,3	27	40	0,3
	30	0,3	27	40	0,3
30	35	0,3	32	45	0,3
	35	0,3	32	45	0,3
35	42	0,6	39	51	0,6
	42	0,6	39	51	0,6
40	48	0,6	44	58	0,6
	48	0,6	44	58	0,6
45	52	0,6	49	64	0,6
	52	0,6	49	64	0,6
50	58	0,6	54	68	0,6
	58	0,6	54	68	0,6
55	63	1	60	75	1
	63	1	60	75	1
60	68	1	65	80	1
	68	1	65	80	1

Needle roller / angular contact ball bearings
d 65 – 70 mm

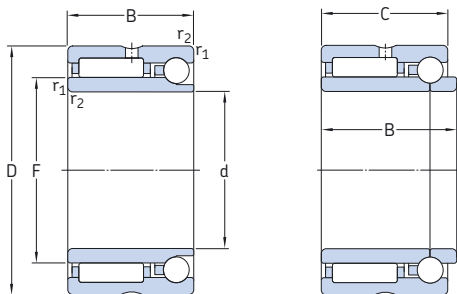

NKIA

NKIB

Principal dimensions				Basic load ratings				Fatigue load limits		Speed ratings		Mass	Designation
d	D	B	C	radial dynamic C	static C ₀	axial dynamic C	static C ₀	radial P _u	axial P _u	Reference speed	Limiting speed	kg	
mm				kN				kN		r/min		kg	-
65	90	34	-	60,5	118	9,96	19,2	14,6	0,816	5 600	6 300	0,64	NKIA 5913
	90	38	34	60,5	118	9,96	19,2	14,6	0,816	5 600	6 300	0,64	NKIB 5913
70	100	40	-	84,2	163	13,2	25	20,8	1,05	5 000	5 600	0,98	NKIA 5914
	100	45	40	84,2	163	13,2	25	20,8	1,05	5 000	5 600	0,99	NKIB 5914

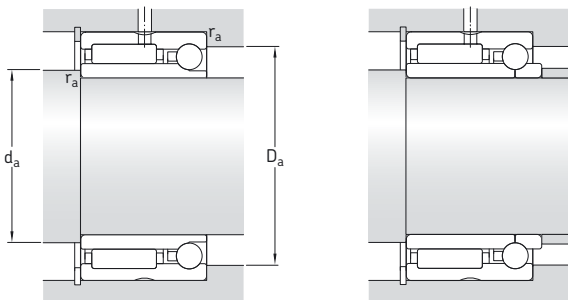

Dimensions

Abutment and fillet dimensions

d	F	$r_{1,2}$ min	d_a min	D_a max	r_a max
mm			mm		
65	72	1	70	85	1
	72	1	70	85	1
70	80	1	75	95	1
	80	1	75	95	1

Needle roller / thrust ball bearings

Needle roller / thrust ball bearings combine a radial needle roller bearing and a thrust ball bearing. SKF supplies these bearings in the following two series:

- NX series (→ **fig. 7**), a needle roller bearing with a full complement thrust ball bearing
- NKX series (→ **fig. 8**), a needle roller bearing with a thrust ball bearing with a cage

SKF supplies the bearings in both series without an inner ring. However, for applications where it is not possible to harden and grind the shaft, the needle roller bearing can be combined with an inner ring (→ **fig. 9**). Appropriate inner rings are listed in the product tables and can be ordered separately.

Fig. 7

Needle roller / thrust ball bearing

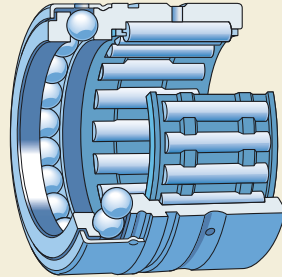

NX series

Fig. 8

Needle roller / thrust ball bearing

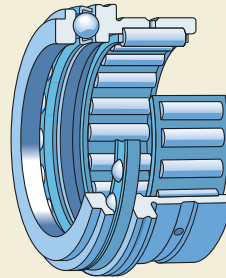

NKX series

Fig. 9

Needle roller / thrust ball bearing, combined with an inner ring

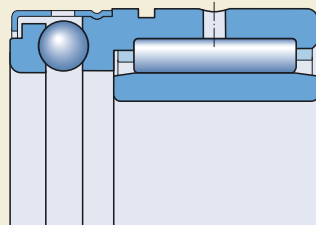

NX series

Needle roller / thrust ball bearings, NX series

SKF needle roller / full complement thrust ball bearings in the NX series are suitable for applications where there are moderate radial loads and lighter, single direction axial loads. Their extremely low sectional height enables shaft centrelines to be positioned close together as is the case for multi-spindle drilling machines.

For axial support, the bearings may be mounted against a shoulder or snap ring in the housing bore. The snap ring groove in the outer ring provides a cost-effective and axially space-saving arrangement (→ **fig. 10**). The appropriate snap rings are listed in the product tables.

Needle roller / thrust ball bearings in the NX series have a stamped steel cover that extends over the shaft washer of the thrust ball bearing and is firmly attached to the radial needle roller bearing. These bearings are therefore non-separable. Bearings in the NX series have lubrication holes in the cover (→ **fig. 11**) and are intended for oil lubrication.

Bearings in the NX .. Z series (→ **fig. 12**) should be grease lubricated. SKF supplies the thrust ball bearing in this series filled, as standard, with a high-quality grease with good rust-inhibiting properties. The cover, which has no lubrication holes, forms a gap-type seal with the shaft washer to retain the grease in the bearing.

Fig. 10

NX series mounted with a snap ring

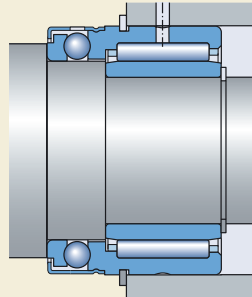
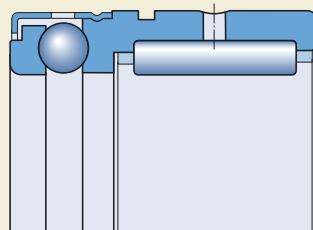

Fig. 11

Needle roller / thrust ball bearing, with lubrication holes in the cover



NX series

Fig. 12

Needle roller / thrust ball bearing, no lubrication holes in the cover

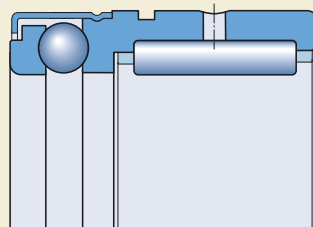

NX .. Z series

Needle roller / thrust ball bearings

Needle roller / thrust ball bearings, NKX series

SKF needle roller / thrust ball bearings in the NKX series combine a radial needle roller bearing and a thrust ball bearing based on the 511 series. They are able to support single-direction axial loads in addition to radial loads. They also permit relatively high-speed operation.

NKX series needle roller / thrust ball bearings (→ **fig. 13**) do not have a cover around the thrust ball bearing. As a result, both the ball and cage assembly and shaft washer can be mounted separately from the rest of the bearing.

NKX .. Z series needle roller / thrust ball bearings (→ **fig. 14**) are non-separable. They have a stamped steel cover that extends over the shaft washer of the thrust ball bearing. It is firmly attached to the housing washer that is integral to the needle roller bearing outer ring. The cover makes these bearings non-separable. SKF supplies the thrust ball bearing in this series filled, as standard, with a high-quality grease that has good rust inhibiting properties. The cover, which has no lubrication holes, forms a gap-type seal with the shaft washer to retain the grease in the bearing.

Dimensions

The boundary dimensions of needle roller / thrust ball bearings in the NKX and NKX .. Z series are in accordance with DIN 5429-1:2005-08.

The dimensions of bearings in the NX and NX .. Z series are not standardized, but are common in the market.

Tolerances

SKF needle roller / thrust ball bearings are manufactured to the tolerances and tolerance classes listed in **table 1**. The radial runout values are in accordance with ISO 492:2002 and the Normal axial runout values are in accordance with ISO 199:2005.

The values for the deviations from the nominal diameter of the ISO tolerance classes F6 and E8 in **table 1** are listed in **table 2**.

Shaft and housing tolerances

SKF recommends machining the shaft seat to a k5 tolerance class for bearings with or without an inner ring.

For the housing bore seat, SKF recommends a K6 tolerance class. For stiff bearing arrangements, SKF recommends an M6 housing bore tolerance class.

In addition to their interference fit on the shaft and in the housing, the bearing rings must be axially located by a shoulder or snap ring.

Fig. 13

Needle roller / thrust ball bearing

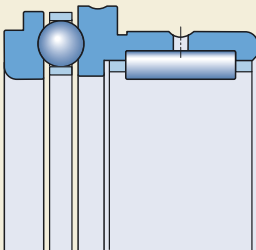

NKX series

Fig. 14

Needle roller / thrust ball bearing

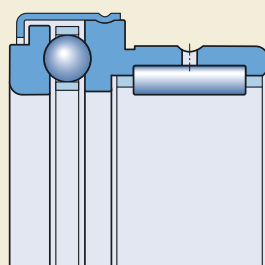

NKX .. Z series

Internal clearance

SKF needle roller / thrust ball bearings combined with the appropriate inner ring, as listed in the product tables, have Normal radial internal clearance as standard. The clearance values are listed in **table 7** on **page 42** and are in accordance with ISO 5753:1991. They are valid for unmounted bearings under zero measuring load.

The radial internal clearance for SKF needle roller / thrust ball bearings without an inner ring depends on the shaft tolerance. If the recommended k5 shaft tolerance class is applied, the tolerance for the inside diameter F_w will provide an internal clearance that is slightly less than the Normal radial internal clearance.

Misalignment

SKF needle roller / thrust ball bearings in the NX and NKX series cannot tolerate any angular misalignment between the shaft and the housing or any misalignment between the shaft and the axial support surfaces in the housing.

Table 1

Needle roller / thrust ball bearing tolerances

Dimension ¹⁾		Tolerance, tolerance class
Outside diameter	D	Normal, ISO 492:1994
Inside diameter of needle roller complement	F_w	F6
Bore diameter	d	E8
Width	C	0/-0,25 mm
Width ²⁾	C_1	0/-0,20 mm

¹⁾ Refer to the illustrations in the product tables, starting on **page 184**.

²⁾ Applicable to bearings in the NKX and NKX .. Z series only

Table 2

ISO tolerance classes

Nominal diameter over incl.	E8 Deviations		F6 Deviations	
	high	low	high	low
mm	µm		µm	
6 10	+47	+25	+22	+13
10 18	+59	+32	+27	+16
18 30	+73	+40	+33	+20
30 50	+89	+50	+41	+25
50 80	+106	+60	+49	+30

Needle roller / thrust ball bearings

Cages

The radial needle roller bearing is fitted as standard with a machined steel (→ **fig. 4**, **page 172**) or a sheet steel cage (→ **fig. 5**, **page 172**), no designation suffix. However, some small bearings are fitted as standard with an injection moulded cage of glass fibre reinforced polyamide 66 (→ **fig. 15**), designation suffix TN.

The cage, that retains the balls of the thrust ball bearing (NKX series), is made of sheet steel (→ **fig. 16**).

Note

Needle roller / thrust ball bearings with a polyamide 66 cage should not be operated at temperatures above 120 °C.

The lubricants generally used for rolling bearings do not have a detrimental effect on cage properties. Exceptions are a few synthetic oils and greases with a synthetic oil base and lubricants containing a high proportion of EP additives when used at high temperatures.

For bearing arrangements that will operate at continuously high temperatures or under arduous conditions, SKF recommends using needle roller / thrust ball bearings with steel cages.

For detailed information about the temperature resistance and the applicability of cages, refer to the section *Cage materials*, starting on **page 44**.

Lubrication

To facilitate efficient lubrication, the needle roller bearing has an annular groove with one lubrication hole in the outer ring.

The shielded thrust bearing of needle roller / thrust ball bearings with the designation suffix Z is filled at the factory with a high-quality grease that has good corrosion inhibiting properties. For relubrication, SKF recommends SKF LGWA 2 grease. For additional information about greases, refer to the section *Lubrication*, starting on **page 52**.

Bearings in the NKX and NX series without the designation suffix Z should be oil lubricated whenever possible, as oil facilitates an adequate supply of lubricant to the bearing.

Fig. 15

Polyamide 66 cage of the radial bearing

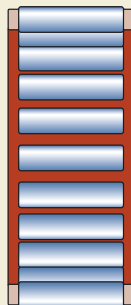

Fig. 16

Sheet steel cage of the thrust ball bearing, NKX series



Relubrication intervals for the axial and radial components must be calculated separately. The lower of the two intervals should be used. A calculation is needed for both oil and grease lubrication.

Design of associated components

The diameter of the support surface for the integral housing washer of a needle roller / thrust ball bearing must always be at least 0,5 mm larger than the dimension D_1 or D_2 (→ fig. 17) to obtain a clearance fit. The values for the diameters D_1 and D_2 are listed in the product table.

Application recommendations

SKF needle roller / thrust ball bearings can locate a shaft axially in one direction only. For short shafts, where changes in length as a result of thermal expansion are relatively minor, two bearings can be used in a back-to-back (mirrored) arrangement (→ fig. 18). In these cases SKF recommends elastically preloading the thrust ball bearings with cup springs (belleville washers). This elastic preload helps to avoid skidding of the balls when one of the thrust bearings is unloaded and facilitates proper and quiet performance of the thrust ball bearing.

Supplementary designations

The designation suffixes used to identify certain features of SKF needle roller / thrust ball bearings are explained in the following.

- Z Thrust ball bearing with a cover over the outside diameter without lubrication holes. Filled at the factory with a high-quality lithium base NLGI 2 grease.

Fig. 17

Clearance fit for the integral housing washer

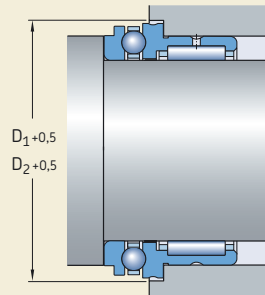
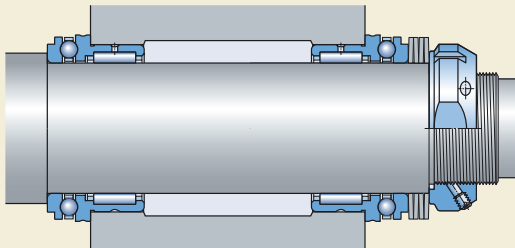

Fig. 18

NKX series, back-to-back arrangement, incorporating belleville washers



Needle roller / thrust ball bearings, full complement thrust bearing

F_w 7 – 35 mm

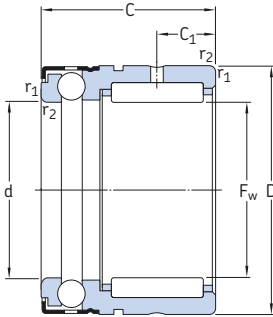

NX

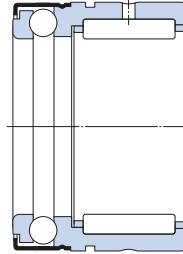

NX..Z

Principal dimensions	Basic load ratings						Fatigue load limits		Min. load factor A	Speed ratings		Mass	Designation
	F _w	D	C	radial C	dynamic C ₀	static C ₀	axial C	dynamic C ₀		radial P _u	axial P _u		
mm	kN						kN		–	r/min		kg	–
7	14	18	2,81	2,75	3,45	5	0,29	0,186	0,13	10 000	11 000	0,014	NX 7 TN ¹⁾
	14	18	2,81	2,75	3,45	5	0,29	0,186	0,13	10 000	6 000	0,014	NX 7 ZTN ¹⁾
10	19	18	4,68	4,15	5,07	8,5	0,475	0,31	0,38	8 500	9 500	0,025	NX 10
	19	18	4,68	4,15	5,07	8,5	0,475	0,31	0,38	8 500	5 600	0,025	NX 10 Z
12	21	18	5,5	5,4	5,27	9,65	0,61	0,355	0,48	8 000	9 000	0,028	NX 12
	21	18	5,5	5,4	5,27	9,65	0,61	0,355	0,48	8 000	5 300	0,028	NX 12 Z
15	24	28	11,2	14	6,18	12,2	1,66	0,45	0,77	7 500	8 500	0,048	NX 15
	24	28	11,2	14	6,18	12,2	1,66	0,45	0,77	7 500	5 300	0,048	NX 15 Z
17	26	28	12,3	16,6	6,37	13,4	1,96	0,5	0,93	7 000	8 500	0,053	NX 17
	26	28	12,3	16,6	6,37	13,4	1,96	0,5	0,93	7 000	5 000	0,053	NX 17 Z
20	30	28	13,4	19,6	7,8	17,3	2,28	0,64	1,6	6 300	7 500	0,068	NX 20
	30	28	13,4	19,6	7,8	17,3	2,28	0,64	1,6	6 300	4 500	0,068	NX 20 Z
25	37	30	15,4	25	12,4	28,5	2,9	1,06	4,2	5 600	6 300	0,12	NX 25
	37	30	15,4	25	12,4	28,5	2,9	1,06	4,2	5 600	3 800	0,12	NX 25 Z
30	42	30	22,9	39	12,7	32,5	4,8	1,2	5,5	5 300	6 000	0,13	NX 30
	42	30	22,9	39	12,7	32,5	4,8	1,2	5,5	5 300	3 600	0,13	NX 30 Z
35	47	30	24,6	45	13,5	38	5,6	1,4	7,5	5 000	5 600	0,16	NX 35
	47	30	24,6	45	13,5	38	5,6	1,4	7,5	5 000	3 400	0,16	NX 35 Z

¹⁾ Radial bearing with inserted closure ring

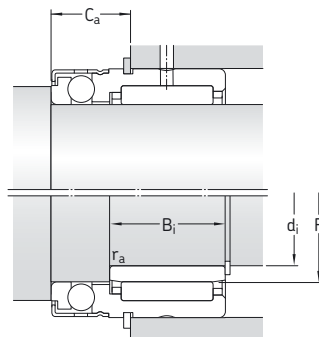
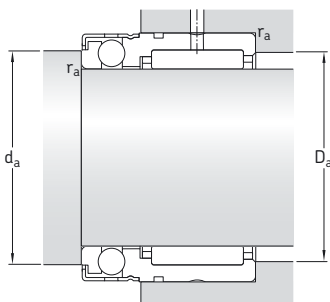

Dimensions				Abutment and fillet dimensions				Appropriate inner ring ²⁾ Dimensions				Appropriate snap ring ³⁾ Designation
F _w	C ₁	d	r _{1,2} min	d _a	D _a max	C _a	r _a max	d _i	F	B _i	Designation	
mm												
7	4,7	7	0,3	9,5	12	10	0,3	–	–	–	–	SW 14
	4,7	7	0,3	9,5	12	10	0,3	–	–	–	–	SW 14
10	4,7	10	0,3	14,5	17	10	0,3	6	10	10	IR 6×10×10 IS1	SW 19
	4,7	10	0,3	14,5	17	10	0,3	6	10	10	IR 6×10×10 IS1	SW 19
12	4,7	12	0,3	16,5	19	10	0,3	8	12	10	IR 8×12×10 IS1	SW 21
	4,7	12	0,3	16,5	19	10	0,3	8	12	10	IR 8×12×10 IS1	SW 21
15	8	15	0,3	19	22	12,2	0,3	12	15	16	IR 12×15×16	SW 24
	8	15	0,3	19	22	12,2	0,3	12	15	16	IR 12×15×16	SW 24
17	8	17	0,3	21	24	12,2	0,3	14	17	17	IR 14×17×17	SW 26
	8	17	0,3	21	24	12,2	0,3	14	17	17	IR 14×17×17	SW 26
20	8	20	0,3	25	28	12,2	0,3	17	20	16	IR 17×20×16	SW 30
	8	20	0,3	25	28	12,2	0,3	17	20	16	IR 17×20×16	SW 30
25	8	25	0,3	31,5	35	14,2	0,3	20	25	16	IR 20×25×16 IS1	SW 37
	8	25	0,3	31,5	35	14,2	0,3	20	25	16	IR 20×25×16 IS1	SW 37
30	10	30	0,3	36,5	40	14,2	0,3	25	30	20	IR 25×30×20	SW 42
	10	30	0,3	36,5	40	14,2	0,3	25	30	20	IR 30×35×20	SW 42
35	10	35	0,3	40,5	45	14,2	0,3	30	35	20	IR 25×30×20	SW 47
	10	35	0,3	40,5	45	14,2	0,3	30	35	20	IR 30×35×20	SW 47

²⁾ For additional information, refer to the section *Needle roller bearing inner rings*, starting on page 196.

³⁾ In accordance with DIN 471, not supplied by SKF

Needle roller / thrust ball bearings, thrust bearing with a cage

F_w 10 – 70 mm

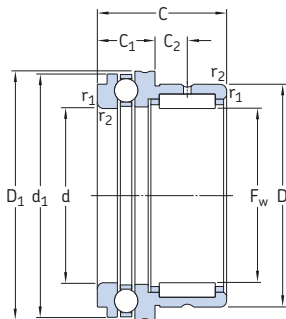

NKX

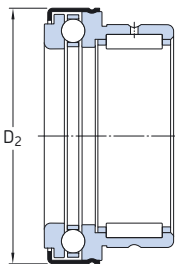

NKX..Z

Principal dimensions	Basic load ratings						Fatigue load limits		Min. load factor A	Speed ratings		Mass	Designation	
	F _w	D	C	radial C	dynamic C ₀	static C ₀	axial C	dynamic C ₀		radial P _u	axial P _u			Reference speed
mm	kN						kN		–	r/min		kg	–	
10	19	23	23	5,94	8	9,95	15,3	0,9	0,56	1,2	9 500	13 000	0,034	NKX 10 TN¹⁾ NKX 10 ZTN¹⁾
	19	23	23	5,94	8	9,95	15,3	0,9	0,56	1,2	9 500	8 000	0,036	
12	21	23	23	6,16	8,65	10,4	16,6	0,98	0,62	1,4	9 000	13 000	0,038	NKX 12 NKX 12 Z
	21	23	23	6,16	8,65	10,4	16,6	0,98	0,62	1,4	9 000	7 500	0,04	
15	24	23	23	11,2	14	10,6	18,3	1,66	0,67	1,7	8 500	12 000	0,044	NKX 15 NKX 15 Z
	24	23	23	11,2	14	10,6	18,3	1,66	0,67	1,7	8 500	7 000	0,047	
17	26	25	25	12,3	16,6	10,8	19,6	1,96	0,735	2	8 500	12 000	0,053	NKX 17 NKX 17 Z
	26	25	25	12,3	16,6	10,8	19,6	1,96	0,735	2	8 500	7 000	0,055	
20	30	30	30	16,8	26	14,3	27	3,05	1	3,8	7 500	10 000	0,083	NKX 20 NKX 20 Z
	30	30	30	16,8	26	14,3	27	3,05	1	3,8	7 500	6 000	0,09	
25	37	30	19	32,5	19,5	40,5	4	4	1,5	8,5	6 300	9 000	0,13	NKX 25 NKX 25 Z
	37	30	19	32,5	19,5	40,5	4	4	1,5	8,5	6 300	5 500	0,13	
30	42	30	22,9	39	20,3	45,5	4,8	4,8	1,7	10	6 000	8 500	0,14	NKX 30 NKX 30 Z
	42	30	22,9	39	20,3	45,5	4,8	4,8	1,7	10	6 000	5 000	0,15	
35	47	30	24,6	45	21,2	51	5,6	5,6	1,9	13	5 600	7 500	0,16	NKX 35 NKX 35 Z
	47	30	24,6	45	21,2	51	5,6	5,6	1,9	13	5 600	4 500	0,17	
40	52	32	26,4	51	27	68	6,3	6,3	2,55	24	5 000	7 000	0,2	NKX 40 NKX 40 Z
	52	32	26,4	51	27	68	6,3	6,3	2,55	24	5 000	4 000	0,21	
45	58	32	28,1	57	28,1	75	7,1	7,1	2,8	29	4 500	6 300	0,25	NKX 45 NKX 45 Z
	58	32	28,1	57	28,1	75	7,1	7,1	2,8	29	4 500	3 800	0,27	
50	62	35	38	80	28,6	81,5	9,65	9,65	3,05	34	4 300	6 300	0,28	NKX 50 NKX 50 Z
	62	35	38	80	28,6	81,5	9,65	9,65	3,05	34	4 300	3 600	0,3	
60	72	40	41,8	96,5	41,6	122	11,8	11,8	4,55	77	3 600	5 000	0,36	NKX 60 NKX 60 Z
	72	40	41,8	96,5	41,6	122	11,8	11,8	4,55	77	3 600	3 000	0,38	
70	85	40	44,6	98	43,6	137	12,2	12,2	5,1	97	3 400	4 500	0,5	NKX 70 NKX 70 Z
	85	40	44,6	98	43,6	137	12,2	12,2	5,1	97	3 400	2 700	0,52	

¹⁾ Radial bearing with inserted closure ring

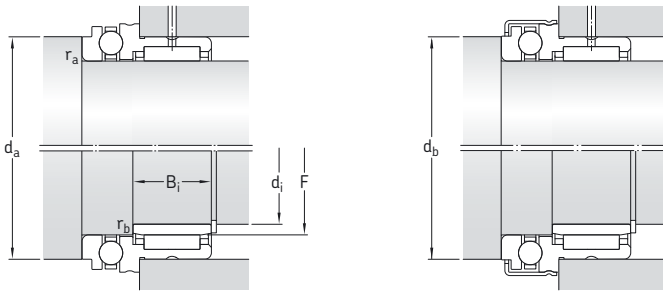

Dimensions								Abutment and fillet dimensions							Appropriate inner ring ²⁾ Designation
F _w	C ₁	C ₂	d	d ₁	D ₁	D ₂	r _{1,2} min	d _a min	d _b max	r _a max	r _b max	d _i	F	B _i	
mm								mm							–
10	9	6,5	10	24	24	–	0,3	19	–	0,3	0,3	7	10	16	IR 7×10×16
	9	6,5	10	19,7	–	25,2	0,3	19	19,7	0,3	0,3	7	10	16	IR 7×10×16
12	9	6,5	12	26	26	–	0,3	21	–	0,3	0,3	9	12	16	IR 9×12×16
	9	6,5	12	21,7	–	27,2	0,3	21	21,7	0,3	0,3	9	12	16	IR 9×12×16
15	9	6,5	15	28	28	–	0,3	23	–	0,3	0,3	12	15	16	IR 12×15×16
	9	6,5	15	23,7	–	29,2	0,3	23	23,7	0,3	0,3	12	15	16	IR 12×15×16
17	9	8	17	30	30	–	0,3	25	–	0,3	0,3	14	17	17	IR 14×17×17
	9	8	17	25,7	–	31,1	0,3	25	25,7	0,3	0,3	14	17	17	IR 14×17×17
20	10	10,5	20	35	35	–	0,3	29	–	0,3	0,3	17	20	20	IR 17×20×20
	10	10,5	20	30,7	–	36,2	0,3	29	30,7	0,3	0,3	17	20	20	IR 17×20×20
25	11	9,5	25	42	42	–	0,6	35	–	0,6	0,3	20	25	20	IR 20×25×20
	11	9,5	25	37,7	–	43,2	0,6	35	37,7	0,6	0,3	20	25	20	IR 20×25×20
30	11	9,5	30	47	47	–	0,6	40	–	0,6	0,3	25	30	20	IR 25×30×20
	11	9,5	30	42,7	–	48,2	0,6	40	42,7	0,6	0,3	25	30	20	IR 25×30×20
35	12	9	35	52	52	–	0,6	45	–	0,6	0,3	30	35	20	IR 30×35×20
	12	9	35	47,7	–	53,2	0,6	45	47,7	0,6	0,3	30	35	20	IR 30×35×20
40	13	10	40	60	60	–	0,6	52	–	0,6	0,3	35	40	20	IR 35×40×20
	13	10	40	55,7	–	61,2	0,6	52	55,7	0,6	0,3	35	40	20	IR 35×40×20
45	14	9	45	65	65	–	0,6	57	–	0,6	0,3	40	45	20	IR 40×45×20
	14	9	45	60,5	–	66,5	0,6	57	60,5	0,6	0,3	40	45	20	IR 40×45×20
50	14	10	50	70	70	–	0,6	62	–	0,6	0,3	45	50	25	IR 45×50×25
	14	10	50	65,5	–	71,5	0,6	62	65,5	0,6	0,3	45	50	25	IR 45×50×25
60	17	12	60	85	85	–	1	75	–	1	1	50	60	25	IR 50×60×25
	17	12	60	80,5	–	86,5	1	75	80,5	1	1	50	60	25	IR 50×60×25
70	18	11	70	95	95	–	1	85	–	1	1	60	70	25	IR 60×70×25
	18	11	70	90,5	–	96,5	1	85	90,5	1	1	60	70	25	IR 60×70×25

²⁾ For additional information, refer to the section *Needle roller bearing inner rings*, starting on **page 196**.

Needle roller / cylindrical roller thrust bearings

Needle roller / cylindrical roller thrust bearings combine a radial needle roller bearing and a cylindrical roller thrust bearing based on the 811 series. SKF supplies these bearings in the following two series:

- NKXR series (→ **fig. 19**), cylindrical roller thrust bearing is separable
- NKXR .. Z series (→ **fig. 20**), non-separable bearing

These bearings are supplied without an inner ring. For applications where it is not possible to harden and grind the shaft, the bearings can be combined with an inner ring (→ **fig. 21**). Appropriate inner rings are listed in the product tables and can be ordered separately.

Needle roller / cylindrical roller thrust bearings, NKXR series

SKF needle roller / cylindrical roller thrust bearings in the NKXR series (→ **fig. 19**) are separable. Both the cylindrical roller and cage thrust assembly and shaft washer can be mounted separately from the rest of the bearing.

Needle roller / cylindrical roller thrust bearings, NKXR .. Z series

SKF needle roller / cylindrical roller thrust bearings in the NKXR .. Z series (→ **fig. 20**) are non-separable. They have a stamped steel cover that extends over the shaft washer of the cylindrical roller thrust bearing. It is firmly attached to the housing washer that is integral to the needle roller bearing outer ring. The cover makes these bearings non-separable. SKF supplies the cylindrical roller thrust bearing in this series filled, as standard, with a high-quality grease that has good rust inhibiting properties. The cover, which has no lubrication holes, forms a gap-type seal with the shaft washer to retain the grease in the bearing.

Fig. 19

Needle roller / cylindrical roller thrust bearing

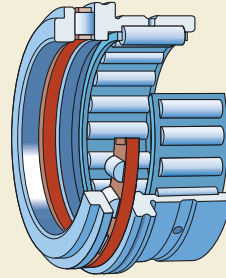

NKXR series

Fig. 20

Needle roller / cylindrical roller thrust bearing

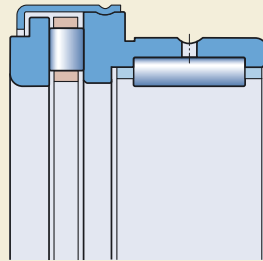

NKXR .. Z series

Fig. 21

Needle roller / cylindrical roller thrust bearing, NKXR .. Z series, combined with an inner ring

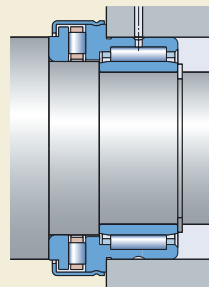

Dimensions

The boundary dimensions of the single direction needle roller / cylindrical roller thrust bearings are in accordance with DIN 5429-1:2005-08.

Tolerances

SKF needle roller / cylindrical roller thrust bearings are manufactured to the tolerances and tolerance classes listed in **table 3**. The radial runout values are in accordance with ISO 492:2002 and the axial runout values are in accordance with Normal tolerance class of ISO 199:2005.

The values for the deviations from the nominal diameter of the ISO tolerance classes F6 and E8 in **table 3** are listed in **table 4**.

Shaft and housing tolerances

SKF recommends machining the shaft seat for needle roller / cylindrical roller thrust bearings to a k5 tolerance class for bearings with or without an inner ring.

For the housing bore seat, SKF recommends a K6 tolerance class. For stiff bearing arrangements, SKF recommends an M6 housing bore tolerance class.

In addition to their interference fit on the shaft and in the housing, the bearing rings must be axially located by a shaft shoulder or locating ring.

Internal clearance

SKF needle roller / cylindrical roller thrust bearings combined with the appropriate inner ring, as listed in the product tables, have Normal radial internal clearance as standard. The clearance values are listed in **table 7** on **page 42** and are in accordance with ISO 5753:1991. They are valid for unmounted bearings under zero measuring load.

The radial internal clearance for SKF needle roller / cylindrical roller thrust bearings without an inner ring depends on the shaft tolerance. If the recommended k5 shaft tolerance class is applied, the tolerance for the inside diameter F_w will provide an internal clearance that is slightly less than the Normal radial internal clearance.

Table 3

Needle roller / cylindrical roller thrust bearing tolerances

Dimension ¹⁾		Tolerance, tolerance class
Outside diameter	D	Normal, ISO 492:1994
Inside diameter of needle roller complement	F_w	F6
Bore diameter	d	E8
Width	C	0/-0,25 mm
Width	C_1	0/-0,20 mm

¹⁾ Refer to the illustrations in the product table on **page 192**

Table 4

ISO tolerance classes

Nominal diameter	E8	Deviations		F6	
		high	low	high	low
over incl.					
mm		μm		μm	
6	10	+47	+25	+22	+13
10	18	+59	+32	+27	+16
18	30	+73	+40	+33	+20
30	50	+89	+50	+41	+25
50	80	+106	+60	+49	+30

Misalignment

Needle roller / cylindrical roller thrust bearings cannot accommodate any angular misalignment of the shaft relative to the housing, or between the axial support surfaces on the shaft or in the housing.

Cages

The radial needle roller bearing is fitted as standard with a machined steel cage (→ **fig. 4, page 172**) or a sheet steel cage (→ **fig. 5, page 172**).

The cage that retains the rollers of the cylindrical roller thrust bearing is made of glass fibre reinforced polyamide 66 (→ **fig. 22**).

Note

Needle roller / cylindrical roller thrust bearings should not be operated at temperatures above 120 °C.

The lubricants generally used for rolling bearings do not have a detrimental effect on cage properties. Exceptions are a few synthetic oils and greases with a synthetic oil base and lubricants containing a high proportion of EP additives when used at high temperatures.

For detailed information about the temperature resistance and the applicability of cages, refer to the section *Cage materials*, starting on **page 44**.

Lubrication

To promote efficient lubrication, SKF needle roller / cylindrical roller thrust bearings have an annular groove with lubrication holes in the outer ring of the needle roller bearing.

The shielded thrust bearing of needle roller / cylindrical roller thrust bearings, in the NKXR ..Z series, is filled at the factory with a high-quality grease with good corrosion inhibiting properties. SKF recommends SKF LGWA 2 grease for relubrication. For additional information about greases, refer to the section *Lubrication*, starting on **page 52**.

Bearings in the NKXR series, without the designation suffix Z, should be oil lubricated whenever possible, as oil facilitates an adequate supply of lubricant to the bearing.

Relubrication intervals for the needle roller bearing and cylindrical roller thrust bearing must be calculated separately. The lower of the two intervals should be used. A calculation is necessary for both oil and grease lubrication.

Fig. 22

Polyamide 66 cage of the cylindrical roller thrust bearing



Design of associated components

The diameter of the support surface for the integral housing washer of needle roller / cylindrical roller thrust bearings must always be at least 0,5 mm larger than the dimension D_1 or D_2 (→ **fig. 23**) to obtain a clearance fit. The values for the diameters D_1 and D_2 are listed in the product table.

Application recommendations

SKF needle roller / cylindrical roller thrust bearings can locate a shaft axially in one direction. For short shafts, where changes in length as a result of thermal expansion are relatively minor, two bearings can be used in a back-to-back (mirrored) arrangement (→ **fig. 24**). In these cases, SKF recommends elastically preloading the cylindrical roller thrust bearings with cup springs (belleville washers). This elastic preload helps to avoid skidding of the rolling elements when one of the thrust bearings is unloaded. Elastic preload also reduces the noise level of the cylindrical roller thrust bearing.

Supplementary designations

The designation suffixes used to identify certain features of SKF needle roller / cylindrical roller thrust bearings are explained in the following.

- Z** Cylindrical roller thrust bearing with a cover over the outside diameter without lubrication holes. Filled at the factory with a high-quality lithium base NLGI 2 grease.

Fig. 23

Clearance fit for the integral housing washer

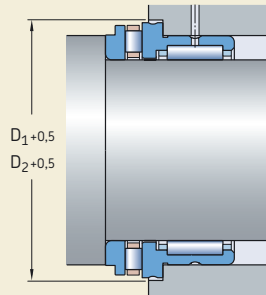
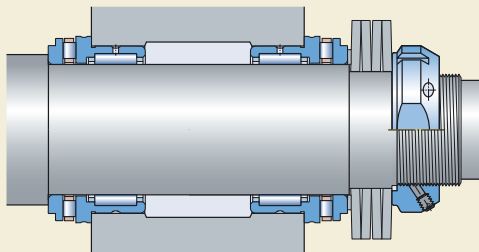

Fig. 24

NKXR series, back-to-back arrangement



Needle roller / cylindrical roller thrust bearings

F_w 15 – 50 mm

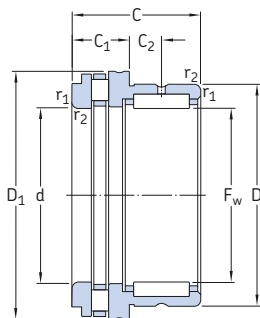

NKXR

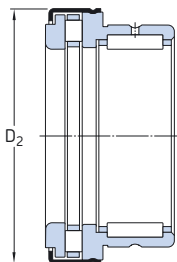

NKXR..Z

Principal dimensions	Basic load ratings						Fatigue load limits		Min. load factor A	Speed ratings		Mass	Designation
	F _w	D	C	radial dynamic C	static C ₀	axial dynamic C	static C ₀	radial P _u		axial P _u	Reference speed		
mm	kN						kN		–	r/min		kg	–
15	24	23	11,2	14	11,2	27	1,66	2,45	0,058	4 300	8 500	0,042	NKXR 15
	24	23	11,2	14	11,2	27	1,66	2,45	0,058	4 300	8 500	0,045	NKXR 15 Z
17	26	25	12,3	16,6	12,2	31,5	1,96	2,85	0,079	4 300	8 500	0,05	NKXR 17
	26	25	12,3	16,6	12,2	31,5	1,96	2,85	0,079	4 300	8 500	0,053	NKXR 17 Z
20	30	30	16,8	26	18,6	48	3,05	4,65	0,18	3 800	7 500	0,08	NKXR 20
	30	30	16,8	26	18,6	48	3,05	4,65	0,18	3 800	7 500	0,084	NKXR 20 Z
25	37	30	19	32,5	25	69,5	4	6,8	0,39	3 200	6 300	0,12	NKXR 25
	37	30	19	32,5	25	69,5	4	6,8	0,39	3 200	6 300	0,13	NKXR 25 Z
30	42	30	22,9	39	27	78	4,8	7,65	0,49	3 000	6 000	0,14	NKXR 30
	42	30	22,9	39	27	78	4,8	7,65	0,49	3 000	6 000	0,14	NKXR 30 Z
35	47	30	24,6	45	29	93	5,6	9,15	0,69	2 800	5 600	0,16	NKXR 35
	47	30	24,6	45	29	93	5,6	9,15	0,69	2 800	5 600	0,17	NKXR 35 Z
40	52	32	26,4	51	43	137	6,3	13,7	1,5	2 400	5 000	0,2	NKXR 40
	52	32	26,4	51	43	137	6,3	13,7	1,5	2 400	5 000	0,21	NKXR 40 Z
45	58	32	28,1	57	45	153	7,1	15,3	1,9	2 200	4 500	0,24	NKXR 45
	58	32	28,1	57	45	153	7,1	15,3	1,9	2 200	4 500	0,26	NKXR 45 Z
50	62	35	38	80	47,5	166	9,65	16,6	2,2	2 200	4 300	0,27	NKXR 50
	62	35	38	80	47,5	166	9,65	16,6	2,2	2 200	4 300	0,29	NKXR 50 Z

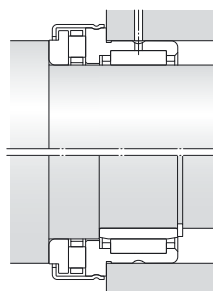
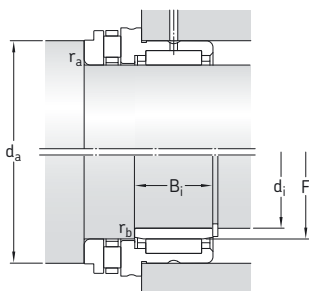

Dimensions							Abutment and fillet dimensions						Appropriate inner ring ¹⁾ Designation
F _w	C ₁	C ₂	d	D ₁	D ₂	r _{1,2} min	d _a	r _a max	r _b max	d _i	F	B _i	
mm							mm						-
15	9	6,5	15	28	-	0,3	23,7	0,3	0,3	12	15	16	IR 12×15×16
	9	6,5	15	-	29,2	0,3	23,7	0,3	0,3	12	15	16	IR 12×15×16
17	9	8	17	30	-	0,3	25,7	0,3	0,3	14	17	17	IR 14×17×17
	9	8	17	-	31,2	0,3	25,7	0,3	0,3	14	17	17	IR 14×17×17
20	10	10,5	20	35	-	0,3	30,7	0,3	0,3	17	20	20	IR 17×20×20
	10	10,5	20	-	36,2	0,3	30,7	0,3	0,3	17	20	20	IR 17×20×20
25	11	9,5	25	42	-	0,6	37,7	0,6	0,3	20	25	20	IR 20×25×20
	11	9,5	25	-	43,2	0,6	37,7	0,6	0,3	20	25	20	IR 20×25×20
30	11	9,5	30	47	-	0,6	42,7	0,6	0,3	25	30	20	IR 25×30×20
	11	9,5	30	-	48,2	0,6	42,7	0,6	0,3	25	30	20	IR 25×30×20
35	12	9	35	52	-	0,6	47,7	0,6	0,3	30	35	20	IR 30×35×20
	12	9	35	-	53,2	0,6	47,7	0,6	0,3	30	35	20	IR 30×35×20
40	13	10	40	60	-	0,6	55,7	0,6	0,3	35	40	20	IR 35×40×20
	13	10	40	-	61,2	0,6	55,7	0,6	0,3	35	40	20	IR 35×40×20
45	14	9	45	65	-	0,6	60,6	0,6	0,3	40	45	20	IR 40×45×20
	14	9	45	-	66,5	0,6	60,6	0,6	0,3	40	45	20	IR 40×45×20
50	14	10	50	70	-	0,6	65,6	0,6	0,3	45	50	25	IR 45×50×25
	14	10	50	-	71,5	0,6	65,6	0,6	0,3	45	50	25	IR 45×50×25

¹⁾ For additional information, refer to the section *Needle roller bearing inner rings*, starting on page 196.



Needle roller bearing components

Needle roller bearing inner rings	196
Inner rings in the IR series	196
Tolerances	196
Internal clearance	197
Raceways with a machining allowance	197
Inner rings in the LR series	197
Tolerances	198
Inner ring seats	198
Shaft diameter tolerances	198
Cylindricity	198
Runout	198
Supplementary designations	199
Product tables	200
8.1 Needle roller bearing inner rings	200
Needle rollers	204
Materials	204
Tolerances	204
Supplementary designations	205
Product tables	206
8.2 Needle rollers	206
Radial shaft seals with a low cross sectional height	208
G design radial shaft seals	208
SD design radial shaft seals	208
Design of associated components	209
Speeds	210
Operating temperature range	210
Mounting instructions	210
Product tables	212
8.3 Radial shaft seals with a low cross sectional height	212

Needle roller bearing inner rings

SKF supplies inner rings for needle roller bearings separately. They are primarily used in conjunction with needle roller and cage assemblies and drawn cup needle roller bearings in applications where the shaft cannot be ground and hardened to a suitable raceway tolerance. Extended inner rings are also available. These permit greater axial displacement of the shaft, relative to the housing, compared to standard width inner rings. They also provide an excellent counterface for the lips of contact seals.

SKF supplies needle roller bearing inner rings in the following two series:

- inner rings in the IR series (→ **fig. 1**), with or without a lubrication hole, with or without machining allowance
- inner rings in the LR series (→ **fig. 2**).

Regardless of whether the ring has an interference or loose fit, it should be located to the shaft by either a shoulder or snap ring to prevent axial movements.

Inner rings in the IR series

Inner rings in the IR series (→ **fig. 1**) are the standard SKF inner rings for needle roller bearings. They are made of carbon chromium bearing steel that has been hardened and ground. The raceway surface, which is precision machined, has a lead-in chamfer on both sides to simplify assembly. The chamfer also protects the sealing lips from damage during the mounting process.

Some sizes of IR inner rings have a lubrication hole (→ **fig. 3**). These inner rings are identified by the designation suffix IS1. Inner rings with additional lubrication holes are available on request.

Tolerances

The bore diameter and the width of IR inner rings are made to Normal tolerances in accordance with ISO 492:2002.

Fig. 1

Inner ring

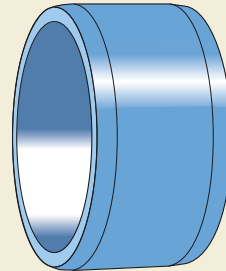

IR series

Fig. 2

Inner ring

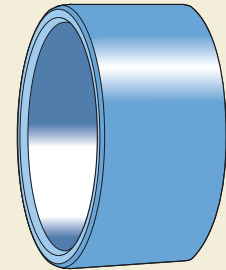

LR series

Fig. 3

Inner ring, with a lubrication hole

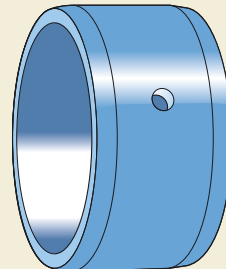

IR .. IS1 series

Internal clearance

If the recommended shaft and housing tolerance classes are applied, the tolerances for the inner ring raceway diameter F will provide applications with the following internal clearance:

- a suitable (medium) operational clearance that will reach a value in the range of C2 to C3 radial internal clearance, when combined with SKF drawn cup needle roller bearings. The clearance value depends on the raceway diameter and the operating temperature.
- a Normal radial internal clearance, when combined with SKF needle roller bearings with a machined outer ring. The clearance values are listed in **table 7** on **page 42** and are in accordance with ISO 5753:1991. They are valid for unmounted bearings under zero measuring load.

Raceways with a machining allowance

On request, SKF can supply inner rings in the IR series with a pre-ground raceway and a machining allowance z . These inner rings are identified by the designation suffix VGS. The machining allowance depends on the inner ring raceway diameter and is listed in **table 1**.

Inner rings in the LR series

Inner rings in the LR series (→ **fig. 2**, **page 196**) are made of carbon chromium bearing steel and have been hardened. The bore and outside diameter are ground. The side faces are turned and the edges are smoothed. Therefore, they have larger tolerances than inner rings in the IR series. For applications where the larger run-out and width tolerances are less important, these inner rings can be used to provide a cost-effective bearing arrangement. They are, therefore, often combined with drawn cup needle roller bearings or needle roller and cage assemblies (→ **fig. 4**).

Table 1

Inner ring raceway diameter

Raceway diameter F		Machining allowance z	Preground raceway diameter F_{VGS}
over	incl.		
mm		mm	mm
–	50	0,10	$F_{VGS} = F + z$ h7 tolerance class
50	80	0,15	
80	180	0,20	
180	250	0,25	
250	315	0,30	
315	400	0,35	
400	500	0,40	

Fig. 4

Inner ring, LR series, combined with a needle roller and cage assembly

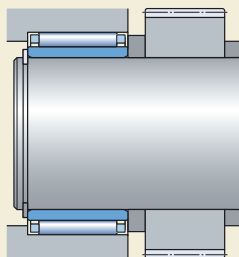

Needle roller bearing inner rings

Tolerances

SKF inner rings in the LR series are manufactured to the following tolerance classes:

- raceway diameter to h6 tolerance class
- width to h12 tolerance class
- bore diameter to K6 tolerance class.

The values for the deviation from the nominal dimension for these tolerances are provided in **table 2**.

Inner ring seats

The seat for an inner ring mounted on a shaft should be in accordance with the following recommendations.

Shaft diameter tolerances

When inner rings are used under conditions of point load and mounted with a loose fit, the seat should be machined to h6 or g6 tolerance class.

When the load rotates, the inner rings should have an interference fit. Sufficient interference can be obtained if the recommended shaft tolerance classes (→ **table 3, page 105**) are applied.

Cylindricity

The cylindricity of an inner ring seat should be in accordance with ISO 1101:2004, corresponding to the following IT tolerance classes:

- IT5/2 for inner rings under point load
- IT4/2 for inner rings under rotating load.

Runout

Inner ring shaft abutments should have a runout corresponding to IT4 tolerance class.

Table 2

ISO tolerance classes for LR series inner rings

Nominal diameter	over incl.	h6		h12		K6	
		Deviations high	low	Deviations high	low	Deviations high	low
mm		μm		μm		μm	
6	10	0	-9	0	-150	+2	-7
10	18	0	-11	0	-180	+2	-9
18	30	0	-13	0	-210	+2	-11
30	50	0	-16	0	-250	+3	-13
50	80	0	-19	0	-300	+4	-15

Supplementary designations

The designation suffixes used to identify certain features of SKF needle roller bearing inner rings are explained in the following.

- EGS** Inner ring with non-directionally ground raceway
- IS..** Needle roller bearing with one or more lubricating holes in the inner ring, a figure following indicates the number of holes
- ISR..** Needle roller bearing with an annular groove and one or more lubricating holes in the inner ring, a figure following indicates the number of holes
- VGS** Inner ring with a pre-ground raceway and a machining allowance
- C2** Bearing internal clearance smaller than Normal
- C3** Bearing internal clearance greater than Normal
- C4** Bearing internal clearance greater than C3

Needle roller bearing inner rings
d 5 – 42 mm

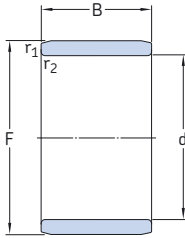

IR



IR .. IS1

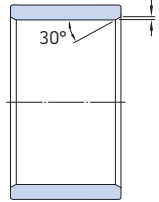

LR

Dimensions				Mass	Designation
d	F	B	r, r _{1,2}		
mm				kg	-
5	8	12	0,3	0,0028	IR 5×8×12
	8	16	0,3	0,0038	IR 5×8×16
6	9	12	0,3	0,0032	IR 6×9×12
	9	16	0,3	0,0043	IR 6×9×16
	10	10	0,3	0,0037	IR 6×10×10 IS1
7	10	10,5	0,3	0,0031	IR 7×10×10,5
	10	10,5	0,3	0,0031	LR 7×10×10,5
	10	12	0,3	0,0036	IR 7×10×12
	10	16	0,3	0,0049	IR 7×10×16
8	12	10	0,3	0,0048	IR 8×12×10 IS1
	12	10,5	0,3	0,005	IR 8×12×10,5
	12	10,5	0,3	0,005	LR 8×12×10,5
	12	12,5	0,3	0,0059	IR 8×12×12,5
	12	12,5	0,3	0,0059	LR 8×12×12,5
9	12	12	0,3	0,0045	IR 9×12×12
	12	16	0,3	0,0061	IR 9×12×16
10	13	12,5	0,3	0,0052	IR 10×13×12,5
	13	12,5	0,3	0,0052	LR 10×13×12,5
	14	12	0,3	0,0073	IR 10×14×12 IS1
	14	13	0,3	0,0074	IR 10×14×13
	14	16	0,3	0,0092	IR 10×14×16
12	14	20	0,3	0,012	IR 10×14×20
	15	12	0,3	0,0058	IR 12×15×12
	15	12,5	0,3	0,0061	IR 12×15×12,5
	15	12,5	0,3	0,0061	LR 12×15×12,5
	15	16	0,3	0,008	IR 12×15×16
	15	16,5	0,3	0,0081	IR 12×15×16,5
	15	16,5	0,3	0,0081	LR 12×15×16,5
	15	22,5	0,3	0,011	IR 12×15×22,5
	15	22,5	0,3	0,011	LR 12×15×22,5
	16	12	0,3	0,0079	IR 12×16×12 IS1
	16	13	0,3	0,0087	IR 12×16×13
	16	16	0,3	0,011	IR 12×16×16
16	20	0,3	0,014	IR 12×16×20	
16	22	0,3	0,015	IR 12×16×22	

Dimensions				Mass	Designation
d	F	B	r, r _{1,2}		
mm				kg	-
14	17	17	0,3	0,01	IR 14×17×17
15	18	12,5	0,3	0,0072	LR 15×18×12,5
	18	16	0,3	0,0096	IR 15×18×16
	18	16,5	0,3	0,0099	IR 15×18×16,5
	18	16,5	0,3	0,0099	LR 15×18×16,5
	19	16	0,3	0,013	IR 15×19×16
	19	20	0,3	0,016	IR 15×19×20
	20	12	0,3	0,012	IR 15×20×12 IS1
17	20	13	0,3	0,014	IR 15×20×13
	20	23	0,3	0,024	IR 15×20×23
	20	16	0,3	0,011	IR 17×20×16
	20	16,5	0,3	0,011	IR 17×20×16,5
	20	16,5	0,3	0,011	LR 17×20×16,5
	20	20	0,3	0,014	IR 17×20×20
	20	20,5	0,3	0,014	IR 17×20×20,5
	20	20,5	0,3	0,014	LR 17×20×20,5
	20	30,5	0,3	0,021	IR 17×20×30,5
	20	30,5	0,3	0,021	LR 17×20×30,5
	21	16	0,3	0,014	IR 17×21×16
20	21	20	0,3	0,018	IR 17×21×20
	22	13	0,3	0,015	IR 17×22×13
	22	16	0,3	0,019	IR 17×22×16
	22	23	0,3	0,027	IR 17×22×23
	24	20	0,3	0,034	IR 17×24×20
	24	16	0,3	0,017	IR 20×24×16
	24	20	0,3	0,021	IR 20×24×20
25	12,5	0,3	0,016	LR 20×25×12,5	
25	16	0,3	0,021	IR 20×25×16 IS1	
25	16,5	0,3	0,022	LR 20×25×16,5	
25	17	0,3	0,022	IR 20×25×17	
25	20	0,3	0,028	IR 20×25×20	
25	20,5	0,3	0,028	IR 20×25×20,5	
25	20,5	0,3	0,028	LR 20×25×20,5	
25	26,5	0,3	0,036	IR 20×25×26,5	
25	26,5	0,3	0,036	LR 20×25×26,5	
25	30	0,3	0,041	IR 20×25×30	
25	38,5	0,3	0,053	IR 20×25×38,5	
25	38,5	0,3	0,053	LR 20×25×38,5	
28	20	0,6	0,045	IR 20×28×20	

Dimensions				Mass	Designation
d	F	B	r, r _{1,2}		
mm				kg	–
22	26	16	0,3	0,018	IR 22×26×16
	26	20	0,3	0,023	IR 22×26×20
	28	17	0,3	0,03	IR 22×28×17
	28	20	0,3	0,035	IR 22×28×20
	28	20,5	0,3	0,036	IR 22×28×20.5
	28	20,5	0,3	0,036	LR 22×28×20.5
	28	30	0,3	0,054	IR 22×28×30
	25	29	20	0,3	0,026
29		30	0,3	0,039	IR 25×29×30
30		12,5	0,3	0,02	LR 25×30×12.5
30		16	0,3	0,026	IR 25×30×16 IS1
30		16,5	0,3	0,027	LR 25×30×16.5
30		17	0,3	0,028	IR 25×30×17
30		20	0,3	0,033	IR 25×30×20
30		20,5	0,3	0,034	IR 25×30×20.5
30		20,5	0,3	0,034	LR 25×30×20.5
30		26,5	0,3	0,043	IR 25×30×26.5
30		26,5	0,3	0,043	LR 25×30×26.5
30		30	0,3	0,05	IR 25×30×30
30		32	0,3	0,053	IR 25×30×32
30		38,5	0,3	0,064	IR 25×30×38.5
30		38,5	0,3	0,064	LR 25×30×38.5
32		22	0,6	0,052	IR 25×32×22
28	32	17	0,3	0,025	IR 28×32×17
	32	20	0,3	0,028	IR 28×32×20
	32	30	0,3	0,044	IR 28×32×30
	30	35	12,5	0,3	0,023
35		13	0,3	0,025	IR 30×35×13
35		16	0,3	0,031	IR 30×35×16
35		16,5	0,3	0,031	LR 30×35×16.5
35		17	0,3	0,032	IR 30×35×17
35		20	0,3	0,04	IR 30×35×20
35		20,5	0,3	0,041	IR 30×35×20.5
35		20,5	0,3	0,041	LR 30×35×20.5
35		26	0,3	0,05	IR 30×35×26
35		30	0,3	0,059	IR 30×35×30
37		18	0,6	0,05	IR 30×37×18
37		22	0,6	0,061	IR 30×37×22
38		20	0,6	0,065	IR 30×38×20 IS1

Dimensions				Mass	Designation
d	F	B	r, r _{1,2}		
mm				kg	–
32	37	20	0,3	0,042	IR 32×37×20
	37	30	0,3	0,063	IR 32×37×30
	40	20	0,6	0,068	IR 32×40×20
	40	36	0,6	0,12	IR 32×40×36
	33	37	13	0,3	0,022
35		40	12,5	0,3	0,027
	40	16,5	0,3	0,037	LR 35×40×16.5
	40	17	0,3	0,038	IR 35×40×17
	40	20	0,3	0,044	IR 35×40×20
	40	20,5	0,3	0,046	IR 35×40×20.5
	40	20,5	0,3	0,046	LR 35×40×20.5
	40	30	0,3	0,068	IR 35×40×30
	42	20	0,6	0,064	IR 35×42×20 IS1
38	42	36	0,6	0,12	IR 35×42×36
	43	22	0,6	0,082	IR 35×43×22
38	43	20	0,3	0,048	IR 38×43×20
	43	30	0,3	0,074	IR 38×43×30
40	45	16,5	0,3	0,041	LR 40×45×16.5
	45	17	0,3	0,043	IR 40×45×17
	45	20	0,3	0,051	IR 40×45×20
	45	20,5	0,3	0,053	IR 40×45×20.5
	45	20,5	0,3	0,053	LR 40×45×20.5
	45	30	0,3	0,077	IR 40×45×30
	48	22	0,6	0,092	IR 40×48×22
	48	40	0,6	0,17	IR 40×48×40
42	50	20	1	0,11	IR 40×50×20 IS1
	50	22	1	0,12	IR 40×50×22
	47	20	0,3	0,054	IR 42×47×20
47	30	0,3	0,081	IR 42×47×30	

Needle roller bearing inner rings

d 45 – 380 mm

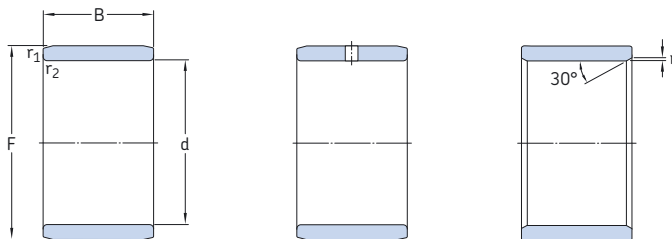

IR

IR .. IS1

LR

Dimensions					Mass	Designation	Dimensions					Mass	Designation	
d	F	B	r _{1,2}				d	F	B	r _{1,2}				
mm					kg	-	mm					kg	-	
45	50	20,5	0,3		0,058	LR 45×50×20,5	75	85	25	1		0,24	IR 75×85×25	
	50	25	0,6		0,071	IR 45×50×25		85	30	1		0,29	IR 75×85×30	
	50	25,5	0,3		0,074	IR 45×50×25,5		85	35	1		0,34	IR 75×85×35	
	50	25,5	0,3		0,074	LR 45×50×25,5		85	54	1		0,52	IR 75×85×54	
	50	35	0,6		0,1	IR 45×50×35		80	90	25	1		0,25	IR 80×90×25
	52	22	0,6		0,089	IR 45×52×22			90	30	1		0,3	IR 80×90×30
	52	40	0,6		0,16	IR 45×52×40			90	35	1		0,36	IR 80×90×35
	55	20	1		0,12	IR 45×55×20 IS1			90	54	1		0,55	IR 80×90×54
	55	22	1		0,13	IR 45×55×22			85	95	26	1		0,28
50	55	20	0,6		0,063	IR 50×55×20 IS1	95	36		1		0,39	IR 85×95×36	
	55	20,5	0,6		0,064	LR 50×55×20,5	100	35		1,1		0,58	IR 85×100×35	
	55	25	0,6		0,078	IR 50×55×25	100	63		1,1		1,05	IR 85×100×63	
	55	35	0,6		0,11	IR 50×55×35	90	100		26	1		0,29	IR 90×100×26
	58	22	0,6		0,12	IR 50×58×22		100		30	1		0,34	IR 90×100×30
	58	40	0,6		0,21	IR 50×58×40		100	36	1		0,41	IR 90×100×36	
	60	20	1		0,13	IR 50×60×20 IS1		105	35	1,1		0,61	IR 90×105×35	
	60	25	1		0,16	IR 50×60×25		105	63	1,1		1,1	IR 90×105×63	
	60	28	1		0,18	IR 50×60×28		95	105	26	1		0,31	IR 95×105×26
55	60	25	0,6		0,086	IR 55×60×25	105		36	1		0,43	IR 95×105×36	
	60	35	0,6		0,12	IR 55×60×35	110		35	1,1		0,64	IR 95×110×35	
	63	25	1		0,14	IR 55×63×25	110		63	1,1		1,15	IR 95×110×63	
	63	45	1		0,26	IR 55×63×45	100	110	30	1,1		0,37	IR 100×110×30	
	65	28	1,1		0,2	IR 55×65×28		110	40	1,1		0,51	IR 100×110×40	
	68	25	1		0,15	IR 60×68×25		115	40	1,1		0,78	IR 100×115×40	
	68	35	0,6		0,21	IR 60×68×35		110	120	30	1		0,41	IR 110×120×30
	68	45	1		0,28	IR 60×68×45			125	40	1,1		0,84	IR 110×125×40
	70	25	1		0,2	IR 60×70×25			120	130	30	1		0,44
70	28	1,1		0,22	IR 60×70×28	135	45	1,1			1	IR 120×135×45		
65	72	25	1		0,14	IR 65×72×25	130	145		35	1,1		0,86	IR 130×145×35
	72	45	1		0,26	IR 65×72×45		150	50	1,5		1,7	IR 130×150×50	
	73	25	1		0,16	IR 65×73×25		140	155	35	1,1		0,92	IR 140×155×35
	73	35	1		0,23	IR 65×73×35	160		50	1,5		1,8	IR 140×160×50	
	75	28	1,1		0,23	IR 65×75×28	70		80	25	1		0,22	IR 70×80×25
	80	30	1		0,27	IR 70×80×30		80	35	1		0,31	IR 70×80×35	
80	35	1		0,31	IR 70×80×35	80		54	1		0,49	IR 70×80×54		
80	54	1		0,49	IR 70×80×54									

Dimensions			Mass		Designation
d	F	B	r, r _{1,2}		
mm			kg		-
150	165	40	1,1	1,1	IR 150×165×40
160	175	40	1,1	1,2	IR 160×175×40
170	185	45	1,1	1,45	IR 170×185×45
180	195	45	1,1	1,5	IR 180×195×45
190	210	50	1,5	2,4	IR 190×210×50
200	220	50	1,5	2,5	IR 200×220×50
220	240	50	1,5	2,75	IR 220×240×50
240	265	60	2	4,6	IR 240×265×60
260	285	60	2	5	IR 260×285×60
280	305	69	2	6,1	IR 280×305×69
300	330	80	2,1	9,2	IR 300×330×80
320	350	80	2,1	9,8	IR 320×350×80
340	370	80	2,1	10	IR 340×370×80
360	390	80	2,1	11	IR 360×390×80
380	415	100	2,1	17	IR 380×415×100

Needle rollers

Needle rollers can be used to make full complement bearing arrangements for slow speed or oscillating applications. These compact bearing arrangements have a high load carrying capacity and are economical, provided the shaft and housing bore can serve as raceways. The cylindrical surface of the rollers is slightly relieved toward the roller ends to prevent damaging edge stresses.

For additional information about surface requirements for raceways, refer to the section *Raceways on shafts and in housings*, starting on **page 50**. For assistance in designing full complement bearing arrangements or to calculate performance data for these bearing arrangements, contact the SKF application engineering service.

Materials

SKF needle rollers are made from carbon chromium steel with a hardness of 58 to 65 HRC and have a precision machined surface.

Tolerances

SKF needle rollers are in accordance with ISO 3096:1996 Grade 2 for flat end needle rollers. SKF supplies needle rollers with the dimensional and form tolerances as listed in **table 3**, where the preferred diameter deviations range from 0 to $-7\ \mu\text{m}$.

The rollers are gauged according to their minimum and maximum deviation from the nominal diameter.

Needle rollers for each gauge are packed separately and the package is marked with the gauge limits, e.g. N/M2 or M2/M4, where M signifies minus and N zero. For a needle roller with a 2 mm nominal diameter and gauge limits M2/M4, the actual diameter is between 1,998 mm and 1,996 mm.

Note

Needle rollers of the same gauge should be used in each bearing arrangement.

A delivery of needle rollers of the same nominal diameter may contain packages of one or more gauges, depending on availability at the time.

Table 3

Dimensional and form accuracy of SKF needle rollers, grade G2

Diameter D_w Deviation		Gauge tolerance	Gauge limits	Roundness (max circularity deviation in accordance with ISO 3096)	Length L_w Tolerance class
high	low				
μm					–
0	-10	2	0/-2 -1/-3 -2/-4 -3/-5 -4/-6 -5/-7 -6/-8 -7/-9 -8/-10	1	h13

Supplementary designations

The designation suffixes used to identify certain features of SKF needle rollers are explained in the following.

- BF** Needle roller with flat ends
- G2** Needle roller in accordance with ISO 3096:1996 Grade 2
- M../M..** Diameter tolerance of needle rollers, e.g. M2/M4 indicates diameter tolerance -2 to $-4 \mu\text{m}$
- N/M..** Diameter tolerance of needle rollers, e.g. N/M2 indicates diameter tolerance 0 to $-2 \mu\text{m}$

Needle rollers

D_w 1 – 6 mm

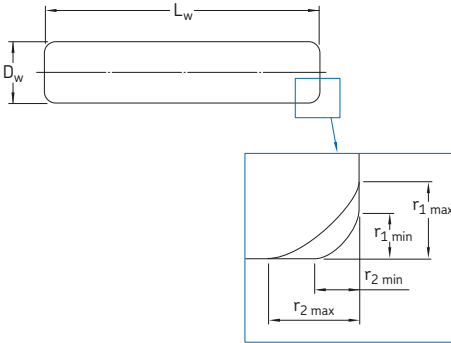

Dimensions					Mass per 1000	Designation
D_w	L_w	$r_{1,2}$ min	r_1 max	r_2 max		
mm					kg	–
1	7,8	0,1	0,4	0,6	0,048	RN-1x7.8 BF/G2
1,5	5,8	0,1	0,4	0,6	0,081	RN-1.5x5.8 BF/G2
	6,8	0,1	0,4	0,6	0,094	RN-1.5x6.8 BF/G2
	7,8	0,1	0,4	0,6	0,108	RN-1.5x7.8 BF/G2
	9,8	0,1	0,4	0,6	0,136	RN-1.5x9.8 BF/G2
	11,8	0,1	0,4	0,6	0,164	RN-1.5x11.8 BF/G2
	13,8	0,1	0,4	0,6	0,191	RN-1.5x13.8 BF/G2
2	6,3	0,2	0,6	0,8	0,16	RN-2x6.3 BF/G2
	7,8	0,2	0,6	0,8	0,19	RN-2x7.8 BF/G2
	9,8	0,2	0,6	0,8	0,24	RN-2x9.8 BF/G2
	11,8	0,2	0,6	0,8	0,29	RN-2x11.8 BF/G2
	13,8	0,2	0,6	0,8	0,34	RN-2x13.8 BF/G2
	15,8	0,2	0,6	0,8	0,39	RN-2x15.8 BF/G2
	17,8	0,2	0,6	0,8	0,44	RN-2x17.8 BF/G2
	19,8	0,2	0,6	0,8	0,49	RN-2x19.8 BF/G2
	21,8	0,2	0,6	0,8	0,54	RN-2x21.8 BF/G2
	2,5	7,8	0,2	0,6	0,8	0,3
9,8		0,2	0,6	0,8	0,38	RN-2.5x9.8 BF/G2
11,8		0,2	0,6	0,8	0,45	RN-2.5x11.8 BF/G2
13,8		0,2	0,6	0,8	0,53	RN-2.5x13.8 BF/G2
15,8		0,2	0,6	0,8	0,61	RN-2.5x15.8 BF/G2
17,8		0,2	0,6	0,8	0,69	RN-2.5x17.8 BF/G2
19,8		0,2	0,6	0,8	0,76	RN-2.5x19.8 BF/G2
21,8		0,2	0,6	0,8	0,84	RN-2.5x21.8 BF/G2
3	9,8	0,2	0,6	0,8	0,54	RN-3x9.8 BF/G2
	11,8	0,2	0,6	0,8	0,65	RN-3x11.8 BF/G2
	13,8	0,2	0,6	0,8	0,77	RN-3x13.8 BF/G2
	15,8	0,2	0,6	0,8	0,88	RN-3x15.8 BF/G2
	17,8	0,2	0,6	0,8	0,99	RN-3x17.8 BF/G2
	19,8	0,2	0,6	0,8	1,1	RN-3x19.8 BF/G2
	21,8	0,2	0,6	0,8	1,21	RN-3x21.8 BF/G2
	23,8	0,2	0,6	0,8	1,32	RN-3x23.8 BF/G2

Dimensions					Mass per 1000	Designation
D _w	L _w	r _{1,2} min	r ₁ max	r ₂ max		
mm					kg	–
3,5	11,8	0,3	0,8	1	0,89	RN-3.5×11.8 BF/G2
	13,8	0,3	0,8	1	1,04	RN-3.5×13.8 BF/G2
	15,8	0,3	0,8	1	1,19	RN-3.5×15.8 BF/G2
	17,8	0,3	0,8	1	1,34	RN-3.5×17.8 BF/G2
	19,8	0,3	0,8	1	1,5	RN-3.5×19.8 BF/G2
	21,8	0,3	0,8	1	1,65	RN-3.5×21.8 BF/G2
	29,8	0,3	0,8	1	2,25	RN-3.5×29.8 BF/G2
	34,8	0,3	0,8	1	2,63	RN-3.5×34.8 BF/G2
	4	11,8	0,3	0,8	1	1,16
13,8		0,3	0,8	1	1,36	RN-4×13.8 BF/G2
15,8		0,3	0,8	1	1,56	RN-4×15.8 BF/G2
17,8		0,3	0,8	1	1,76	RN-4×17.8 BF/G2
19,8		0,3	0,8	1	1,95	RN-4×19.8 BF/G2
21,8		0,3	0,8	1	2,15	RN-4×21.8 BF/G2
23,8		0,3	0,8	1	2,35	RN-4×23.8 BF/G2
25,8		0,3	0,8	1	2,55	RN-4×25.8 BF/G2
27,8		0,3	0,8	1	2,74	RN-4×27.8 BF/G2
29,8		0,3	0,8	1	2,94	RN-4×29.8 BF/G2
34,8		0,3	0,8	1	3,43	RN-4×34.8 BF/G2
39,8		0,3	0,8	1	3,93	RN-4×39.8 BF/G2
5		15,8	0,3	0,8	1	2,44
	19,8	0,3	0,8	1	3,05	RN-5×19.8 BF/G2
	21,8	0,3	0,8	1	3,36	RN-5×21.8 BF/G2
	23,8	0,3	0,8	1	3,67	RN-5×23.8 BF/G2
	25,8	0,3	0,8	1	3,98	RN-5×25.8 BF/G2
	27,8	0,3	0,8	1	4,28	RN-5×27.8 BF/G2
	29,8	0,3	0,8	1	4,59	RN-5×29.8 BF/G2
	34,8	0,3	0,8	1	5,36	RN-5×34.8 BF/G2
	39,8	0,3	0,8	1	6,13	RN-5×39.8 BF/G2
6	17,8	0,3	0,8	1	3,95	RN-6×17.8 BF/G2

Radial shaft seals with a low cross sectional height

It is not always easy to find commercially available radial shaft seals for bearing arrangements that incorporate needle roller bearings because of their very low cross section. As a result, SKF offers a wide assortment of special low cross section radial shaft seals to fit virtually all of these bearing arrangements. These contact seals are designed without garter springs and available in two designs:

- the G design with a single lip
- the SD design with a double lip

G design radial shaft seals

G design radial shaft seals are made of acrylonitrile-butadiene rubber (NBR). The seals for shaft diameters ≥ 8 mm (\rightarrow fig. 5) are reinforced with sheet steel. The rubber outside diameter enhances the seal around the housing bore and reduces the risk of damage to the seal and housing during installation and removal.

To attain an adequate degree of rigidity for seals for shaft diameters ≤ 7 mm (\rightarrow fig. 6), the rubber material is metal cased. These seals are identified by the designation suffix S.

If the seal is to be used primarily for lubricant retention, it should be mounted with the lip facing inward. If the primary purpose of the seal is to exclude contaminants, the lip should face outward, away from the bearing (\rightarrow fig. 7).

For information about the chemical resistance of acrylonitrile-butadiene rubber (NBR), refer to the *SKF Interactive Engineering Catalogue* (section *Chemical resistance*).

SD design radial shaft seals

SD design radial shaft seals (\rightarrow fig. 8) have a primary seal lip and an auxiliary dust lip. The lips are made of polyurethane (AU) and the reinforcement ring is made of polyamide (PA) instead of metal.

The auxiliary lip is the smaller of the two lips and designed with zero lip/shaft interference to avoid additional friction, heat and energy losses.

The primary seal lip, i.e. the larger of the two lips, is a contact seal and should always point toward the medium that is to be sealed. Therefore, if the primary function is protection

Fig. 5

Radial shaft seal



G series ($d_1 \geq 8$ mm)

Fig. 6

Radial shaft seal

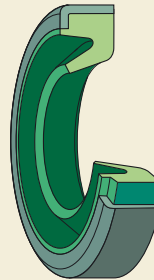

G.. S series ($d_1 \leq 7$ mm)

Fig. 7

Needle roller bearing with machined rings with an external G design seal

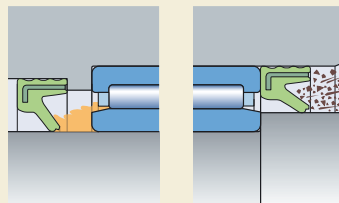

Primary lip facing inward

Primary lip facing outward

against ingress of contaminants, the primary lip should face outward. The auxiliary lip will contribute to retain lubricant in the bearing arrangement.

In applications whereas the main purpose is retaining the lubricant, the primary lip should face inward, toward the bearing.

The cavity between the two lips should be filled with a grease that is compatible with the lubricant used in the application. This will provide additional protection and prevent the seal from dry running.

SD seals are resistant to lubricating oils, even those containing small quantities of EP additives, and also to mineral oil based greases.

Depending on the counterface of the shaft, SD seals can also be used as wiper seals for linear applications with speeds up to 3 m/s.

Design of associated components

Shaft requirements

To achieve a reliable seal and sufficiently long service life, the surface of the seal counterface should have a hardness of at least 55 HRC or 600 HV. The surface roughness of the counterface on the shaft of rotary applications should lie between R_a 0,2 and 0,8 μm , if the maximum permissible circumferential speeds are to be used. For linear applications, the maximum permissible roughness of the counterface is R_a 0,3 μm .

The diameter of the shaft at the counterface should be machined to g7 up to k7 tolerance classes. The shaft end should have a 15 to 30° lead-in chamfer to prevent damage to the seal lips during mounting. Appropriate minimum dimensions for lead-in chamfers (\rightarrow fig. 9) are:

- $h_1 = 0,3$ mm for seals with an outside diameter $d_2 \leq 30$ mm
- $h_1 = 0,5$ mm for seals with an outside diameter $d_2 > 30$ mm

Housing requirements

The housing bore tolerance classes normally recommended for needle roller bearings will provide a sufficient interference fit for the seals.

In general, these seals can be fitted into housing bores machined to G7 up to R7 tolerance class.

Fig. 8

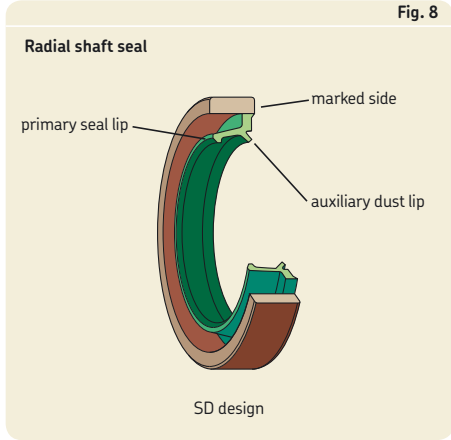
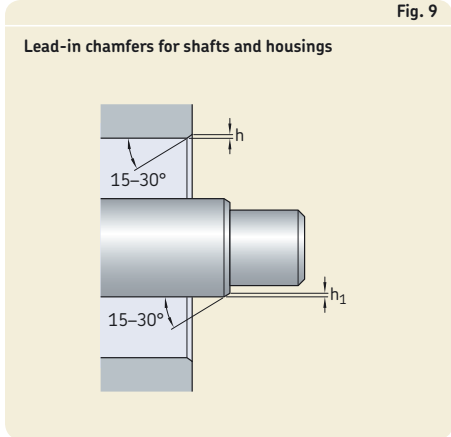

Fig. 9



No additional axial location of the seal will be needed.

To simplify mounting, the housing bore should have a 15 to 30° lead-in chamfer. Appropriate minimum dimensions for lead-in chamfers (\rightarrow fig. 9) are:

- $h = 0,3$ mm for seals with an outside diameter $d_2 \leq 30$ mm
- $h = 0,01 d_2$ mm for seals with an outside diameter $d_2 > 30$ mm

Radial shaft seals with a low cross sectional height

Speeds

If the recommendations under *Design of associated components* are adhered to, the permissible circumferential speed is 10 m/s for both seal designs. To convert circumferential speed to rotational speed, use

$$n = \frac{d \pi 1\,000}{v 60}$$

where

n = rotational speed [r/min]

d = shaft diameter [mm]

v = circumferential speed [m/s]

Operating temperature range

The permissible operating temperature range for

- G design seals is -30 to $+110$ °C
(-20 to $+230$ °F)
- SD design seals is -30 to $+100$ °C
(-20 to $+210$ °F).

These material related temperature ranges can only be considered as rough guidelines as the influence from the medium in which the seal is working must also be considered.

Mounting instructions

The seals should be mounted concentric and perpendicular to the shaft. A suitable mounting tool (→ **fig. 10**) should be used to prevent the seal from skewing. The outside diameter of G design seals should be lightly oiled to ease installation. If the shaft ends are not chamfered or rounded, a mounting sleeve should be used to prevent damage to the seal lip.

Fig. 10

Mounting tool

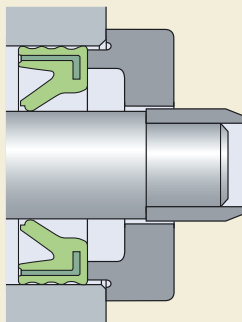

Radial shaft seals with a low cross sectional height
d 4 – 70 mm

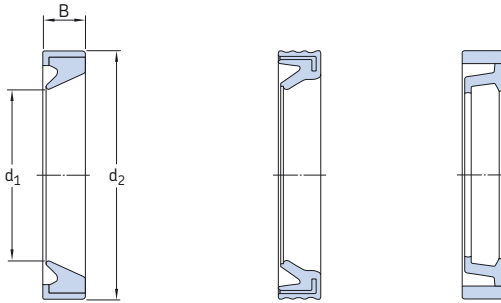

G
($d_1 \leq 7$ mm)

G
($d_1 \geq 8$ mm)

SD

Dimensions			Mass per 100	Designation	Dimensions			Mass per 100	Designation
d_1	d_2	b			d_1	d_2	b		
mm			kg	–	mm			kg	–
4	8	2	0,018	G 4×8×2 S	16	22	3	0,13	G 16×22×3
5	9	2	0,019	G 5×9×2 S		22	3	0,06	SD 16×22×3
	10	2	0,022	G 5×10×2 S		24	3	0,13	G 16×24×3
6	10	2	0,021	G 6×10×2 S		24	3	0,08	SD 16×24×3
	12	2	0,038	G 6×12×2 S		25	3	0,16	G 16×25×3
7	11	2	0,025	G 7×11×2 S	17	23	3	0,13	G 17×23×3
	14	2	0,052	G 7×14×2 S		23	3	0,06	SD 17×23×3
8	12	3	0,041	G 8×12×3		25	3	0,15	G 17×25×3
	15	3	0,065	G 8×15×3		25	3	0,08	SD 17×25×3
	15	3	0,04	SD 8×15×3	18	24	3	0,12	G 18×24×3
9	13	3	0,044	G 9×13×3		24	3	0,06	SD 18×24×3
	16	3	0,069	G 9×16×3		26	4	0,18	G 18×26×4
10	14	3	0,05	G 10×14×3		26	4	0,11	SD 18×26×4
	17	3	0,09	G 10×17×3	19	27	4	0,2	G 19×27×4
	17	3	0,044	SD 10×17×3		27	4	0,11	SD 19×27×4
12	16	3	0,06	G 12×16×3	20	26	4	0,18	G 20×26×4
	18	3	0,09	G 12×18×3		26	4	0,08	SD 20×26×4
	18	3	0,05	SD 12×18×3		28	4	0,21	G 20×28×4
	19	3	0,1	G 12×19×3		28	4	0,11	SD 20×28×4
	19	3	0,06	SD 12×19×3	21	29	4	0,22	G 21×29×4
13	19	3	0,09	G 13×19×3	22	28	4	0,18	G 22×28×4
14	20	3	0,1	G 14×20×3		28	4	0,09	SD 22×28×4
	20	3	0,05	SD 14×20×3		30	4	0,22	G 22×30×4
	21	3	0,11	G 14×21×3		30	4	0,13	SD 22×30×4
	22	3	0,13	G 14×22×3	24	32	4	0,25	G 24×32×4
	22	3	0,07	SD 14×22×3	25	32	4	0,23	G 25×32×4
15	21	3	0,1	G 15×21×3		32	4	0,13	SD 25×32×4
	21	3	0,05	SD 15×21×3		33	4	0,25	G 25×33×4
	23	3	0,13	G 15×23×3		33	4	0,13	SD 25×33×4
	23	3	0,07	SD 15×23×3		35	4	0,26	G 25×35×4
						35	4	0,19	SD 25×35×4

Dimensions			Mass per 100	Designation
d ₁	d ₂	b		
mm			kg	–
26	34	4	0,26	G 26×34×4
	34	4	0,14	SD 26×34×4
28	35	4	0,24	G 28×35×4
	35	4	0,13	SD 28×35×4
	37	4	0,31	G 28×37×4
29	38	4	0,32	G 29×38×4
30	37	4	0,27	G 30×37×4
	37	4	0,13	SD 30×37×4
	40	4	0,36	G 30×40×4
	40	4	0,21	SD 30×40×4
32	42	4	0,37	G 32×42×4
	42	4	0,24	SD 32×42×4
	45	4	0,51	G 32×45×4
35	42	4	0,3	G 35×42×4
	42	4	0,15	SD 35×42×4
	45	4	0,41	G 35×45×4
	45	4	0,25	SD 35×45×4
37	47	4	0,4	G 37×47×4
	47	4	0,27	SD 37×47×4
38	48	4	0,44	G 38×48×4
	48	4	0,28	SD 38×48×4
40	47	4	0,33	G 40×47×4
	47	4	0,17	SD 40×47×4
	50	4	0,46	G 40×50×4
	50	4	0,29	SD 40×50×4
	52	5	0,48	G 40×52×5
	52	5	0,45	SD 40×52×5
42	52	4	0,47	G 42×52×4
	52	4	0,3	SD 42×52×4
43	53	4	0,48	G 43×53×4

Dimensions			Mass per 100	Designation
d ₁	d ₂	b		
mm			kg	–
45	52	4	0,38	G 45×52×4
	52	4	0,19	SD 45×52×4
	55	4	0,52	G 45×55×4
	55	4	0,32	SD 45×55×4
50	58	4	0,45	G 50×58×4
	58	4	0,24	SD 50×58×4
	62	5	1,05	G 50×62×5
	62	5	0,55	SD 50×62×5
55	63	5	0,71	G 55×63×5
70	78	5	0,9	G 70×78×5



Track runner bearings

Support rollers	216
Support rollers without flange rings	216
STO and RSTO design support rollers	217
NA 22...2RS and RNA 22...2RS design support rollers.....	217
Support rollers with flange rings.....	218
NATR design support rollers	218
NATV design support rollers	218
NATR and NATV design support rollers, designation suffix PPA.....	219
NUTR .. A design support rollers.....	219
PWTR ...2RS design support rollers.....	219
NNTR ...2ZL design support rollers	220
Profile of the outer ring running surface.....	220
Dimensions.....	221
Tolerances.....	221
Internal clearance.....	221
Load carrying capacity	221
Cages.....	222
Permissible operating temperature	222
Lubrication.....	222
Design of associated components	223
Mounting instructions.....	223
Supplementary designations.....	224
Product tables.....	226
9.1 Support rollers without flange rings, without an inner ring.....	226
9.2 Support rollers without flange rings, with an inner ring	228
9.3 Support rollers with flange rings, with an inner ring	230
Cam followers	238
KR design cam followers	239
KRE design cam followers	240
KRV design cam followers	240
NUKR design cam followers.....	241
NUKR .. A design cam followers	241
NUKRE .. A design cam followers	241
PWKR design cam followers	242
PWKR ...2RS design cam followers.....	242
PWKRE ...2RS design cam followers	242
Profile of the outer ring running surface.....	243
Accessories	244
Dimensions.....	246
Tolerances.....	247
Internal clearance.....	247
Load carrying capacity	248
Permissible operating temperature	248
Lubrication.....	248
Design of associated components	249
Mounting instructions.....	249
Supplementary designations.....	250
Product tables.....	252
9.4 Cam followers	252

Support rollers

SKF support rollers have an internal design very similar to that of a needle or cylindrical roller bearing. They are characterized by a thick walled outer ring that enables them to accommodate shock loads while reducing distortion and bending stresses. The outer ring running surface is crowned as standard (→ **page 220**). However, support rollers with a cylindrical (flat) running surface are available for certain applications. These pre-greased, ready-to-mount units are suitable for all types of cam drives, tracks and conveyor systems.

SKF support rollers are available:

- without flange rings (→ **fig. 1**)
- with flange rings (→ **fig. 2**)

Support rollers without flange rings

SKF supplies support rollers without flange rings in two designs and variants:

- with or without an inner ring
- open or sealed with two integral flanges in the outer ring

SKF support rollers without flange rings are designed for applications where associated components limit axial movement of the outer ring.

Support rollers with an inner ring have a slightly extended inner ring to enable the necessary axial movement.

Support rollers without an inner ring are intended for arrangements where the pin or shaft can be hardened and ground.

Fig. 1

Support roller without flange rings

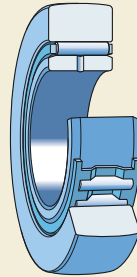
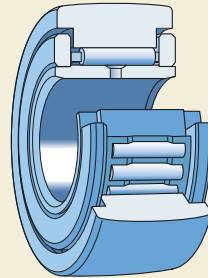

Fig. 2

Support roller with flange rings



STO and RSTO design support rollers

STO design support rollers (→ **fig. 3**) have an inner ring, while RSTO design support rollers (→ **fig. 4**) do not have an inner ring. Both designs are available only as open (without seals) support rollers, making it possible to mount each component separately. However, needle roller and cage assemblies and support roller outer rings must always be kept together as supplied.

NA 22...2RS and RNA 22...2RS design support rollers

NA 22...2RS design support rollers (→ **fig. 5**) have an inner ring that can be mounted individually. RNA 22...2RS design support rollers (→ **fig. 6**) do not have an inner ring and are intended for arrangements where the pin or shaft can be hardened and ground.

The needle roller and cage assembly is axially guided between two integral flanges in the outer ring and forms a non-separable unit with the outer ring.

Both of these designs are fitted with contact seals made of oil and wear-resistant acrylonitrile-butadiene rubber (NBR). They are designed for applications where contamination is light to moderate and where moisture or water spray cannot be avoided.

Fig. 3

STO design support roller

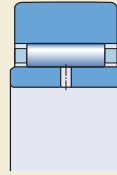

Fig. 4

RSTO design support roller

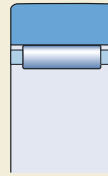

Fig. 5

NA 22...2RS design support roller

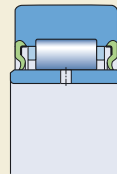
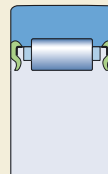

Fig. 6

RNA 22...2RS design support roller



Support rollers

Support rollers with flange rings

Support rollers with flange rings are non-separable units and are available in different designs and variants:

- with gap-type, labyrinth, polyamide or rubber seals
- with needle or cylindrical rollers
- with one or two rows of rollers
- with a cage-guided or a full complement roller set

Support rollers with flange rings are well suited for applications where lateral (thrust) surfaces are not available (→ **fig. 7**). Thrust forces, induced when shafts are not horizontal or when there is misalignment, are accommodated by the flange rings.

NATR design support rollers

NATR design support rollers (→ **fig. 8**) are fitted with a needle roller and cage assembly. The outer ring is guided axially by pressed-on flange rings. The narrow gap between the flange rings and the outer ring serves as a gap-type seal.

NATV design support rollers

NATV design support rollers (→ **fig. 9**) are similar to the NATR design, except that they have a full complement of needle rollers. Therefore, NATV support rollers can accommodate heavier radial loads than NATR support rollers. However, because of the kinematic behaviour of the needle rollers, they are not able to operate at the same high speeds and require more frequent relubrication.

Fig. 7

Application of support roller with flange rings

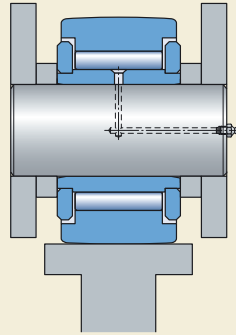

Fig. 8

NATR design support roller

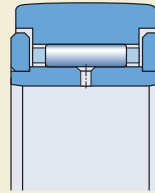
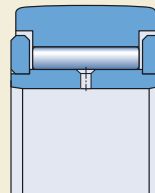

Fig. 9

NATV design support roller



NATR and NATV design support rollers, designation suffix PPA

NATR and NATV design support rollers with the designation suffix PPA have axial sliding rings made of polyamide 66 (→ fig. 10). In the radial direction, the sliding ring forms a narrow labyrinth seal with the outer ring to protect against coarse contaminants. In the axial direction, the sliding ring serves as a contact seal to reliably retain grease in the bearing. This improves the lubrication conditions in the bearing, keeps friction and heat low, and extends grease service life.

NUTR .. A design support rollers

NUTR .. A design support rollers (→ fig. 11) are based on double row full complement cylindrical roller bearings. The outer ring has two integral flanges to axially guide the roller complements. A loose flange ring on both sides of the inner ring provides axial guidance for the outer ring via the roller complements. This enables NUTR .. A design support rollers to accommodate axial loads that occur when operating in a tilted or inclined position and to operate at relatively high speeds.

Sheet metal angle rings that are pressed into the outer ring and extend over the flange rings hold the bearing components together and form effective labyrinth seals.

If heavy shock loads can be expected, support rollers with a reinforced outer ring should be used. These are identified by a four- or five-digit number instead of a two-digit number in the bearing designation, e.g. NUTR 50110 A. If heavy shock loads can be expected, support rollers with a reinforced outer ring should be used. These are identified by a four- or five-digit number instead of a two-digit number in the bearing designation, e.g. NUTR 50110 A.

PWTR ...2RS design support rollers

PWTR ...2RS design support rollers (→ fig. 12) have a contact seal of oil and wear-resistant acrylonitrile-butadiene rubber (NBR) on both sides. The seals make these rollers particularly suitable for operation under arduous conditions. The seals, which are integral with the sheet metal angle rings, press against the flange rings. The angle rings are pressed in the outer ring and extend over the flange rings to hold the components together.

Three integral flanges in the outer ring axially guide the two full complement roller sets sep-

Fig. 10

NATR design support roller, designation suffix PPA

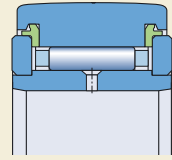

NATR .. PPA series

NATV design support roller, designation suffix PPA

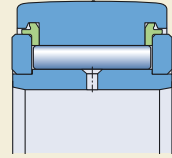

NATV .. PPA series

Fig. 11

NUTR .. A design support roller

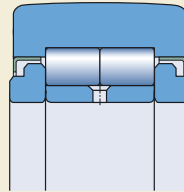
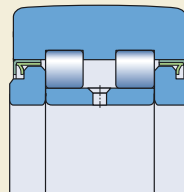

Fig. 12

PWTR ...2RS design support roller



Support rollers

arately, to minimize friction in the support roller, thereby reducing the amount of heat generated by the bearing. A loose flange ring on both sides of the inner ring provides axial guidance for the outer ring via the roller complements. This enables the support rollers to accommodate axial loads that occur when operating in a tilted or inclined position.

The large space between the two rows of rollers enables a large quantity of grease to be incorporated. The large grease fill and efficient sealing method make it possible to operate PWTR ...2RS design support rollers for much longer periods between maintenance intervals than was previously possible, even under contaminated conditions. If heavy shock loads can be expected, SKF recommends to applying support rollers with a reinforced outer ring. These are identified by a four- or five-digit number instead of a two-digit number in the bearing designation, e.g. PWTR 50110.2RS.

NNTR ...2ZL design support rollers

NNTR ...2ZL design support rollers have a full complement of rollers (→ **fig. 13**) and can accommodate very heavy radial loads. NNTR ...2ZL design support rollers incorporate a lamellar seal on both sides. These seals are inserted into recesses in the shoulders of the flange rings and the outer ring and provide support to hold the bearing together. Three integral flanges in the outer ring axially guide the two rows of full complement rollers separately to minimize friction in the support roller, thereby reducing the amount of heat generated by the bearing. Two loose flange rings guide the outer ring axially via the roller complements. This enables the support rollers to accommodate the relatively heavy constant axial loads that occur when support rollers operate in an inclined position.

Profile of the outer ring running surface

Crowned outer ring running surface

SKF supplies support rollers, as standard, with a crowned outer ring running surface. This surface provides good load distribution during operation when the bearing is in a tilted or inclined position.

Fig. 13

NNTR ...2ZL design support roller

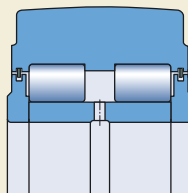

The crowned running surface has a radius of 500 mm for the following support roller designs:

- STO and RSTO designs
- NA 22...2RS and RNA 22...2RS designs
- NATR and NATV without designation suffix

SKF also supplies support rollers with an improved crowned profile of the outer ring running surface. The modified line contact provides even better load distribution than the standard radius. In practice, this modified line contact provides a higher degree of stiffness while reducing wear between the outer ring running surface and the track.

The following support roller designs have an improved crowned profile:

- NATR and NATV designs, designation suffix PPA
- NUTR .. A design
- PWTR ...2RS design

The crowned running surface of NNTR...2ZL design support rollers depends on the outside diameter of the bearing:

- a 10 000 mm radius for an outside diameter ≤ 260 mm
- a 15 000 mm radius for an outside diameter ≥ 290 mm

Cylindrical outer ring running surface

SKF recommends support rollers with a cylindrical (flat) outer ring running surface for applications requiring a high degree of stiffness and when operating in a tilted or inclined position can be avoided. They are identified by the designation suffix X. These support rollers are dimensionally interchangeable with standard profile support rollers. For additional information, contact the SKF application engineering service.

Dimensions

The dimensions of (R)NA 22...2RS design support rollers are in accordance with ISO 15:1998. The dimensions of NATR, NATV, NUTR ..A and PWTR ...2RS design support rollers, where standardized, are in accordance with ISO 7063:2003 and ANSI/ABMA Standard 18.1-1982.

Tolerances

SKF supplies support rollers to Normal tolerances in accordance with ISO 492:2002. Exceptions are:

- the tolerance for the outside diameter D of the running surface with a crowned profile, 0/-0,050 mm
- the tolerance for the outside diameter D of the running surface of the NNTR ...2ZL design support rollers, h10 tolerance class
- the tolerance for the width B of NNTR design support rollers, 0/-0,50 mm
- the tolerance for the width B of NATR, NATV, NUTR ..A and PWTR ...2RS design support rollers , h12 tolerance class
- the tolerance for the circularity of the inner rings of NATR and NATV design support rollers

The inside diameter F_w of the roller sets for RSTO and RNA 22...2RS design support rollers lies within the limits of F6 tolerance class.

The limits for h10, h12 and F6 tolerance classes are listed in **table 1**.

Table 1

ISO tolerance classes

Nominal dimension over incl.		h10 Deviations high low		h12 Deviations high low		F6 Deviations high low	
mm		µm		µm		µm	
3	6	0	-48	0	-120	+18	+10
6	10	0	-58	0	-150	+22	+13
10	18	0	-70	0	-180	+27	+16
18	30	0	-84	0	-210	+33	+20
30	50	0	-100	0	-250	+41	+25
50	80	0	-120	0	-300	+49	+30
80	120	0	-140	0	-350	+58	+36
120	180	0	-160	0	-400	+68	+43
180	250	0	-185	0	-460	+79	+50
250	315	0	-210	0	-520	+88	+56

Internal clearance

SKF supplies support rollers with a C2 radial internal clearance as standard. However, STO and NA 22...2RS design support rollers without a flange ring have Normal radial internal clearance.

The clearance values are listed in **table 7** on **page 42** and are in accordance with ISO 5753:1991. They are valid for unmounted support rollers under zero measuring load.

Load carrying capacity

Compared to a typical rolling bearing, where the outer ring is fully supported in a housing, a support roller has only a small contact area between its outside diameter and the track. The actual contact area depends on the applied radial load and whether the running surface is crowned or cylindrical (flat). The deformation of the outer ring, caused by this limited contact, alters the force distribution in the bearing, which affects load carrying capacity. The basic load ratings listed in the product tables take this into account.

The ability to accommodate dynamic loads depends on the requisite life, but it is also important to consider the strength of the outer

Support rollers

ring. Therefore, the value of the maximum dynamic radial load F_r should not be exceeded.

The permissible static load for a support roller is determined by the smaller of the values F_{0r} and C_0 . If requirements for smooth running are below normal, the static load may exceed C_0 , but should never exceed the maximum permissible static radial load F_{0r} .

Cages

(R)STO, (R)NA 22...2RS and NATR design support rollers are fitted with a steel cage (→ **fig. 14**), except for (R)STO design support rollers with the designation suffix TN. These support rollers have a cage made of glass fibre reinforced polyamide 66 (→ **fig. 15**) that can operate at temperatures up to 120 °C.

For additional information about the temperature resistance and the applicability of cages, refer to the section *Cage materials*, starting on **page 44**.

Permissible operating temperature

Generally, the permissible temperature range for support rollers is -30 to +140 °C.

Exceptions due to the seal and cage material are:

- -30 to +120 °C for (R)NA 22...2RS and PWTR ...2RS designs and the (R)STO design, designation suffix TN
- -30 to +100 °C for NATR and NATV designs, designation suffix PPA

Exceptions due to the applied grease must also be taken into account.

For additional information about temperature restrictions, refer to the sections *Cage materials* (→ **page 44**) and *Lubrication* (→ **page 52**).

Lubrication

All support rollers are filled at the factory with a high-quality grease with good corrosion inhibiting properties.

Although SKF support rollers require little maintenance, they must be relubricated to achieve their full service life. SKF recommends relubrication while the initial grease fill still has its full lubricating properties. A lubrication hole is provided in the inner ring so that if suitable ducts are provided in the pin, the support rollers are easy to relubricate. Support rollers used in applications where there are light loads, relatively low speeds and clean surroundings, can operate for long periods before relubrication is required. Support rollers that operate under contaminated and damp conditions at high speeds or at temperatures above +70 °C require frequent relubrication. Full complement NATV and NUTR ..A design support rollers require more frequent relubrication. SKF recommends using SKF LGWA 2 grease for relubrication.

For additional information about greases, refer to the section *Lubrication*, starting on **page 52**.

Fig. 14

Machined steel cage

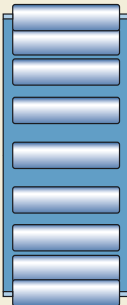
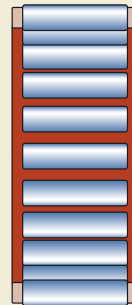

Fig. 15

Polyamide 66 cage



SKF supplies all inner rings for support rollers with one lubrication hole except for inner rings of the NNTR design, which have:

- 3 lubrication holes for a bore diameter ≤ 90 mm
- 6 lubrication holes for a bore diameter ≥ 100 mm

(R)STO design support rollers can be oil or grease lubricated. In applications where oil is used, SKF recommends thoroughly washing the initial grease fill from the bearing prior to operation.

Design of associated components

Axial play

Support rollers with inner rings and flange rings, if included, must be located without axial play (\rightarrow fig. 16).

Support rollers without an inner ring must have an axial play of 0,2 mm to the support surfaces (\rightarrow fig. 16).

Support surfaces

The outer ring support surfaces of support rollers without flange rings must be fine turned, free of burrs and clean. Unhardened surfaces should extend to at least half the outer ring side face (\rightarrow fig. 16) while hardened surfaces may be smaller.

Heavily loaded support rollers with flange rings should be provided with complete support for the flange ring side faces and the support surface should be dimensioned according to the diameter d_1 (\rightarrow fig. 17).

Pins

Support rollers generally operate under conditions of stationary inner ring load. For this type of load, and if easy displacement of the inner ring is required, the pins should be machined to a g6 tolerance class. The appropriate tolerance for pins for support rollers without an inner ring is a k5 tolerance class. To exploit the full load carrying capacity of the support roller, the raceways on the pins should have the same hardness and surface finish normally found on bearing raceways. For detailed information, refer to the section *Raceways on shafts and in housings*, starting on **page 50**.

Fig. 16

Support roller without flange rings, axial guidance provided by associated components

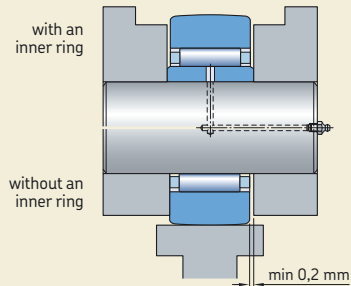
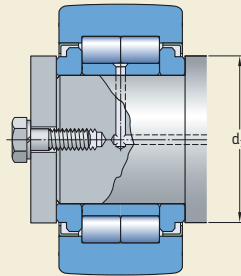

Fig. 17

Support roller with integral flanges in the outer ring, axial guidance provided by loose flange rings



Support rollers

Mounting instructions

SKF recommends positioning the lubrication hole in the unloaded zone of the support roller inner ring.

When mounting the outer ring assembly and inner ring individually, care must be taken not to damage the lips of the seals.

Supplementary designations

The designation suffixes used to identify certain features of SKF support rollers are explained in the following.

- .2RS** Contact seal of acrylonitrile-butadiene rubber (NBR) on both sides of the support roller
- .2ZL** Support rollers with a lamellar seal on both sides
- A** NUTR design support rollers with an improved crowned profile of the outer ring running surface
- PPA** NATR or NATV design support rollers with a polyamide 66 axial sliding and sealing ring on both sides. Improved crowned profile of the outer ring running surface.
- TN** Injection moulded cage of glass fibre reinforced polyamide 66
- X** Cylindrical (flat) profile of the outer ring running surface

Support rollers without flange rings, without an inner ring
D 16 – 90 mm

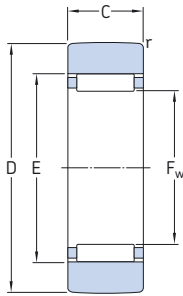

RSTO

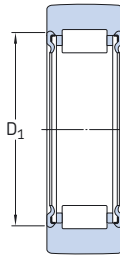

RNA 22...2RS

Dimensions						Limiting speed	Mass	Designation
D	C	D ₁	F _w	E	r			
mm						r/min	kg	–
16	7,8	–	7	10	0,3	8 000	0,0085	RSTO 5 TN
19	9,8 11,8	– 16	10 10	13 –	0,3 0,3	7 000 7 000	0,013 0,018	RSTO 6 TN RNA 22/6.2RS
24	9,8 11,8	– 18	12 12	15 –	0,3 0,3	7 000 6 700	0,021 0,029	RSTO 8 TN RNA 22/8.2RS
30	11,8 13,8	– 20	14 14	20 –	0,3 0,6	6 000 6 300	0,042 0,052	RSTO 10 RNA 2200.2RS
32	11,8 13,8	– 22	16 16	22 –	0,3 0,6	5 600 6 000	0,049 0,057	RSTO 12 RNA 2201.2RS
35	11,8 13,8	– 26	20 20	26 –	0,3 0,6	5 000 5 000	0,050 0,060	RSTO 15 RNA 2202.2RS
40	15,8 15,8	28 –	22 22	– 29	1 0,3	4 500 4 500	0,094 0,088	RNA 2203.2RS RSTO 17
47	15,8 17,8	– 33	25 25	32 –	0,3 1	4 000 4 000	0,13 0,15	RSTO 20 RNA 2204.2RS
52	15,8 17,8	– 38	30 30	37 –	0,3 1	3 400 3 400	0,15 0,18	RSTO 25 RNA 2205.2RS
62	19,8 19,8	43 –	35 38	– 46	1 0,6	2 800 2 600	0,28 0,26	RNA 2206.2RS RSTO 30
72	19,8 22,7	– 50	42 42	50 –	0,6 1,1	2 200 2 200	0,38 0,43	RSTO 35 RNA 2207.2RS
80	19,8 22,7	– 57	50 48	58 –	1 1,1	1 900 1 900	0,42 0,53	RSTO 40 RNA 2208.2RS
85	19,8	–	55	63	1	1 700	0,45	RSTO 45
90	19,8	–	60	68	1	1 600	0,48	RSTO 50

Designation	Basic load ratings		Fatigue load limit	Maximum radial forces	
	dynamic	static		dynamic	static
	C	C ₀	P _u	F _r	F _{0r}
–	kN		kN	kN	
RSTO 5 TN	2,51	2,5	0,27	3,55	5
RSTO 6 TN	3,74	4,5	0,5	4,25	6,1
RNA 22/6.2RS	3,52	3	0,34	1,93	2,75
RSTO 8 TN	4,13	5,4	0,6	7,5	10,8
RNA 22/8.2RS	4,46	4,4	0,5	5	7,1
RSTO 10	8,25	8,8	1,04	8,5	12,2
RNA 2200.2RS	6,44	7,2	0,85	12	17
RSTO 12	8,8	9,8	1,18	8,3	12
RNA 2201.2RS	6,93	8,15	0,965	11,6	16,6
RSTO 15	9,13	10,6	1,27	7,1	10
RNA 2202.2RS	7,21	9	1,04	9,65	13,7
RNA 2203.2RS	9,35	12,9	1,53	16	22,8
RSTO 17	14,2	17,6	2,08	12	17,3
RSTO 20	16,1	21,2	2,5	18,6	26,5
RNA 2204.2RS	15,4	17,3	2,12	17,6	25,5
RSTO 25	16,5	22,8	2,7	18	26
RNA 2205.2RS	16,1	19	2,32	17,3	24,5
RNA 2206.2RS	17,6	24,5	3	28,5	40,5
RSTO 30	22,9	34,5	4,25	23,6	33,5
RSTO 35	24,6	39	4,8	36	51
RNA 2207.2RS	22	34	4,3	39	56
RSTO 40	23,8	39	4,75	34,5	49
RNA 2208.2RS	27	39	4,9	37,5	53
RSTO 45	25,1	43	5,3	34,5	50
RSTO 50	26	45,5	5,7	34,5	50

Support rollers without flange rings, with an inner ring
D 19 – 90 mm

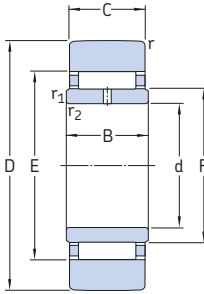

STO

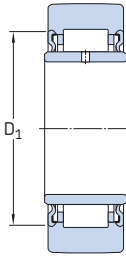

NA 22...2RS

Dimensions									Limiting speed	Mass	Designation
D	d	C	B	D ₁	F	E	r _{min}	r _{1,2 min}			
mm									r/min	kg	–
19	6	9,8	10	–	10	13	0,3	0,3	7 000	0,017	STO 6 TN NA 22/6.2RS
	6	11,8	12	16	10	–	0,3	0,3	7 000	0,022	
24	8	9,8	10	–	12	15	0,3	0,3	7 000	0,026	STO 8 TN NA 22/8.2RS
	8	11,8	12	18	12	–	0,3	0,3	6 700	0,034	
30	10	11,8	12	–	14	20	0,3	0,3	6 000	0,049	STO 10 NA 2200.2RS
	10	13,8	14	20	14	–	0,6	0,3	6 300	0,06	
32	12	11,8	12	–	16	22	0,3	0,3	5 600	0,057	STO 12 NA 2201.2RS
	12	13,8	14	22	16	–	0,6	0,3	6 000	0,067	
35	15	11,8	12	–	20	26	0,3	0,3	5 000	0,063	STO 15 NA 2202.2RS
	15	13,8	14	26	20	–	0,6	0,3	5 000	0,075	
40	17	15,8	16	–	22	29	0,3	0,3	4 500	0,11	STO 17 NA 2203.2RS
	17	15,8	16	28	22	–	1	0,3	4 500	0,11	
47	20	15,8	16	–	25	32	0,3	0,3	4 000	0,15	STO 20 NA 2204.2RS
	20	17,8	18	33	25	–	1	0,3	4 000	0,18	
52	25	15,8	16	–	30	37	0,3	0,3	3 400	0,18	STO 25 NA 2205.2RS
	25	17,8	18	38	30	–	1	0,3	3 400	0,21	
62	30	19,8	20	–	38	46	0,6	0,6	2 800	0,31	STO 30 NA 2206.2RS
	30	19,8	20	43	35	–	1	0,3	2 600	0,32	
72	35	19,8	20	–	42	50	0,6	0,6	2 200	0,44	STO 35 NA 2207.2RS
	35	22,7	23	50	42	–	1,1	0,6	2 200	0,51	
80	40	19,8	20	–	50	58	1	1	1 900	0,53	STO 40 NA 2208.2RS
	40	22,7	23	57	48	–	1,1	0,6	1 900	0,63	
85	45	19,8	20	–	55	63	1	1	1 700	0,58	STO 45
90	50	19,8	20	–	60	68	1	1	1 600	0,62	STO 50 NA 2210.2RS
	50	22,7	23	68	–	–	1,1	0,6	1 600	0,69	

Designation	Basic load ratings		Fatigue load limit	Maximum radial forces	
	dynamic	static		dynamic	static
	C	C ₀	P _u	F _r	F _{0r}
–	kN		kN	kN	
STO 6 TN	3,74	4,5	0,5	4,25	6,1
NA 22/6.2RS	3,52	3	0,34	1,93	2,75
STO 8 TN	4,13	5,4	0,6	7,5	10,8
NA 22/8.2RS	4,46	4,4	0,5	5	7,1
STO 10	8,25	8,8	1,04	8,5	12,2
NA 2200.2RS	6,44	7,2	0,85	12	17
STO 12	8,8	9,8	1,18	8,3	12
NA 2201.2RS	6,93	8,15	0,965	11,6	16,6
STO 15	9,13	10,6	1,27	7,1	10
NA 2202.2RS	7,21	9	1,04	9,65	13,7
STO 17	14,2	17,6	2,08	12	17,3
NA 2203.2RS	9,35	12,9	1,53	16	22,8
STO 20	16,1	21,2	2,5	18,6	26,5
NA 2204.2RS	15,4	17,3	2,12	17,6	25,5
STO 25	16,5	22,8	2,7	18	26
NA 2205.2RS	16,1	19	2,32	17,3	24,5
STO 30	22,9	34,5	4,25	23,6	33,5
NA 2206.2RS	17,6	24,5	3	28,5	40,5
STO 35	25,5	40,5	5	36	51
NA 2207.2RS	22	34	4,3	39	56
STO 40	23,8	39	4,75	34,5	49
NA 2208.2RS	27	39	4,9	37,5	53
STO 45	25,1	43	5,3	34,5	50
STO 50	26	45,5	5,7	34,5	50
NA 2210.2RS	27	41,5	5,2	36,5	52

Support rollers with flange rings, with an inner ring
D 16 – 40 mm

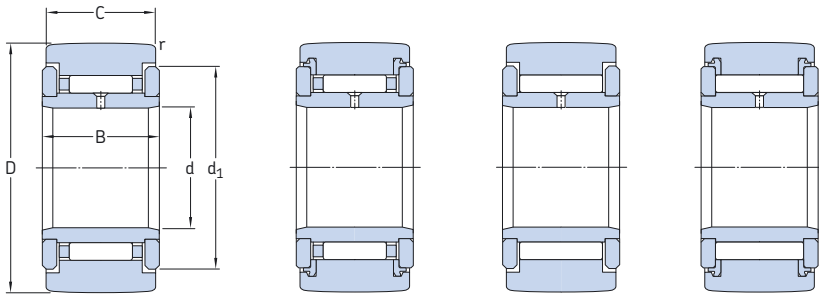

NATR

NATR .. PPA

NATV

NATV .. PPA

Dimensions						Limiting speed	Mass	Designation	
D	d	C	B	d ₁	r	r _{1,2}			
mm					min	min	r/min	kg	
16	5	11	12	12	0,15	–	6 000	0,014	NATR 5
	5	11	12	12	0,15	–	6 000	0,014	NATR 5 PPA
	5	11	12	12	0,15	–	4 300	0,015	NATV 5
	5	11	12	12	0,15	–	4 300	0,015	NATV 5 PPA
19	6	11	12	14	0,15	–	5 600	0,02	NATR 6
	6	11	12	14	0,15	–	5 600	0,02	NATR 6 PPA
	6	11	12	14	0,15	–	4 000	0,021	NATV 6
	6	11	12	14	0,15	–	4 000	0,021	NATV 6 PPA
24	8	14	15	19	0,3	–	5 000	0,041	NATR 8
	8	14	15	19	0,3	–	5 000	0,041	NATR 8 PPA
	8	14	15	19	0,3	–	3 600	0,042	NATV 8
	8	14	15	19	0,3	–	3 600	0,042	NATV 8 PPA
30	10	14	15	23	0,6	–	4 800	0,064	NATR 10
	10	14	15	23	0,6	–	4 800	0,064	NATR 10 PPA
	10	14	15	23	0,6	–	3 200	0,065	NATV 10
	10	14	15	23	0,6	–	3 200	0,065	NATV 10 PPA
32	12	14	15	25	0,6	–	4 500	0,071	NATR 12
	12	14	15	25	0,6	–	4 500	0,071	NATR 12 PPA
	12	14	15	25	0,6	–	3 000	0,072	NATV 12
	12	14	15	25	0,6	–	3 000	0,072	NATV 12 PPA
35	15	18	19	27	0,6	–	4 000	0,1	NATR 15
	15	18	19	27	0,6	–	4 000	0,1	NATR 15 PPA
	15	18	19	27	0,6	–	2 600	0,11	NATV 15
	15	18	19	27	0,6	–	2 600	0,11	NATV 15 PPA
	15	18	19	20	0,6	0,6	5 000	0,1	NUTR 15 A
	15	18	19	20	0,6	0,6	5 000	0,1	PWTR 15.2RS
40	17	20	21	32	1	–	3 400	0,14	NATR 17
	17	20	21	32	1	–	3 400	0,14	NATR 17 PPA
	17	20	21	32	1	–	2 200	0,15	NATV 17
	17	20	21	32	1	–	2 200	0,15	NATV 17 PPA
	17	20	21	22	1	0,5	4 500	0,15	NUTR 17 A
	17	20	21	22	1	0,5	4 500	0,15	PWTR 17.2RS

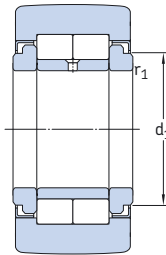

NUTR...A

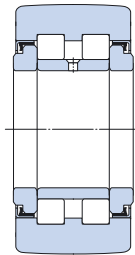

PWTR...2RS

Designation	Basic load ratings		Fatigue load limit	Maximum radial forces	
	dynamic	static		dynamic	static
	C	C ₀	P _u	F _r	F _{0r}
	kN		kN	kN	
NATR 5	3,14	3,2	0,345	2,9	4,15
NATR 5 PPA	3,14	3,2	0,345	2,9	4,15
NATV 5	4,73	6,55	0,72	4,05	5,7
NATV 5 PPA	4,73	6,55	0,72	4,05	5,7
NATR 6	3,47	3,8	0,415	3,8	5,5
NATR 6 PPA	3,47	3,8	0,415	3,8	5,5
NATV 6	5,28	8	0,88	5,1	7,35
NATV 6 PPA	5,28	8	0,88	5,1	7,35
NATR 8	5,28	6,1	0,695	5,2	7,35
NATR 8 PPA	5,28	6,1	0,695	5,2	7,35
NATV 8	7,48	11,4	1,32	7,35	10,4
NATV 8 PPA	7,48	11,4	1,32	7,35	10,4
NATR 10	6,44	8	0,88	7,8	11,2
NATR 10 PPA	6,44	8	0,88	7,8	11,2
NATV 10	8,97	14,6	1,66	11	15,6
NATV 10 PPA	8,97	14,6	1,66	11	15,6
NATR 12	6,6	8,5	0,95	7,65	10,8
NATR 12 PPA	6,6	8,5	0,95	7,65	10,8
NATV 12	9,35	15,3	1,76	10,6	15
NATV 12 PPA	9,35	15,3	1,76	10,6	15
NATR 15	9,52	13,7	1,56	11,4	16,3
NATR 15 PPA	9,52	13,7	1,56	11,4	16,3
NATV 15	12,3	23,2	2,7	14,6	20,8
NATV 15 PPA	12,3	23,2	2,7	14,6	20,8
NUTR 15 A	16,8	17,6	2	8,65	12,2
PWTR 15.2RS	11,9	11,4	1,2	8,65	12,5
NATR 17	10,5	14,6	1,73	12,5	18
NATR 17 PPA	10,5	14,6	1,73	12,5	18
NATV 17	14,2	26,5	3,1	17	24,5
NATV 17 PPA	14,2	26,5	3,1	17	24,5
NUTR 17 A	19	22	2,5	14	20
PWTR 17.2RS	13,8	14,3	1,5	13,7	19,6

Support rollers with flange rings, with an inner ring
D 42 – 72 mm

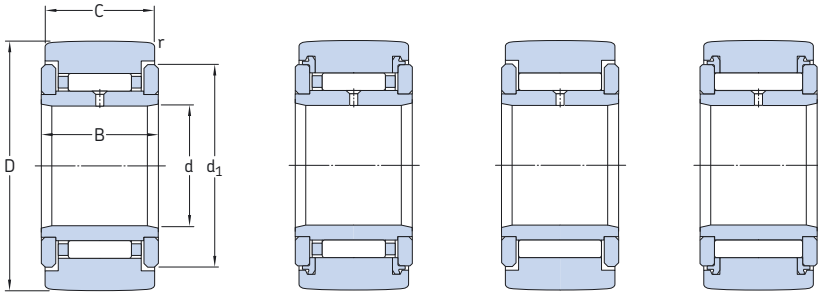

NATR

NATR .. PPA

NATV

NATV .. PPA

Dimensions							Limiting speed	Mass	Designation
D	d	C	B	d ₁	r _{min}	r _{1,2 min}			
mm							r/min	kg	–
42	15	18	19	20	0,6	0,3	5 000	0,16	NUTR 1542 A
	15	18	19	20	0,6	0,3	5 000	0,16	PWTR 1542.2RS
47	17	20	21	22	1	0,5	4 500	0,22	NUTR 1747 A
	17	20	21	22	1	0,5	4 500	0,22	PWTR 1747.2RS
	20	24	25	37	1	–	3 000	0,25	NATR 20
	20	24	25	37	1	–	3 000	0,25	NATR 20 PPA
	20	24	25	37	1	–	1 900	0,25	NATV 20
	20	24	25	37	1	–	1 900	0,25	NATV 20 PPA
	20	24	25	27	1	0,5	3 800	0,25	NUTR 20 A
	20	24	25	27	1	0,5	3 800	0,25	PWTR 20.2RS
52	20	24	25	27	1	0,5	3 800	0,32	NUTR 2052 A
	20	24	25	27	1	0,5	3 800	0,32	PWTR 2052.2RS
	25	24	25	42	1	–	2 400	0,28	NATR 25
	25	24	25	42	1	–	2 400	0,28	NATR 25 PPA
	25	24	25	42	1	–	1 600	0,29	NATV 25
	25	24	25	42	1	–	1 600	0,29	NATV 25 PPA
	25	24	25	31	1	0,5	3 200	0,28	NUTR 25 A
	25	24	25	31	1	0,5	3 200	0,28	PWTR 25.2RS
62	25	24	25	31	1	0,5	3 200	0,45	NUTR 2562 A
	25	24	25	31	1	0,5	3 200	0,45	PWTR 2562.2RS
	30	28	29	51	1	–	1 800	0,47	NATR 30
	30	28	29	51	1	–	1 800	0,47	NATR 30 PPA
	30	28	29	51	1	–	1 400	0,48	NATV 30
	30	28	29	51	1	–	1 400	0,48	NATV 30 PPA
	30	28	29	38	1	0,5	2 600	0,47	NUTR 30 A
	30	28	29	38	1	0,5	2 600	0,47	PWTR 30.2RS
72	30	28	29	38	1	0,5	2 600	0,7	NUTR 3072 A
	30	28	29	38	1	0,5	2 000	0,7	PWTR 3072.2RS
	35	28	29	58	1,1	–	1 600	0,64	NATR 35 PPA
	35	28	29	58	1,1	–	1 100	0,65	NATV 35 PPA
	35	28	29	44	1,1	0,6	2 000	0,63	NUTR 35 A
	35	28	29	44	1,1	0,6	2 000	0,63	PWTR 35.2RS

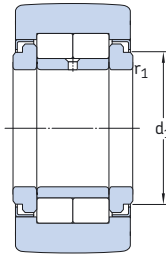

NUTR...A

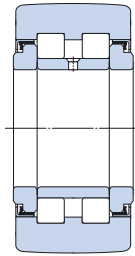

PWTR...2RS

Designation	Basic load ratings		Fatigue load limit	Maximum radial forces	
	dynamic C	static C ₀		dynamic F _r	static F _{0r}
–	kN		kN	kN	
NUTR 1542 A	20,1	23,2	2,65	21,6	31
PWTR 1542.2RS	14,2	15	1,6	22	31,5
NUTR 1747 A	22	27	3,05	30	43
PWTR 1747.2RS	15,7	17,6	1,86	30	42,5
NATR 20	14,7	24,5	2,9	23,6	33,5
NATR 20 PPA	14,7	24,5	2,9	23,6	33,5
NATV 20	19,4	41,5	5	30,5	43
NATV 20 PPA	19,4	41,5	5	30,5	43
NUTR 20 A	28,6	33,5	3,9	17,6	25
PWTR 20.2RS	22,9	24,5	2,8	18,3	26
NUTR 2052 A	31,9	39	4,55	30	42,5
PWTR 2052.2RS	25,5	29	3,35	30,5	44
NATR 25	14,7	25,5	3,1	21,6	31
NATR 25 PPA	14,7	25,5	3,1	21,6	31
NATV 25	19,8	44	5,3	28,5	40,5
NATV 25 PPA	19,8	44	5,3	28,5	40,5
NUTR 25 A	29,7	36	4,25	18	25,5
PWTR 25.2RS	23,8	26,5	3,05	18,6	26,5
NUTR 2562 A	35,8	48	5,6	44	63
PWTR 2562.2RS	29,2	36	4,05	45	64
NATR 30	22,9	37,5	4,55	26,5	38
NATR 30 PPA	22,9	37,5	4,55	26,5	38
NATV 30	29,2	62	7,65	34,5	49
NATV 30 PPA	29,2	62	7,65	34,5	49
NUTR 30 A	41,3	47,5	5,85	24	34,5
PWTR 30.2RS	31,9	32,5	4,05	20,4	29
NUTR 3072 A	48,4	61	7,5	53	76,5
PWTR 3072.2RS	39,6	45	5,6	47,5	68
NATR 35 PPA	24,6	43	5,3	33,5	48
NATV 35 PPA	31,9	72	8,8	43	62
NUTR 35 A	45,7	57	6,95	33,5	47,5
PWTR 35.2RS	35,8	40,5	5	28	40

Support rollers with flange rings, with an inner ring
D 80 – 240 mm

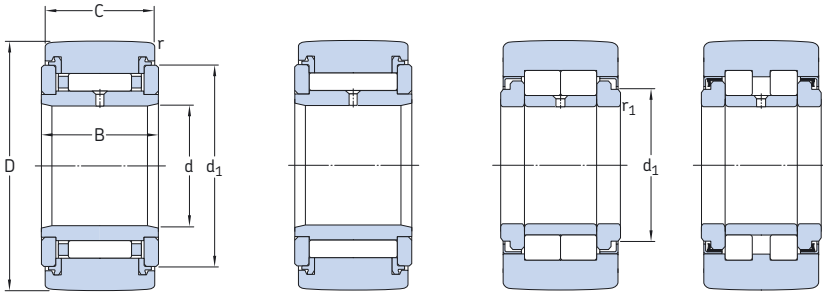

NATR .. PPA

NATV .. PPA

NUTR .. A

PWTR ...2RS

Dimensions							Limiting speed	Mass	Designation
D	d	C	B	d ₁	r _{min}	r _{1,2 min}	r/min	kg	–
mm									
80	35	28	29	44	1,1	0,6	2 000	0,84	NUTR 3580 A
	35	28	29	44	1,1	0,6	2 000	0,84	PWTR 3580.2RS
	40	30	32	66	1,1	–	1 500	0,81	NATR 40 PPA
	40	30	32	66	1,1	–	950	0,89	NATV 40 PPA
	40	30	32	51	1,1	0,6	1 800	0,82	NUTR 40 A
	40	30	32	51	1,1	0,6	1 800	0,82	PWTR 40.2RS
85	45	30	32	55	1,1	0,6	1 700	0,88	NUTR 45 A
	45	30	32	55	1,1	0,6	1 700	0,88	PWTR 45.2RS
90	40	30	32	51	1,1	0,6	1 800	1,13	NUTR 4090 A
	40	30	32	51	1,1	0,6	1 800	1,13	PWTR 4090.2RS
	50	30	32	76	1,1	–	1 200	0,96	NATR 50 PPA
	50	30	32	76	1,1	–	850	0,99	NATV 50 PPA
	50	30	32	60	1,1	0,6	1 600	0,95	NUTR 50 A
	50	30	32	60	1,1	0,6	1 600	0,95	PWTR 50.2RS
100	45	30	32	55	1,1	0,6	1 700	1,4	NUTR 45100 A
	45	30	32	55	1,1	0,6	1 700	1,4	PWTR 45100.2RS
110	50	30	32	60	1,1	0,6	1 600	1,7	NUTR 50110 A
	50	30	32	60	1,1	0,6	1 600	1,7	PWTR 50110.2RS
130	50	63	65	63	3	2	750	5,2	NNTR 50x130x65.2ZL
140	55	68	70	73	3	2	700	6,4	NNTR 55x140x70.2ZL
150	60	73	75	78	3	2	670	7,8	NNTR 60x150x75.2ZL
160	65	73	75	82	3	2	600	8,8	NNTR 65x160x75.2ZL
180	70	83	85	92	3	2	560	13	NNTR 70x180x85.2ZL
200	80	88	90	102	4	2	500	17	NNTR 80x200x90.2ZL
220	90	98	100	119	4	2,5	430	22,5	NNTR 90x220x100.2ZL
240	100	103	105	132	4	2,5	380	28	NNTR 100x240x105.2ZL

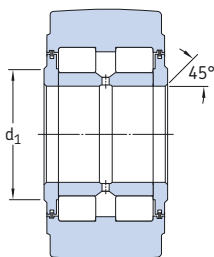

NNTR ...2ZL

Designation	Basic load ratings		Fatigue load limit	Maximum radial forces	
	dynamic	static		dynamic	static
	C	C ₀	P _u	F _r	F _{0r}
	kN		kN	kN	
NUTR 3580 A	51,2	68	8,3	57	81,5
PWTR 3580.2RS	41,8	50	6,3	51	72
NATR 40 PPA	31,9	57	7,1	41,5	58,5
NATV 40 PPA	39,1	88	11	51	73,5
NUTR 40 A	57,2	72	9	32	45,5
PWTR 40.2RS	41,8	49	6	33,5	48
NUTR 45 A	58,3	75	9,3	32,5	46,5
PWTR 45.2RS	42,9	50	6,2	34	48
NUTR 4090 A	68,2	91,5	11,4	63	90
PWTR 4090.2RS	49,5	62	7,65	64	91,5
NATR 50 PPA	30,8	58,5	7,2	40	57
NATV 50 PPA	39,1	93	11,6	50	72
NUTR 50 A	58,3	78	9,65	32,5	47,5
PWTR 50.2RS	42,9	52	6,55	34,5	49
NUTR 45100 A	73,7	104	12,7	80	114
PWTR 45100.2RS	53,9	69,5	8,65	81,5	116
NUTR 50110 A	78,1	116	14,3	98	140
PWTR 50110.2RS	57,2	78	9,65	100	143
NNTR 50x130x65.2ZL	179	232	31	224	320
NNTR 55x140x70.2ZL	209	275	37,5	224	320
NNTR 60x150x75.2ZL	238	320	42,5	265	375
NNTR 65x160x75.2ZL	255	345	46,5	285	405
NNTR 70x180x85.2ZL	330	455	61	375	540
NNTR 80x200x90.2ZL	391	540	71	455	640
NNTR 90x220x100.2ZL	468	670	83	480	680
NNTR 100x240x105.2ZL	528	780	93	550	780

Support rollers with flange rings, with an inner ring
D 260 – 310 mm

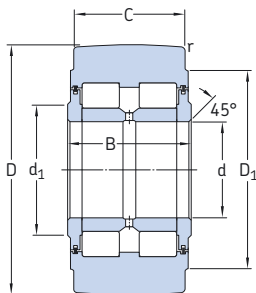

NNTR ...2ZL

Dimensions							Limiting speed	Mass	Designation
D	d	C	B	d ₁	r _{min}	r _{1,2 min}			
mm							r/min	kg	–
260	110	113	115	143	4	2,5	360	35,5	NNTR 110x260x115.2ZL
290	120	133	135	155	4	3	320	53	NNTR 120x290x135.2ZL
310	130	144	146	165	5	3	300	65	NNTR 130x310x146.2ZL

Designation	Basic load ratings		Fatigue load limit	Maximum radial forces	
	dynamic	static		dynamic	static
	C	C ₀	P _u	F _r	F _{0r}
–	kN		kN	kN	
NNTR 110x260x115.2ZL	627	930	112	655	950
NNTR 120x290x135.2ZL	825	1270	143	900	1290
NNTR 130x310x146.2ZL	952	1460	166	1040	1500

Cam followers

SKF cam followers have an internal design very similar to that of a needle or cylindrical roller bearing. They are characterized by a thick-walled outer ring that enables them to accommodate shock loads while reducing distortion and bending stresses. The outer ring running surface is crowned as standard (→ **page 243**). However, cam followers with cylindrical (flat) running surfaces are available for certain applications.

Instead of an inner ring, cam followers have a solid stud (pin) that is threaded so that the cam follower can be quickly and easily attached to appropriate machine components by means of a hexagonal nut.

Axial guidance for the outer ring is provided by an integral flange at the head of the stud and a flange ring pressed onto the stud, or by the roller complement. Cam followers are pre-greased, ready-to-mount units that are suitable for all types of cam drives, tracks and conveyor systems.

SKF cam followers are available in three basic designs:

- KR design
- NUKR design
- PWKR design

All three cam follower designs have the same main dimensions. The differences are in their internal design, which make them suitable for various operating conditions.

All designs are available with a concentric seat (→ **fig. 18**) or an eccentric collar on the stud. An eccentric collar (→ **fig. 19**), which has a shrink-fit onto the stud, enables less stringent manufacturing tolerances to be specified for associated components. The values for the adjustable eccentricity are listed in the product tables.

Fig. 18

Cam follower with a concentric seat

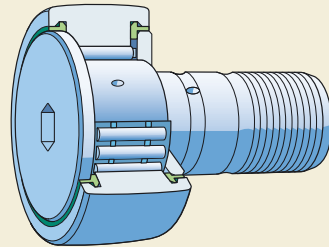

Fig. 19

Cam follower with an eccentric collar

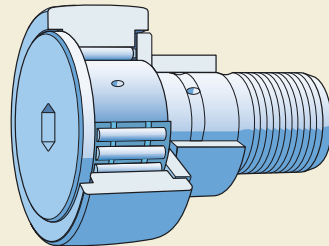
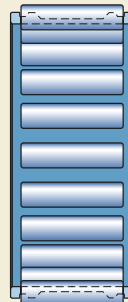

Fig. 20

Machined steel cage



KR design cam followers

KR design cam followers are fitted with a needle roller and cage assembly (→ **fig. 20**). The steel cage guides the rollers over their entire length, permitting relatively high-speed operation. The outer ring is guided axially by the pressed-on flange ring and the head of the stud, which also serves as an integral flange.

KR design cam followers without a designation suffix or with the designation suffix B (→ **fig. 21**) have a narrow gap between the outer ring and the two flanges and serves as a gap type seal.

KR design cam followers with the designation suffix PPA have axial sliding rings made of polyamide 66 (→ **fig. 22**). In the radial direction, the sliding ring forms a narrow labyrinth seal with the outer ring to protect against coarse contaminants. In the axial direction, the sliding ring serves as a contact seal to reliably retain grease in the bearing. This improves the lubrication conditions in the bearing, keeps friction and heat low, and extends grease service life.

Fig. 22

KR design cam follower, designation suffix PPA

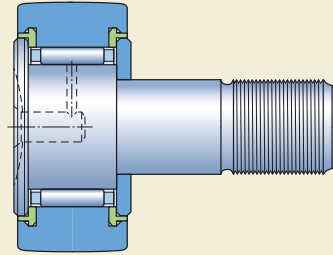

a) sizes 16 and 19

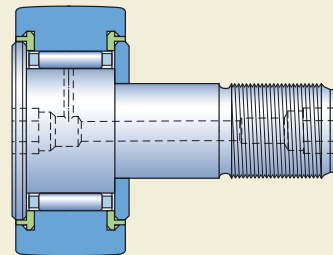

b) sizes 22 and 26

Fig. 21

KR design cam follower, designation suffix B, sizes 22 and 26

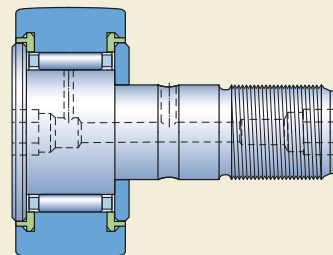
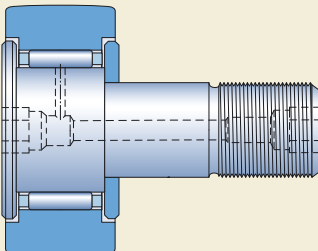

c) from size 30

Cam followers

KR design cam followers, sizes 16 and 19, either without a designation suffix or with the designation suffix PPA (→ **fig. 22a**, **page 239**), have one slot in the head of the stud that enables the stud to be held in place by a screwdriver during mounting. In the centre of that slot is a relubrication hole to press in a grease fitting or a plug if relubrication is not required. See section *Accessories*, starting on **page 244**. SKF also supplies these two sizes with a hexagon recessed into the head of the stud. They are fitted with sliding rings made of polyamide 66 and are identified by the designation suffix PPSKA. Cam followers with the designation suffix PPSKA are not equipped with a lubrication duct and cannot be relubricated (→ **fig. 23**).

KR design cam followers with the designation suffix B, sizes 22 and larger, have a recessed hexagon at each end of the stud. However, sizes 22 and 26 (→ **fig. 21**) do not have an annular groove and lubrication hole in the central part of the stud. In the centre of each hexagon is a relubrication hole to press in a grease fitting, if needed. Sizes 35 and larger can accommodate adapters from a central lubrication system. See section *Accessories*, starting on **page 244**. For cam followers from size 30 and larger, the lubricant can also be supplied via a relubrication hole with an annular groove in the seat.

KRE design cam followers

KRE design cam followers are similar to the KR design with a PPA designation suffix. The difference is that the KRE design has an eccentric collar pressed onto the stud (→ **fig. 24**). Because the eccentric collar covers the duct in the stud, these cam followers can only be relubricated via the stud ends.

KRV design cam followers

KRV design cam followers are similar to the KR design with a designation suffix PPA. The difference is that the KRV design has a full complement of needle rollers (→ **fig. 25**). Therefore, KRV design cam followers can accommodate heavier radial loads than KR design cam followers. However, they are not able to operate at the same high speeds and require more frequent relubrication.

Fig. 23

KR design cam follower, designation suffix PPSKA

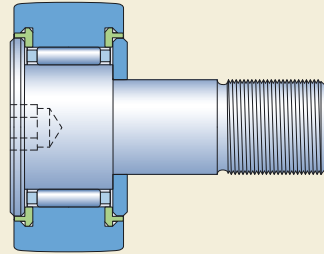

Fig. 24

KRE design cam follower, designation suffix PPA, sizes 30 and larger

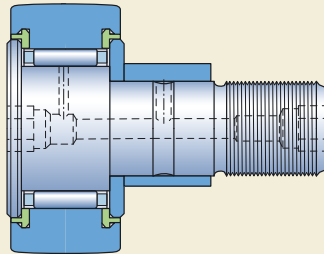
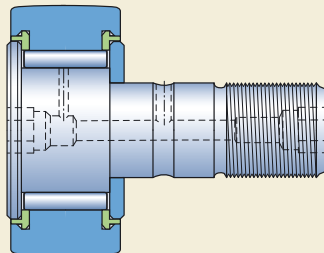

Fig. 25

KRV design cam follower, designation suffix PPA, sizes 30 and larger



NUKR design cam followers

NUKR .. A design cam followers

NUKR .. A design cam followers (→ **fig. 26**) are based on the design of a double row, full complement cylindrical roller bearing. The outer ring has two integral flanges that guide the roller complements axially. The stud head and a pressed-on flange ring provide axial guidance for the outer ring via the rollers. This enables NUKR .. A design cam followers to accommodate the heavy axial forces that result when operating in an inclined or tilted position and to operate at relatively high speeds.

NUKR .. A design cam followers have a recessed hexagon at each end of the stud, to enable the cam follower to be held in place by a hexagonal key (Allen wrench) during mounting. In the centre of each hexagon is a relubrication hole for a press-in grease fitting or an adapter from a central lubrication system. See section *Accessories*, starting on **page 244**. Lubricant can also be applied via the relubrication hole and the annular groove in the seat.

Sheet metal angle rings that are pressed into the outer ring and extend over the stud head and the flange ring form efficient labyrinth seals.

NUKRE .. A design cam followers

NUKRE .. A design cam followers are similar to the NUKR .. A design. The difference is that the NUKRE .. A design has an eccentric collar pressed onto the stud (→ **fig. 27**). Because the eccentric collar covers the duct in the stud, these cam followers can only be relubricated via the stud ends.

Fig. 26

NUKR .. A design cam follower

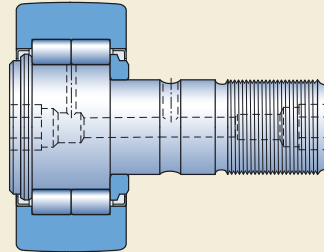
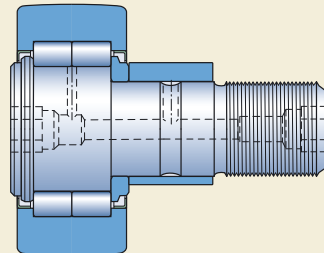

Fig. 27

NUKRE .. A design cam follower



PWKR design cam followers

PWKR ...2RS design cam followers

PWKR ...2RS design cam followers (→ fig. 28) have an outer ring with three integral flanges. They axially guide the two rows of full complement rollers separately to minimize friction in the cam follower, thereby reducing the amount of heat generated by the bearing. The stud head and a pressed-on flange ring provide axial guidance for the outer ring via the rollers. This enables the cam followers to accommodate the relatively heavy constant axial loads that occur when cam followers operate in an inclined position.

PWKR ...2RS design cam followers have a contact seal of oil and wear-resistant acrylonitrile-butadiene rubber (NBR) on both sides. The seals are integral with the angle rings that are pressed in the outer ring and seal against the stud head and the flange ring. The sheet metal angle rings extend over the stud head and the flange ring to form secondary labyrinth seals, making them particularly suitable for operation under arduous conditions.

The large space between the two rows of rollers enables a large quantity of grease to be incorporated. The large grease fill and efficient sealing method make it possible to operate PWKR ...2RS design cam followers for longer periods between maintenance intervals than was previously possible, even under contaminated conditions.

They also have a recessed hexagon at both ends of the stud that enables the cam follower to be held in place by a hexagonal key (Allen wrench) during mounting. In the centre of each hexagon is a relubrication hole for a press-in grease fitting or an adapter from a central lubrication system. See section *Accessories*, starting on **page 244**. Lubricant can also be applied via the relubrication hole and the annular groove in the seat.

PWKRE ...2RS design cam followers

PWKRE ...2RS design cam followers are similar to PWKR ...2RS design cam followers. The difference is that the PWKRE ...2RS design has an eccentric collar pressed onto the stud (→ fig. 29). Because the eccentric collar covers the lubrication duct in the stud, these cam followers can only be relubricated via the stud ends.

Fig. 28

PWKR ...2RS design cam follower

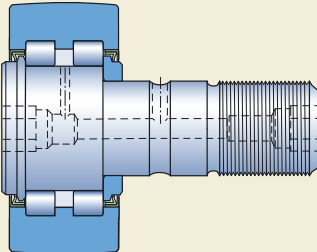
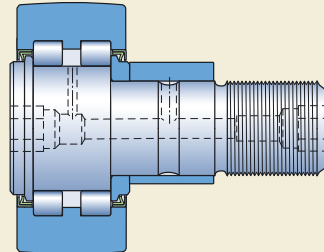

Fig. 29

PWKRE ...2RS design cam follower



Profile of the outer ring running surface

Crowned outer ring running surface

SKF supplies cam followers, as standard, with a crowned outer ring running surface. The crowned outer ring running surface provides good load distribution during operation when the bearing is in a tilted or inclined position.

KR design cam followers, without designation suffix or with designation suffix B, have a crowned running surface with a radius of 500 mm.

SKF also supplies cam followers with an improved crowned profile of the outer ring running surface. The modified line contact provides even better load distribution than cam followers with the standard radius. In practice, this modified line contact provides a higher degree of stiffness while reducing wear between the outer ring running surface and the track. The following cam follower designs have an improved crowned profile:

- KR design, with the designation suffixes PPA and PPSKA
- NUKR design
- PWKR design

Cylindrical outer ring running surface

SKF recommends cam followers with a cylindrical (flat) outer ring running surface for applications requiring a high degree of stiffness and when running in a tilted or inclined position can be avoided. They are identified by the designation suffix X. These cam followers are dimensionally interchangeable with standard profile cam followers. For additional information, contact the SKF application engineering service.

Cam followers

Accessories

The accessories (→ **table 4**) are intended to provide SKF cam followers with reliable lubrication and location. SKF supplies grease fittings and hexagonal nuts with the cam followers as standard, however, other accessories must be ordered separately.

Grease fittings

SKF supplies grease fittings that can be pressed into position, with each cam follower as standard (→ **table 4**). These are the only grease fittings that should be used. Dimensions are listed in **table 2**.

Note

For KR design cam followers, sizes 16 and 19, the head of the grease fitting protrudes from the head end of the stud by 1,5 mm.

Hexagonal nuts

SKF supplies the appropriate hexagonal nuts with each cam follower as standard. They are in accordance with ISO 4032:1999 or ISO 8673:1999. These 8.8 strength class nuts are zinc galvanized to ISO 4042:1999. Dimensions and recommended tightening torques are listed in **table 3**.

Table 2

Grease fittings

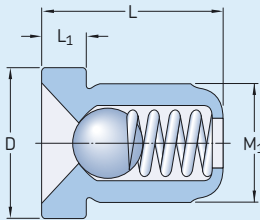

Designation	Dimensions			
	M ₁	D	L	L ₁

mm

NIP A1	4	6	6	1,5
NIP A1×4,5	4	4,7	4,5	1
NIP A2×7,5	6	7,5	7,5	2
NIP A3×9,5	8	10	9,5	3

Table 3

Hexagonal nuts

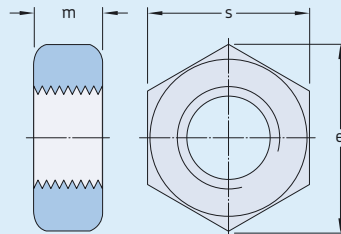

Size	Dimensions			Tightening torque	Standard ¹⁾
	m	e	s		

mm Nm -

M 6×1	5,2	11	10	3	1
M 8×1,25	6,8	14,4	13	8	1
M 10×1	8,4	17,8	16	15	2
M 12×1,5	10,8	20	18	22	2
M 16×1,5	14,8	26,8	24	58	2
M 18×1,5	15,8	29,6	27	87	2
M 20×1,5	18	33	30	120	2
M 24×1,5	21,5	39,5	36	220	2
M 30×1,5	25,6	50,9	46	450	2

¹⁾ 1 = EN ISO 4032:2001, ISO 4032:1999
2 = EN ISO 8673:2001, ISO 8673:1999

Table 4

Accessories for cam followers

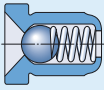

Grease fitting



Plug

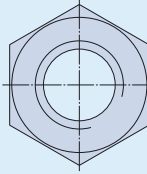

Hexagonal nut

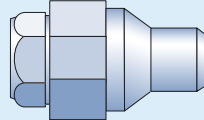

Adapter

Cam follower Design	Size without seals	with seals	Supplied with cam follower		To be ordered separately	
			Grease fitting	Hexagonal nut	Plug	Adapter
KR KRE KRV	16	16 PPA	NIP A1	M 6 × 1	VD1	–
	–	16 PPSKA	–	M 6 × 1	–	–
	19	19 PPA	NIP A1	M 8×1,25	VD1	–
	–	19 PPSKA	–	M 8×1,25	–	–
	22 B	22 PPA	2 × NIP A1×4,5	M 10×1	–	–
	26 B	26 PPA	2 × NIP A1×4,5	M 10×1	–	–
	30 B	30 PPA	2 × NIP A1×4,5	M 12×1,5	–	–
	32 B	32 PPA	2 × NIP A1×4,5	M 12×1,5	–	–
	35 B	35 PPA	2 × NIP A2×7,5	M 16×1,5	–	AP 8
	40 B	40 PPA	2 × NIP A2×7,5	M 18×1,5	–	AP 8
	–	47 PPA	2 × NIP A2×7,5	M 20×1,5	–	AP 10
	–	52 PPA	2 × NIP A2×7,5	M 20×1,5	–	AP 10
	–	62 PPA	2 × NIP A3×9,5	M 24×1,5	–	AP 14
	–	72 PPA	2 × NIP A3×9,5	M 24×1,5	–	AP 14
	–	80 PPA	2 × NIP A3×9,5	M 30×1,5	–	AP 14
–	90 PPA	2 × NIP A3×9,5	M 30×1,5	–	AP 14	
NUKR .. A NUKRE .. A PWKR ...2RS PWKRE ...2RS	–	35	2 × NIP A2×7,5	M 16×1,5	–	AP 8
	–	40	2 × NIP A2×7,5	M 18×1,5	–	AP 8
	–	47	2 × NIP A2×7,5	M 20×1,5	–	AP 10
	–	52	2 × NIP A2×7,5	M 20×1,5	–	AP 10
	–	62	2 × NIP A3×9,5	M 24×1,5	–	AP 14
	–	72	2 × NIP A3×9,5	M 24×1,5	–	AP 14
	–	80	2 × NIP A3×9,5	M 30×1,5	–	AP 14
	–	90	2 × NIP A3×9,5	M 30×1,5	–	AP 14

Cam followers

Plugs

The end of the relubrication hole in the stud of KR design cam followers, sizes 16 and 19, except those with the designation suffix PPSKA, can be plugged if relubrication is not required and if there is no space for the head of the grease fitting. Appropriate plugs with a VD1 designation must be ordered separately. The plug should be pressed into place using a mandrel (→ fig. 30).

Adapters for connecting to a centralized lubrication system

AP design adapters enable cam followers to be relubricated via a centralized lubrication system. These adapters have a quick connection that accommodates, for example, 4x0,75 polyamide tubing in accordance with DIN 73378:1996 (→ fig. 31). The designs and dimensions are listed in table 5.

Dimensions

The dimensions of SKF cam followers are in accordance with ISO 7063:2003 and ANSI/ABMA Standard 18.1-1982.

Table 5

Dimensions of adapters for connecting to a centralized lubrication system

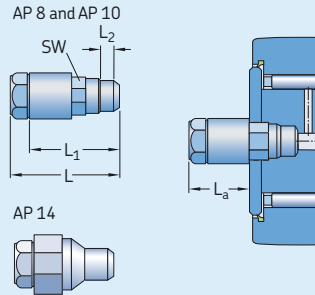

Designation	Dimensions				
	L	L ₁	L ₂	L _a	SW
–	mm				
AP 8	27	22	4	16	8
AP 10	27	22	5	15	10
AP 14	25	20	6	8	14

Fig. 30

Inserting the VD1 plug with a mandrel

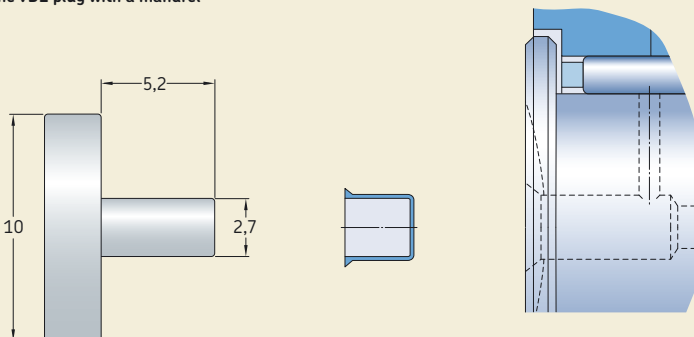

Tolerances

The tolerances of KR, KRE and KRV design cam followers are in accordance with ISO 7063:2003. Other SKF cam followers are made to Normal tolerances in accordance with ISO 492:2002. Exceptions are:

- the tolerance of the outside diameter running surface with a crowned profile, which is 0/-0,050 mm
- the tolerance of the stud shank diameter, h7 tolerance class
- the tolerance for the eccentric collar diameter, h9 tolerance class

The limits for h7 and h9 tolerance classes are listed in **table 6**.

Internal clearance

SKF supplies cam followers with a C2 radial internal clearance.

The clearance values are listed in **table 7** on **page 42** and are in accordance with ISO 5753:1991.

Table 6

ISO tolerance classes

Nominal diameter		h7		h9	
over	incl.	Deviations		Deviations	
		high	low	high	low
mm		µm		µm	
3	6	0	-12	0	-30
6	10	0	-15	0	-36
10	18	0	-18	0	-43
18	30	0	-21	0	-52
30	50	0	-25	0	-62

Fig. 31

Adapter for connection to centralized lubrication system

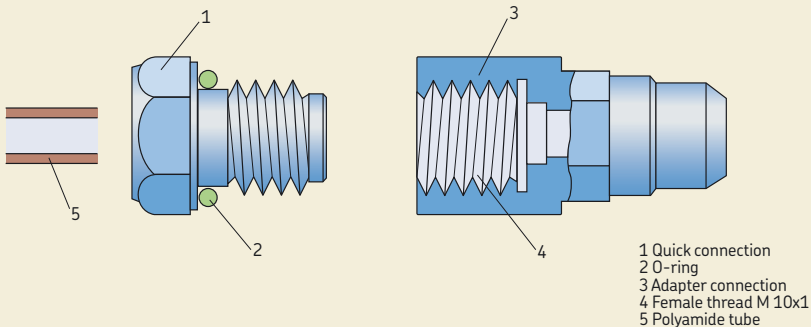

Load carrying capacity

Compared to a typical rolling bearing, where the outer ring is fully supported in a housing, a cam follower has only a small contact area between its outer ring running surface and the track. The actual contact area depends on the applied radial load and whether the running surface is crowned or flat. The deformation of the outer ring, caused by this limited contact, alters the force distribution in the bearing, which affects load carrying capacity. The basic load ratings listed in the product tables take this into account.

The ability to accommodate dynamic loads depends on the requisite life, but it is also important to consider the strength of the outer ring, therefore, the value of the maximum dynamic radial load F_r should not be exceeded.

The permissible static load for a cam follower is determined by the smaller of the values F_{0r} and C_0 . If requirements for smooth running are below normal, the static load may exceed C_0 but should never exceed the maximum permissible static radial load F_{0r} .

Permissible operating temperature

Generally, the permissible temperature range for cam followers is -30 to $+140$ °C. However, exceptions due to the seal material are:

- -30 to $+100$ °C for KR design, designation suffixes PPSKA and PPA
- -30 to $+120$ °C for PWKR ...2RS and PWKRE ...2RS design

Exceptions due to the applied grease must also be taken into account.

For additional information about temperature restrictions, refer to the sections *Cage materials* (→ page 44) and *Lubrication* (→ page 52).

Lubrication

All cam followers are filled at the factory with a high-quality grease with good corrosion inhibiting properties.

Although SKF cam followers require little maintenance, they must be relubricated to achieve their full service life. This can be done via ducts in the stud (→ fig. 32):

Fig. 32

Possibilities for relubrication

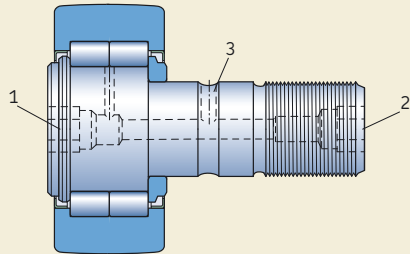

- from the head (bearing) end of the stud (1)
- from the thread end of the stud (2)
- through the relubrication hole and the annular groove in the seat on the stud shank (3)

Exceptions are:

- KR design cam followers, sizes 16 and 19, without a designation suffix or with a designation suffix PPA, which can only be relubricated via the head end
- KR design cam followers, sizes 16 and 19, designation suffix PPSKA, which cannot be relubricated
- KRE, NUKRE and PWKRE design cam followers, which can only be relubricated via the stud ends
- KR design cam followers, sizes 22 and 26, designation suffixes B or PPA, which can only be relubricated via the stud ends

SKF recommends relubrication while the initial grease fill still has its full lubricating properties. Cam followers used in applications where there are light loads, relatively low speeds and clean surroundings, can operate for long periods before relubrication is required. Cam followers that operate under contaminated and damp conditions, at high speeds or at temperatures above $+70$ °C, require frequent relubrication. Full complement KRV and NUKR design cam followers require more frequent relubrication. SKF recommends using SKF LGWA 2 grease for relubrication.

Supported flange ring

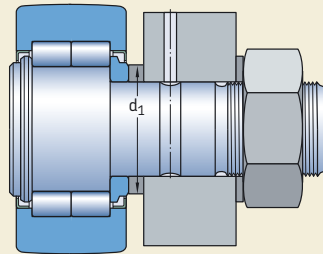

For additional information and characteristics (→ **table 1, page 54**) of the initial grease fill and SKF LGWA 2 grease, refer to the section *Lubrication*, starting on **page 52**.

For cam followers from size 35 and larger, the lubrication ducts are also suitable for connection to a central lubrication system. See section *Accessories*, starting on **page 244**.

Design of associated components

The flange ring that is pressed onto the stud shank should be supported axially over its entire side face. The support surface should have a diameter according to diameter d_1 (→ **fig. 33**). The bore through which the stud is attached should be machined to H7 tolerance class.

Mounting instructions

Cam followers can be attached to associated components (→ **fig. 33**) using the hexagonal nuts (→ **table 3, page 244**) supplied together with the cam follower. Spring washers, which are not supplied by SKF, serve to secure the nuts.

Cam followers that are subjected to shock loads should be mounted without clearance between the stud and its bore seat. The nuts should be tightened according to the recommended torque values listed in **table 3 on page 244**. The recommended tightening torques enable the full load carrying capacity of the cam follower to be exploited. If the requisite tightening torque cannot be achieved, the stud should be mounted with an interference fit.

Most cam followers (all from size 22) have recessed hexagons and can be held with a hexagonal key (Allen wrench) while the nut is being tightened. Some designs of sizes 16 and 19 have a slot in the stud head end and can be held with a screwdriver. For additional information, refer to the illustrations in the product tables, starting on **page 252**.

Depending on the mounting conditions, cam followers with an eccentric collar can be adjusted to the required eccentricity via the slot or the recessed hexagon.

Do not hit the head of the stud as damage to the cam follower may result.

SKF recommends positioning the lubrication hole in the stud head in the unloaded zone of the cam follower. The position of this hole corresponds to the SKF trademark on the head end of the stud.

The lubrication hole (→ position 3 in **fig. 32, page 248**) that is in line with the lubrication hole in the stud head may be used to incorporate a locking device to prevent the stud from turning, or can be used for relubrication purposes. This is only possible with cam followers that do not have an eccentric collar and with KR design cam followers from size 30 and larger.

Cam followers

Supplementary designations

The designation suffixes used to identify certain features of SKF cam followers are explained in the following.

- .2RS** Contact seal of acrylonitrile-butadiene rubber (NBR) on both sides of the cam follower
- A** NUKR design cam followers with an improved crowned profile of the outer ring running surface
- B** KR design cam followers with a crowned profile of the outer ring running surface and a recessed hexagon on both ends of the stud
- PPA** KR design cam followers with a polyamide 66 axial sliding and sealing ring on both sides. Improved crowned profile of the outer ring running surface. Sizes 16 and 19 have one slot in the head of the stud as standard. Size 22 and larger have a recessed hexagon on both ends.
- PPSKA** KR design cam followers, sizes 16 and 19, with a polyamide 66 axial sliding and sealing ring on both sides, improved crowned profile of the outer ring running surface and hexagon recessed into the head of the stud. These cannot be relubricated.
- PPXA** Cam followers with PPA features except for the outer ring running surface, which has a cylindrical profile
- X** Cylindrical (flat) profile of the outer ring running surface
- XA** NUKR .. A and NUKRE .. A design cam followers with a cylindrical (flat) profile of the outer ring running surface

Cam followers
D 16 – 32 mm

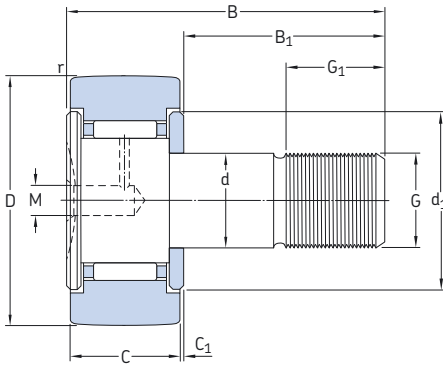

KR, sizes 16 and 19
(KR .. PPA, sizes 16 and 19
are with axial sliding rings)

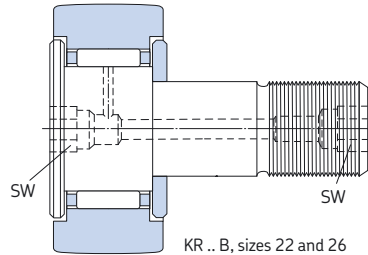
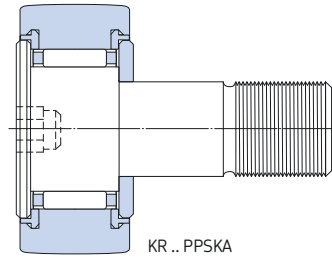

KR .. B, sizes 22 and 26
(KR .. PPA, sizes 22 and 26
are with axial sliding rings)

Dimensions

Mass

Designation

D	C	d	B	B ₁	B ₂	C ₁	d ₁	G	G ₁	M	M ₁	r _{min}	SW	c	B ₃	Mass	Designation
mm																kg	-
16	11	6	28	16	-	0,6	12,5	M 6	8	4	-	0,15	-	-	-	0,018	KR 16
	11	6	28	16	-	0,6	12,5	M 6	8	4	-	0,15	-	-	-	0,018	KR 16 PPA
	11	6	28	16	-	0,6	12,5	M 6	8	4	-	0,15	4	-	-	0,018	KR 16 PPSKA
	11	6	28	16	-	0,6	12,5	M 6	8	4	-	0,15	-	-	-	0,019	KRV 16 PPA
	11	9	28	16	-	0,6	12,5	M 6	8	4	-	0,15	-	0,5	7	0,02	KRE 16 PPA
19	11	8	32	20	-	0,6	15	M 8	10	4	-	0,15	-	-	-	0,029	KR 19
	11	8	32	20	-	0,6	15	M 8	10	4	-	0,15	-	-	-	0,029	KR 19 PPA
	11	8	32	20	-	0,6	15	M 8	10	-	-	0,15	4	-	-	0,029	KR 19 PPSKA
	11	8	32	20	-	0,6	15	M 8	10	4	-	0,15	-	-	-	0,031	KRV 19 PPA
	11	11	32	20	-	0,6	15	M 8	10	4	-	0,15	-	0,5	9	0,032	KRE 19 PPA
22	12	10	36	23	-	0,6	17,5	M 10×1	12	-	-	0,3	5	-	-	0,045	KR 22 B
	12	10	36	23	-	0,6	17,5	M 10×1	12	-	-	0,3	5	-	-	0,043	KR 22 PPA
	12	10	36	23	-	0,6	17,5	M 10×1	12	-	-	0,3	5	-	-	0,045	KRV 22 PPA
	12	13	36	23	-	0,6	17,5	M 10×1	12	-	-	0,3	5	0,5	10	0,047	KRE 22 PPA
26	12	10	36	23	-	0,6	17,5	M 10×1	12	-	-	0,3	5	-	-	0,059	KR 26 B
	12	10	36	23	-	0,6	17,5	M 10×1	12	-	-	0,3	5	-	-	0,057	KR 26 PPA
	12	10	36	23	-	0,6	17,5	M 10×1	12	-	-	0,3	5	-	-	0,059	KRV 26 PPA
	12	13	36	23	-	0,6	17,5	M 10×1	12	-	-	0,3	5	0,5	10	0,062	KRE 26 PPA
30	14	12	40	25	6	0,6	23	M 12×1,5	13	-	3	0,6	6	-	-	0,092	KR 30 B
	14	12	40	25	6	0,6	23	M 12×1,5	13	-	3	0,6	6	-	-	0,088	KR 30 PPA
	14	12	40	25	6	0,6	23	M 12×1,5	13	-	3	0,6	6	-	-	0,091	KRV 30 PPA
	14	15	40	25	6	0,6	23	M 12×1,5	13	-	3	0,6	6	0,5	11	0,093	KRE 30 PPA
32	14	12	40	25	6	0,6	23	M 12×1,5	13	-	3	0,6	6	-	-	0,1	KR 32 B
	14	12	40	25	6	0,6	23	M 12×1,5	13	-	3	0,6	6	-	-	0,1	KR 32 PPA
	14	12	40	25	6	0,6	23	M 12×1,5	13	-	3	0,6	6	-	-	0,1	KRV 32 PPA
	14	15	40	25	6	0,6	23	M 12×1,5	13	-	3	0,6	6	0,5	11	0,1	KRE 32 PPA

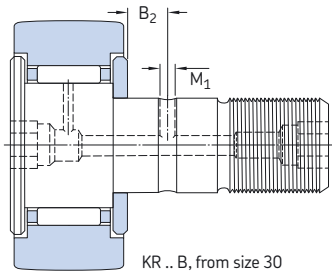

KR .. B, from size 30

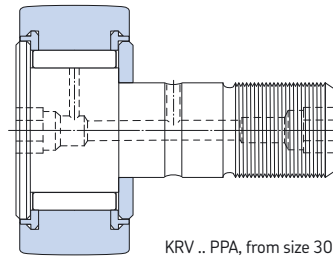

KRV .. PPA, from size 30

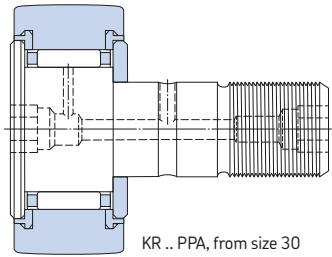

KR .. PPA, from size 30

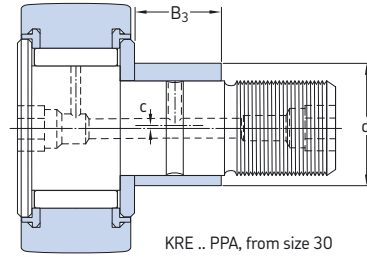

KRE .. PPA, from size 30

Designation	Basic load ratings		Fatigue load limit	Maximum radial loads		Limiting speed
	dynamic	static		dynamic	static	
	C	C ₀	P _u	F _r	F _{0r}	
–	kN		kN	kN		r/min
KR 16	0,415	3,14	0,345	2,9	4,15	6 000
KR 16 PPA	0,415	3,14	0,345	2,9	4,15	6 000
KR 16 PPSKA	0,415	3,14	0,345	2,9	4,15	6 000
KRV 16 PPA	0,965	4,73	0,72	4,05	5,7	4 300
KRE 16 PPA	0,415	3,14	0,345	2,9	4,15	6 000
KR 19	0,51	3,47	0,415	3,8	5,5	5 600
KR 19 PPA	0,51	3,47	0,415	3,8	5,5	5 600
KR 19 PPSKA	0,51	3,47	0,415	3,8	5,5	5 600
KRV 19 PPA	1,22	5,28	0,88	5,1	7,35	4 000
KRE 19 PPA	0,51	3,47	0,415	3,8	5,5	5 600
KR 22 B	0,735	4,4	0,56	4,25	6	5 300
KR 22 PPA	0,735	4,4	0,56	4,25	6	5 300
KRV 22 PPA	1,5	6,05	1,04	5,7	8,15	3 600
KRE 22 PPA	0,735	4,4	0,56	4,25	6	5 300
KR 26 B	0,735	4,84	0,655	9,3	13,2	5 300
KR 26 PPA	0,735	4,84	0,655	9,3	13,2	5 300
KRV 26 PPA	1,5	6,82	1,25	11,4	16,3	3 600
KRE 26 PPA	0,735	4,84	0,655	9,3	13,2	5 300
KR 30 B	1,1	6,44	0,88	7,8	11,2	4 800
KR 30 PPA	1,1	6,44	0,88	7,8	11,2	4 800
KRV 30 PPA	2,2	8,97	1,66	11	15,6	3 200
KRE 30 PPA	1,1	6,44	0,88	7,8	11,2	4 800
KR 32 B	1,1	6,71	0,95	10,6	15	4 800
KR 32 PPA	1,1	6,71	0,95	10,6	15	4 800
KRV 32 PPA	2,2	9,35	1,76	14,3	20,4	3 200
KRE 32 PPA	1,1	6,71	0,95	10,6	15	4 800

Cam followers
D 35 – 52 mm

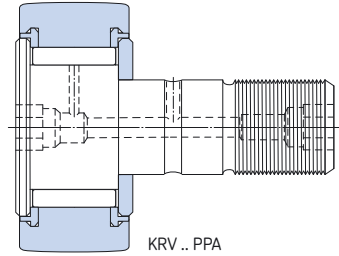
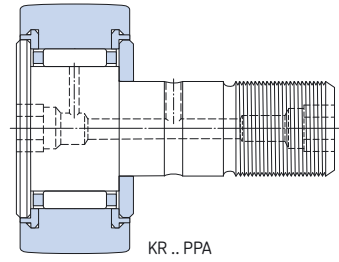
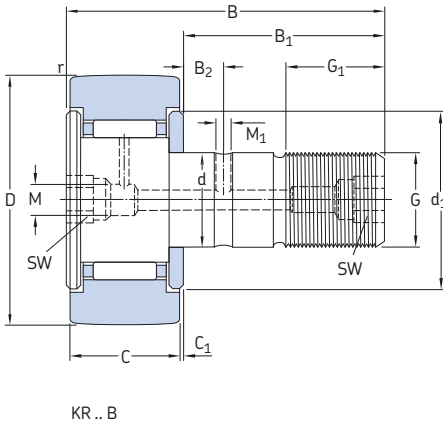

Dimensions															Mass	Designation		
D	C	d	B	B ₁	B ₂	C ₁	d ₁	G	G ₁	M	M ₁	r _{min}	SW	c	B ₃			
mm																kg	-	
35	18	16	52	32,5	8	0,8	27,6	M16×1,5	17	-	3	0,6	8	-	-	0,17	KR 35 B	
	18	16	52	32,5	8	0,8	27,6	M16×1,5	17	-	3	0,6	8	-	-	0,16	KR 35 PPA	
	18	16	52	32,5	8	0,8	27,6	M16×1,5	17	-	3	0,6	8	-	-	0,17	KRV 35 PPA	
	18	16	52	32,5	8	0,8	20	M16×1,5	17	6	3	0,6	8	-	-	0,16	NUKR 35 A	
	18	16	52	32,5	8	0,8	20	M16×1,5	17	6	3	0,6	8	-	-	0,16	PWK 35.2RS	
	18	20	52	32,5	8	0,8	27,6	M16×1,5	17	-	3	0,6	8	1	14	0,18	KRE 35 PPA	
	18	20	52	29,5	8	3,8	27,6	M16×1,5	17	6	3	0,6	8	1	12	0,18	NUKRE 35 A	
	18	20	52	29,5	8	3,8	27,6	M16×1,5	17	6	3	0,6	8	1	12	0,18	PWKRE 35.2RS	
	40	20	18	58	36,5	8	0,8	31,5	M18×1,5	19	-	3	1	8	-	-	0,25	KR 40 B
20		18	58	36,5	8	0,8	31,5	M18×1,5	19	-	3	1	8	-	-	0,25	KR 40 PPA	
20		18	58	36,5	8	0,8	31,5	M18×1,5	19	-	3	1	8	-	-	0,25	KRV 40 PPA	
20		18	58	36,5	8	0,8	22	M18×1,5	19	6	3	1	8	-	-	0,24	NUKR 40 A	
20		18	58	36,5	8	0,8	22	M18×1,5	19	6	3	1	8	-	-	0,24	PWK 40.2RS	
20		22	58	36,5	8	0,8	31,5	M18×1,5	19	-	3	1	8	1	16	0,26	KRE 40 PPA	
20		22	58	33,5	8	3,8	30	M18×1,5	19	6	3	1	8	1	14	0,26	NUKRE 40 A	
20		22	58	33,5	8	3,8	30	M18×1,5	19	6	3	1	8	1	14	0,26	PWKRE 40.2RS	
47		24	20	66	40,5	9	0,8	36,5	M20×1,5	21	8	4	1	10	-	-	0,38	KR 47 PPA
	24	20	66	40,5	9	0,8	36,5	M20×1,5	21	8	4	1	10	-	-	0,39	KRV 47 PPA	
	24	20	66	40,5	9	0,8	27	M20×1,5	21	6	4	1	10	-	-	0,38	NUKR 47 A	
	24	20	66	40,5	9	0,8	27	M20×1,5	21	6	4	1	10	-	-	0,38	PWK 47.2RS	
	24	24	66	40,5	9	0,8	36,5	M20×1,5	21	8	4	1	10	1	18	0,41	KRE 47 PPA	
	24	24	66	40,5	9	0,8	27	M20×1,5	21	6	4	1	10	1	18	0,4	NUKRE 47 A	
	24	24	66	40,5	9	0,8	27	M20×1,5	21	6	4	1	10	1	18	0,4	PWKRE 47.2RS	
	52	24	20	66	40,5	9	0,8	36,5	M20×1,5	21	8	4	1	10	-	-	0,45	KR 52 PPA
		24	20	66	40,5	9	0,8	36,5	M20×1,5	21	8	4	1	10	-	-	0,46	KRV 52 PPA
24		20	66	40,5	9	0,8	31	M20×1,5	21	8	4	1	10	-	-	0,45	NUKR 52 A	
24		20	66	40,5	9	0,8	31	M20×1,5	21	8	4	1	10	-	-	0,45	PWK 52.2RS	
24		24	66	40,5	9	0,8	36,5	M20×1,5	21	8	4	1	10	1	18	0,47	KRE 52 PPA	
24		24	66	40,5	9	0,8	31	M20×1,5	21	8	4	1	10	1	18	0,47	NUKRE 52 A	
24		24	66	40,5	9	0,8	31	M20×1,5	21	8	4	1	10	1	18	0,47	PWKRE 52.2RS	

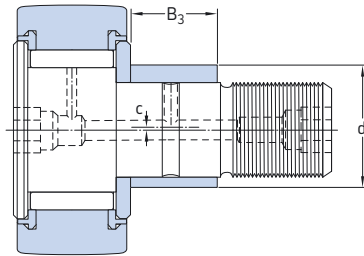

KRE .. PPA

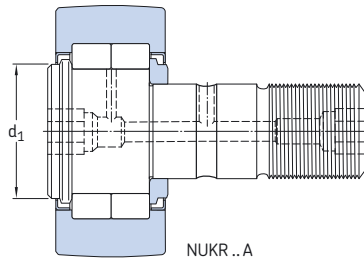

NUKR .. A
(NUKRE .. A have an eccentric collar)

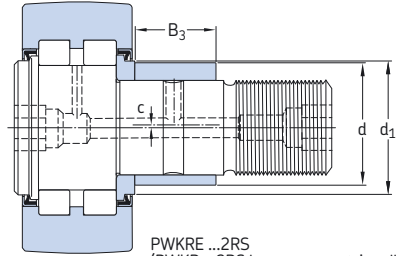

PWKRE ...2RS
(PWKR ...2RS have a concentric collar)

Designation	Basic load ratings		Fatigue load limit	Maximum radial loads		Limiting speed
	dynamic C	static C ₀		dynamic F _r	static F _{0r}	
–	kN		kN	kN		r/min
KR 35 B	2,2	9,52	1,56	11,4	16,3	4 000
KR 35 PPA	2,2	9,52	1,56	11,4	16,3	4 000
KRV 35 PPA	4,05	12,3	2,7	14,6	20,8	2 600
NUKR 35 A	3,25	16,8	2	8,65	12,2	5 000
PWKR 35.2RS	1,9	11,9	1,2	8,65	12,5	5 000
KRE 35 PPA	2,2	9,52	1,56	11,4	16,3	4 000
NUKRE 35 A	3,25	16,8	2	8,65	12,2	5 000
PWKRE 35.2RS	1,9	11,9	1,2	8,65	12,5	5 000
KR 40 B	2,4	10,5	1,73	12,5	18	3 400
KR 40 PPA	2,4	10,5	1,73	12,5	18	3 400
KRV 40 PPA	4,65	14,2	3,1	17	24,5	2 200
NUKR 40 A	3,65	19	2,5	14	20	4 500
PWKR 40.2RS	2,16	13,8	1,5	13,7	19,6	4 500
KRE 40 PPA	2,4	10,5	1,73	12,5	18	3 400
NUKRE 40 A	3,65	19	2,5	14	20	4 500
PWKRE 40.2RS	2,16	13,8	1,5	13,7	19,6	4 500
KR 47 PPA	3,8	14,7	2,9	23,6	33,5	3 000
KRV 47 PPA	7,2	19,4	5	30,5	43	1 900
NUKR 47 A	6	28,6	3,9	17,6	25	3 800
PWKR 47.2RS	4,3	22,9	2,8	18,3	26	3 800
KRE 47 PPA	3,8	14,7	2,9	23,6	33,5	3 000
NUKRE 47 A	6	28,6	3,9	17,6	25	3 800
PWKRE 47.2RS	4,3	22,9	2,8	18,3	26	3 800
KR 52 PPA	3,8	15,7	3,2	36	51	3 000
KRV 52 PPA	7,2	20,9	5,6	45	64	1 900
NUKR 52 A	7,2	29,7	4,25	18	25,5	3 200
PWKR 52.2RS	5,1	23,8	3,05	18,6	26,5	3 200
KRE 52 PPA	3,8	15,7	3,2	36	51	3 000
NUKRE 52 A	7,2	29,7	4,25	18	25,5	3 200
PWKRE 52.2RS	5,1	23,8	3,05	18,6	26,5	3 200

Cam followers
D 62 – 90 mm

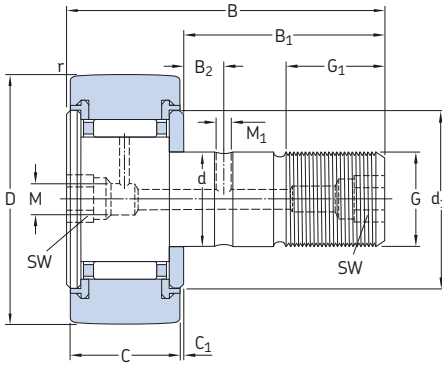

KR .. PPA

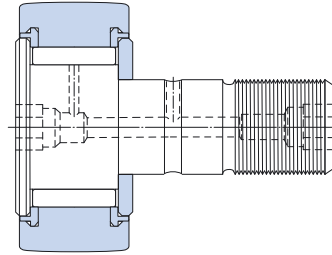

KRV .. PPA

Dimensions															Mass	Designation	
D	C	d	B	B ₁	B ₂	C ₁	d ₁	G	G ₁	M	M ₁	r _{min}	SW	c	B ₃		
mm															kg	-	
62	29	24	80	49,5	11	0,8	44	M 24×1,5	25	8	4	1	14	-	-	0,77	KR 62 PPA
	29	24	80	49,5	11	0,8	44	M 24×1,5	25	8	4	1	14	-	-	0,79	KRV 62 PPA
	28	24	80	49,5	11	1,3	38	M 24×1,5	25	8	4	1	14	-	-	0,8	NUKR 62 A
	28	24	80	49,5	11	1,3	38	M 24×1,5	25	8	4	1	14	-	-	0,8	PWKR 62.2RS
	29	28	80	49,5	11	0,8	44	M 24×1,5	25	8	4	1	14	1	22	0,8	KRE 62 PPA
	28	28	80	49,5	11	1,3	38	M 24×1,5	25	8	4	1	14	1	22	0,82	NUKRE 62 A
	28	28	80	49,5	11	1,3	38	M 24×1,5	25	8	4	1	14	1	22	0,82	PWKRE 62.2RS
72	29	24	80	49,5	11	0,8	44	M 24×1,5	25	8	4	1,1	14	-	-	1,01	KR 72 PPA
	29	24	80	49,5	11	0,8	44	M 24×1,5	25	8	4	1,1	14	-	-	1,03	KRV 72 PPA
	28	24	80	49,5	11	1,3	44	M 24×1,5	25	8	4	1,1	14	-	-	1,02	NUKR 72 A
	28	24	80	49,5	11	1,3	44	M 24×1,5	25	8	4	1,1	14	-	-	1,02	PWKR 72.2RS
	29	28	80	49,5	11	0,8	44	M 24×1,5	25	8	4	1,1	14	1	22	1,04	KRE 72 PPA
	28	28	80	49,5	11	1,3	44	M 24×1,5	25	8	4	1,1	14	1	22	1,05	NUKRE 72 A
	28	28	80	49,5	11	1,3	44	M 24×1,5	25	8	4	1,1	14	1	22	1,05	PWKRE 72.2RS
80	35	30	100	63	15	1	53	M 30×1,5	32	8	4	1,1	14	-	-	1,61	KR 80 PPA
	35	30	100	63	15	1	53	M 30×1,5	32	8	4	1,1	14	-	-	1,64	KRV 80 PPA
	35	30	100	63	15	1	47	M 30×1,5	32	8	4	1,1	14	-	-	1,6	NUKR 80 A
	35	30	100	63	15	1	47	M 30×1,5	32	8	4	1,5	14	-	-	1,6	PWKR 80.2RS
	35	35	100	63	15	1	53	M 30×1,5	32	8	4	1,1	14	1,5	29	1,67	KRE 80 PPA
	35	35	100	63	15	1	47	M 30×1,5	32	8	4	1,1	14	1,5	29	1,67	NUKRE 80 A
	35	35	100	63	15	1	47	M 30×1,5	32	8	4	1,5	14	1,5	29	1,67	PWKRE 80.2RS
90	35	30	100	63	15	1	53	M 30×1,5	32	8	4	1,1	14	-	-	1,98	KR 90 PPA
	35	30	100	63	15	1	53	M 30×1,5	32	8	4	1,1	14	-	-	2	KRV 90 PPA
	35	30	100	63	15	1	47	M 30×1,5	32	8	4	1,1	14	-	-	1,96	NUKR 90 A
	35	30	100	63	15	1	47	M 30×1,5	32	8	4	1,5	14	-	-	1,96	PWKR 90.2RS
	35	35	100	63	15	1	53	M 30×1,5	32	8	4	1,1	14	1,5	29	2,03	KRE 90 PPA
	35	35	100	63	15	1	47	M 30×1,5	32	8	4	1,1	14	1,5	29	2,02	NUKRE 90 A
	35	35	100	63	15	1	47	M 30×1,5	32	8	4	1,5	14	1,5	29	2,02	PWKRE 90.2RS

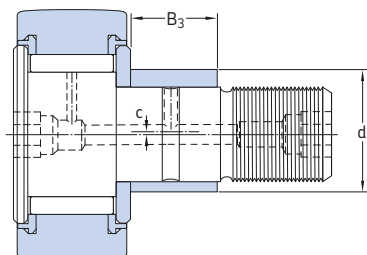

KRE .. PPA

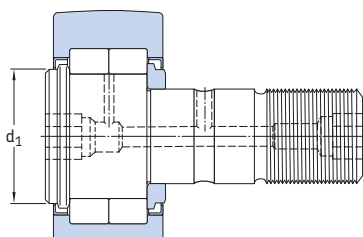

NUKR ... A
(NUKRE ... A have an eccentric collar)

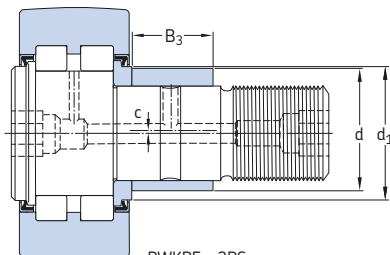

PWKRE ...2RS
(PWKR ...2RS have a concentric collar)

Designation	Basic load ratings		Fatigue load limit	Maximum radial loads		Limiting speed
	dynamic	static		dynamic	static	
	C	C ₀	P _u	F _r	F _{0r}	
–	kN		kN	kN		r/min
KR 62 PPA	6,55	24,6	5,5	58,5	85	2 400
KRV 62 PPA	11,4	31,4	9	72	102	1 700
NUKR 62 A	9,5	41,3	5,85	25	36	2 600
PWKR 62.2RS	7,35	31,9	4,05	20,4	29	2 600
KRE 62 PPA	6,55	24,6	5,5	58,5	85	2 400
NUKRE 62 A	9,5	41,3	5,85	25	36	2 600
PWKRE 62.2RS	7,35	31,9	4,05	20,4	29	2 600
KR 72 PPA	6,55	26	6	100	143	2 400
KRV 72 PPA	11,4	33	9,8	118	170	1 700
NUKR 72 A	11,2	45,7	7,1	34,5	50	2 000
PWKR 72.2RS	7,35	39,6	5,6	47,5	68	2 600
KRE 72 PPA	6,55	26	6	100	143	2 400
NUKRE 72 A	11,2	45,7	7,1	34,5	50	2 000
PWKRE 72.2RS	7,35	39,6	5,6	47,5	68	2 600
KR 80 PPA	10,6	36,9	9	106	150	1 800
KRV 80 PPA	17,6	45,7	14	122	176	1 400
NUKR 80 A	16,6	69,3	10,8	48	69,5	1 900
PWKR 80.2RS	13,2	57,2	9,3	64	91,5	2 000
KRE 80 PPA	10,6	36,9	9	106	150	1 800
NUKRE 80 A	16,6	69,3	10,8	48	69,5	1 900
PWKRE 80.2RS	13,2	57,2	9,3	64	91,5	2 000
KR 90 PPA	10,6	38	9,5	160	228	1 800
KRV 90 PPA	17,6	47,3	15	183	260	1 400
NUKR 90 A	16,6	78,1	12,7	86,5	125	1 900
PWKR 90.2RS	13,2	62,7	10,8	108	153	2 000
KRE 90 PPA	10,6	38	9,5	160	228	1 800
NUKRE 90 A	16,6	78,1	12,7	86,5	125	1 900
PWKRE 90.2RS	13,2	62,7	10,8	108	153	2 000

Product index

Designation	Product	Product table/ table	Page
AP	Adapters, accessories for cam followers	4	245
AS	Thrust washers	6.1, 6.2	162
AXK	Needle roller and cage thrust assemblies	6.1	162
AXW	Needle roller thrust bearings with a centring spigot	6.2	166
BK	Drawn cup needle roller bearings with a closed end	3.1	82
G	Radial shaft seals with a low cross sectional height	8.3	212
GS 811	Housing washers	6.1	163
HK	Drawn cup needle roller bearings with an open end	3.1	82
HN	Full complement drawn cup needle roller bearings with an open end	3.1	84
IR	Needle roller bearing inner rings	8.1	200
K	Needle roller and cage assemblies	2.1	64
KR	Cam followers	9.4	252
KRE	Cam followers, with an eccentric collar	9.4	252
KRV	Cam followers, with a full complement roller set	9.4	252
LR	Needle roller bearing inner rings	8.1	200
LS	Raceway washers	6.1, 6.2	163
NA 22	Support rollers without flange rings, with an inner ring	9.2	228
NA 48	Needle roller bearings with machined rings with flanges, with an inner ring	4.2	130
NA 49	Needle roller bearings with machined rings with flanges, with an inner ring	4.2	122
NA 69	Needle roller bearings with machined rings with flanges, with an inner ring	4.2	122
NAO	Needle roller bearings with machined rings without flanges, with an inner ring	4.4	138
NATR	Support rollers with flange rings, with an inner ring	9.3	230
NATV	Support rollers with flange rings, with an inner ring, with a full complement roller set	9.3	230
NK	Needle roller bearings with machined rings with flanges, without an inner ring	4.1	106
NKI	Needle roller bearings with machined rings with flanges, with an inner ring	4.2	122
NKIA 59	Needle roller / angular contact ball bearings	7.1	174
NKIB 59	Needle roller / angular contact ball bearings	7.1	174
NKIS	Needle roller bearings with machined rings with flanges, with an inner ring	4.2	122
NKS	Needle roller bearings with machined rings with flanges, without an inner ring	4.1	108
NKX	Needle roller / thrust ball bearings, thrust bearing with a cage	7.3	186
NKXR	Needle roller / cylindrical roller thrust bearings	7.4	192
NNTR	Support rollers with flange rings, with an inner ring	9.3	234
NUKR	Cam followers	9.4	254
NUKRE	Cam followers, with an eccentric collar	9.4	254
NUTR	Support rollers with flange rings, with an inner ring	9.3	230
NX	Needle roller / thrust ball bearings, full complement thrust bearing	7.2	184
PNA	Alignment needle roller bearings with an inner ring	5.2	148
PWKR	Cam followers	9.4	254
PWKRE	Cam followers, with an eccentric collar	9.4	254
PWTR	Support rollers with flange rings, with an inner ring	9.3	230
RN	Needle rollers	8.2	206
RNA 22	Support rollers without flange rings, without an inner ring	9.1	226
RNA 48	Needle roller bearings with machined rings with flanges, without an inner ring	4.1	118
RNA 49	Needle roller bearings with machined rings with flanges, without an inner ring	4.1	106
RNA 69	Needle roller bearings with machined rings with flanges, without an inner ring	4.1	106
RNAO	Needle roller bearings with machined rings without flanges, without an inner ring	4.3	134
RPNA	Alignment needle roller bearings without an inner ring	5.1	146
RSTO	Support rollers without flange rings, without an inner ring	9.1	226
SD	Radial shaft seals with a low cross sectional height	8.3	212
STO	Support rollers without flange rings, with an inner ring	9.2	228
VD1	Plug, accessory for cam followers	4	245
WS 811	Shaft washers	6.1, 6.2	163

